

# 2017 Full-Line Catalog

Building Professionals' Entry & Patio Door Directory

**THERMA TRU**<sup>®</sup>  
DOORS



• Home begins at the door.

# Table of Contents

**Introduction** ..... 2-31  
Door Systems ..... 4-5  
Door System Components ..... 6-7  
Door Selections ..... 8-15  
Decorative & Specialty Glass ..... 16-19  
The Therma-Tru Difference ..... 20-21  
Impact Products ..... 22-23  
Curb Appeal Inspiration ..... 24-29  
**NEW** Products ..... 30-31

**Classic-Craft**® ..... 32-109  
Decorative & Specialty Glass ..... 32-41  
Accessories ..... 42-43  
American Style Collection™ ..... 44-51  
Mahogany Collection™ ..... 52-63  
Rustic Collection™ ..... 64-79  
Oak Collection™ ..... 80-91  
Canvas Collection ..... 92-109

**Fiber-Classic® & Smooth-Star** ..... 110-201  
Decorative & Specialty Glass .... 114-122  
Accessories ..... 123

**Steel** ..... 202-226  
Profiles™ ..... 202, 204-220  
Traditions ..... 203-206, 221-226  
Decorative & Specialty Glass .... 205-206

**Fire Doors** ..... 227-231

**Pulse** ..... 232-245

**Hinged Patio** ..... 246-253

**Door System Components** ..... 254-263

**Same-Day® Stain Kit** ..... 264-265

**Special Quote Program** ..... 266

**3'6" Width Options Chart** ..... 269

**7'0" & 6'6" Height Options Charts** ..... 270-271

**Product Details** ..... 272-273

**Index** ..... 274-291

## NEW for 2017



**Smooth-Star Shaker-Style Doors & Sidelites**  
Page 30



**Grained & Smooth 3-1/2" Simulated Divided Lites**  
Page 31



**47" Internal Blinds**  
Page 174



**Grip-Style Multi-Point Locking System Handlesets**  
Page 260

\*Brand Use Study, 2016 *Builder* magazine.

Right Page: Classic-Craft Mahogany Collection, Ashurst Glass, Door – CCM893, Sidelites – CCM8002SL





# DISCOVER

## • Therma-Tru. You're in expert hands.

Choosing Therma-Tru isn't about just selecting a door. It's about designing an inspired entrance. Creating a look everyone will love. And having confidence that it will perform for years to come.

Whether it's Classic or Contemporary – or somewhere in between – Therma-Tru offers virtually unlimited choices to complement the architecture of a home and a homeowner's sense of style.

But it's more than beauty that makes Therma-Tru the brand building professionals prefer most.\* With more than 50 years of industry experience and technical know-how, we've built a reputation for delivering high-quality, low-maintenance exterior door products for the whole house – from entry to patio.

We invented the fiberglass door because we believe it combines the best characteristics of wood and steel – beauty and performance – without the compromises. And we remain committed to making smart, innovative new products that are better and more beautiful every year.

Whatever the entrance needs – from energy efficiency to security – your search ends here. You'll find a wide range of durable and reliable Therma-Tru products built to meet the needs of the home and the homeowner's lifestyle.

**That's where the beauty of choosing  
Therma-Tru begins.**

# Therma-Tru® Door Systems

Uncompromising quality, inside and out.



A Therma-Tru door with genuine Therma-Tru components is more than a beautiful door – it's a complete door system. One that offers uncompromising quality, inside and out. We manufacture or specify every aspect – from the glass to the hinges – all engineered with craftsman precision for durability and reliability through the years. So you can be confident that it will perform as exceptionally as it looks.

• Backed by our lifetime limited warranty.

## Lifetime Limited Warranty

We stand behind more parts and for longer than other door companies because we make or specify everything that goes into our door system. A Therma-Tru fiberglass door system is backed by the industry's most comprehensive lifetime limited warranty.



## Energy Efficiency

In any region or climate, energy efficiency is key. More than 80% of Therma-Tru door and glass options are ENERGY STAR® qualified and National Fenestration Rating Council (NFRC) certified, helping save money on energy costs.



## Quality Testing

Our doors, glass and components are held to high standards. We conduct thorough testing to help ensure that our products will live up to a homeowner's toughest quality and performance expectations.



## The Beauty of Choice

The architectural beauty of a Therma-Tru door is easy to see. With the look of real wood, rich panel details and intricate, handcrafted decorative glass designs, there are thousands of possibilities to suit the style of a home and express a homeowner's personal style.



### Door System Components

Have confidence in a door system made with genuine Therma-Tru components to meet the needs of many applications. More on pages 6–7.



### Door Selections

Find choices in design, texture and material with many configurations available to find the ideal door system. More on pages 8–15.



### Decorative & Specialty Glass

Complement any Therma-Tru door with a variety of glass shapes and designs. More on pages 16–19.



### Finish Options

Complete the desired look with stain or paint, including the Same-Day® Stain kit available in seven popular finish colors. More on pages 264–265.

## Selecting a Door System

Therma-Tru pays close attention to regional and consumer trends to deliver choices designed to inspire. Keep these considerations in mind when choosing from our portfolio of door system products:

- What is the size of the doorway?
- What is the style of the home?
- Does the homeowner want to stain or paint the door?
- How much light or privacy is desired?

Also consider:

- Regional weather conditions and building codes. See pages 22–23 for more.
- Therma-Tru 2017 new products. See pages 30–31 for more.



# Engineered to Work Together

Our complete door systems feature doors, glass and components engineered to work together to resist leaks and drafts, and help maintain energy efficiency and weather resistance.

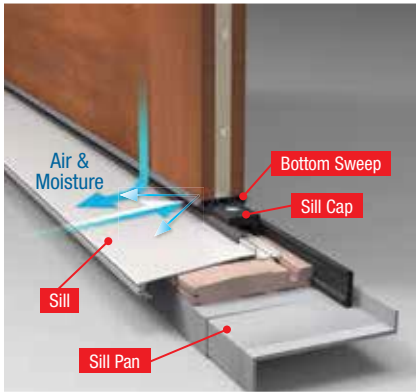

- 1 Sill and bottom sweep** form a tight seal against wind-driven moisture infiltration at the bottom of the door system and help channel moisture away from the home. **Sill pan** (recommended) adds an extra layer of protection to help keep moisture away from the subfloor.

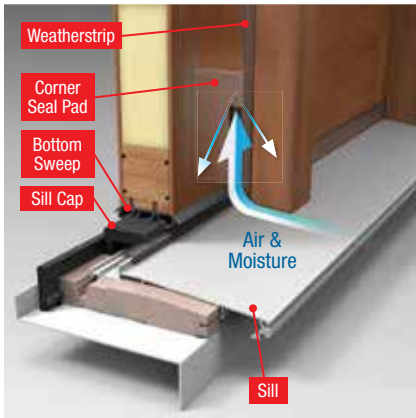

- 2 Corner seal pads** (inswing only) complete the seal between the **sill cap**, **bottom sweep** and **weatherstrip** to help block potential pathways where wind-driven moisture can infiltrate the bottom corner of the door system.

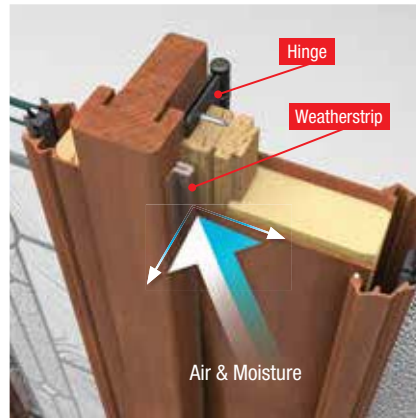

- 3 Hinges** position the **door** to properly compress the **weatherstrip** to help form a tight, even seal against air and moisture infiltration when the door closes.

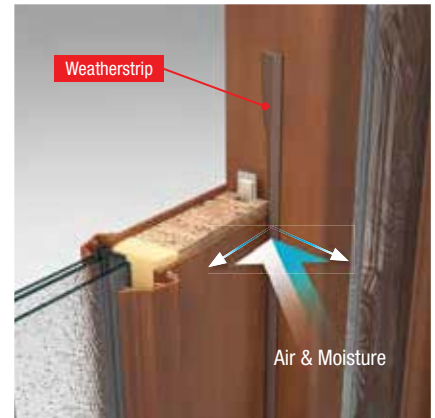

- 4 Weatherstrip** is specifically engineered in a variety of profiles to provide the best possible fit with our door systems, helping to deliver a precise seal between the **door and frame**.

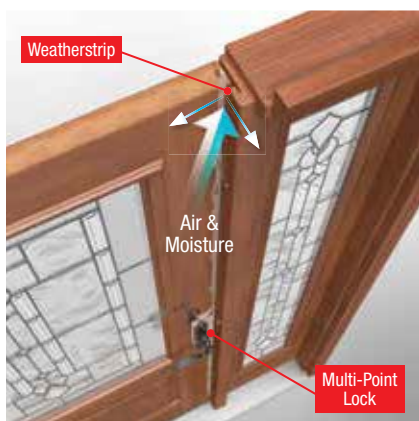

- 5 Multi-point locking system** (recommended) engages the **door** and **frame** at three points from top to bottom, helping to preserve the **weatherstrip's** seal even under wind pressure.

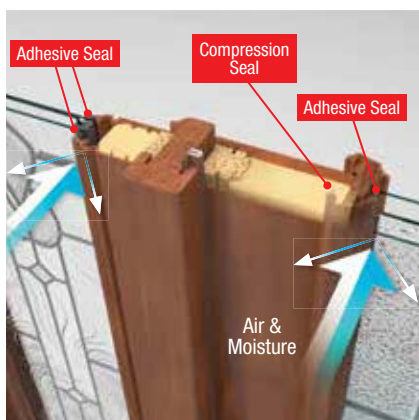

- 6 Lip-lite frame** (shown right) features a **compression seal** against weather on the outside of the **door** and an **adhesive seal** against weather on the outside of the **glass**. **Flush-glazed glass** (shown left) is built directly into the door without a Lip-lite frame, featuring a **high-performance adhesive weather seal** inside and out.

## A Complete Door System

More than beautiful doors and glass; a complete door system includes the components used to assemble it. We manufacture or specify every aspect of a complete door system. The Therma-Tru® genuine components shown here are our premium options for long-lasting durability.



### Composite Adjustable Sills

Inswing and outswing composite sills resist rotting and insects. Inswing adjustable sills help to maintain a tight seal over time.



### Dual-Bulb / Dual-Fin Bottom Sweeps

A dual-bulb, dual-fin design helps maintain tight contact with adjustable sill caps and creates added barriers against moisture.



### 7-Shape Corner Seal Pads

Innovative options include our patented jamb assembly, featuring the 7-shape corner seal pad which creates an air pocket that helps prevent a vacuum from wicking moisture up the weatherstrip.



### Removable Weatherstrip

Resilient design compresses when closed and springs back when open, protected by a durable jacket, for long-lasting sealing power.



### Multi-Point Locking Systems

(Recommended)

Increased engagement between door and frame enhances stability and the homeowner's sense of security.

(Highly recommended for 8'0" and double fiberglass doors. Not recommended for steel doors.)



### Ball-Bearing Hinges

Hinges with ball bearings protecting each hinge pivot, or "knuckle", offer added support and stability.

(Recommended for Classic-Craft doors, 8'0" doors, doors with glass, and Impact- and Fire-rated fiberglass doors.)



### Frame Components

Check with your Therma-Tru seller for options to complete the door system, including rot-resistant brickmould, jambs, mullions and coil cladding manufactured to our specifications.

For more, including these additional component options, see pages 256-265:

Sill Pans, Rain Protection, Strike Plate and Astragals.



## Tru-Defense: The Ultimate Protection

Therma-Tru fiberglass doors are available with our exclusive Tru-Defense system as an option. It integrates specific components engineered and tested to deliver outstanding protection in all kinds of weather conditions. And it's backed by a Warranty Rider that provides for cash reimbursement that may be used toward secondary damage to flooring and trim, and the labor to make repairs if water infiltration occurs.\* Look for the (⊕) icon. For details, visit [www.thermatru.com/trudefense](http://www.thermatru.com/trudefense).

### Water Infiltration Cash Reimbursement Limit

|   |                |
|---|----------------|
| Latch and Deadbolt Lock with Standard Assembly:   | \$250          |
| with a Therma-Tru Sill Pan:                       | \$500          |
| Multi-Point Lock with Standard Assembly:          | \$750          |
| with a Therma-Tru Sill Pan:                       | \$1,500        |
| Multi-Point Lock with NAFS-Certified Door System: | \$1,000        |
| with a Therma-Tru Sill Pan:                       | <b>\$2,000</b> |

\*The Rider does not warrant workmanship of anyone who assembles or installs a Tru-Defense door system, nor any damages caused by improper handling, assembly or installation.



# Door Selections

Choose from our many door selections to complement the architectural style of the home. The possibilities are endless from fiberglass and steel materials to wood-grained and smooth textures to stainable and paintable finishes.

## Classic-Craft® Collections Pages 32-109

Find the right style for any personality. Choose from premium fiberglass entryways in four wood grains or a smooth surface that all rival custom wood.

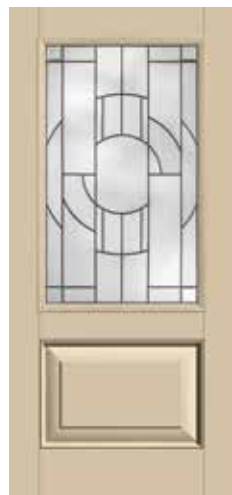

Both Classic-Craft and Fiber-Classic are rated a *Consumers Digest* Best Buy in the fiberglass entry doors category.

# Fiber-Classic® Collections Pages 110–201

The industry's first fiberglass door delivers the look and feel of real Mahogany and Oak with excellent performance and value.



**Mahogany Collection™**



**Oak Collection™**



# Smooth-Star® Pages 110–201

A smooth, ready-to-paint fiberglass door that offers excellent performance and value.



**Smooth-Star.**



# Steel Pages 202–226

Bring style and affordability together to create very attractive results with our steel doors.



**Profiles™**

**10 YEAR LIMITED WARRANTY**  
Door & Glass



**Traditions**

**5 YEAR LIMITED WARRANTY** Door  
**10 YEAR LIMITED WARRANTY** Glass

# Pulse® Pages 232–245

A contemporary series of door styles and glass designs that can be combined to make a bold statement.



Fiberglass



Steel



**Ari**



**Línea**

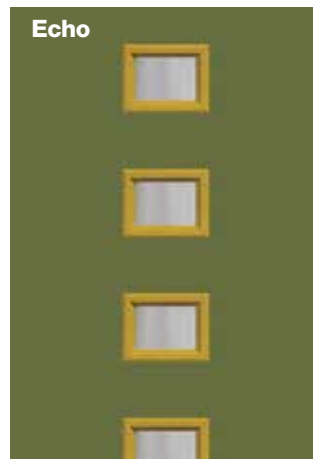

**Echo**





**See the difference.**

Discover architecturally correct designs, exclusive glass options and rich, authentic finishes.



**Feel the difference.**

Experience the integrity of a solid, precision-engineered entryway built for long-term durability, stability and peace of mind.

• Extraordinary in every way.





# Classic-Craft® Premium Entryways

A premium entryway that's truly unique and uncompromising in every detail. One that blends precision-engineered features with architecturally correct details to produce an entryway that performs as exceptionally as it looks – instilling confidence and peace of mind. And Classic-Craft entry doors are rated a *Consumers Digest* Best Buy for their exceptional warranty, quality of materials and construction, and resemblance to a real wood door.



## Compare for yourself.



**Premium – right down to the edge.**  
A solid hardwood square edge delivers a genuine wood appearance.

**Standard fiberglass bullnose edge.**  
The bullnose profile, typical of other fiberglass doors, detracts from the authentic wood look.



**The look of real wood.**  
Realistic wood grains that are virtually indistinguishable from high-grade wood doors, thanks to Therma-Tru's AccuGrain® technology.



**Details that define a custom door.**  
Crisp, handcrafted elegance creates embossments that are deeper than standard fiberglass doors.

**Architecturally correct for true classic beauty.**  
Doors designed to be architecturally correct, with proportions modeled after classic architectural principles, to create a more premium entryway.

Up to 25% wider panels\*



**Classic-Craft Premium Door**

**Standard Fiberglass Door**

\*Comparison of Classic-Craft to other standard fiberglass doors with similar styles. Visit [www.thermatru.com](http://www.thermatru.com) for details.  
Note: See your Therma-Tru seller or visit [www.thermatru.com](http://www.thermatru.com) for details on limited warranties and exclusions.  
Left Page: Classic-Craft Rustic Collection Door – CCR8222; Low-E Glass, Sidelite – CCR8000SL, ©TheHouseDesigners.com



- Find options to fit every entrance.



# Fiber-Classic® & Smooth-Star® Doors

Bring home the authentic look of wood with the low-maintenance benefits of fiberglass. From front entry to patio, you will find flexible options to fit virtually every entrance with beautiful, energy-efficient, durable and secure fiberglass doors. Choose from a wide range of door styles and sizes, glass designs, and options to meet building codes. And Fiber-Classic entry doors are rated a *Consumers Digest* Best Buy for their exceptional warranty, breadth of style options and wood-grained texture.



### Portfolio versatility.

With many door styles in common and interchangeable glass designs between collections, it allows flexibility to find the right door, in the right texture, without compromises.



### On-trend surfaces.

Available in a variety of textures, including grain choices with the look of real wood or a smooth, paintable alternative to steel. (Wood-grained images shown in Natural Oak stain.)



### High-definition panel embossments.

High-definition panel embossments are standard on all doors and sidelites.

Note: See your Therma-Tru seller or visit [www.thermatru.com](http://www.thermatru.com) for details on limited warranties and exclusions.

Left Page Top: Fiber-Classic Oak Collection, Salinas Glass, Door – 81955P, Sidelites – 81955PSL

Left Page Bottom Left: Smooth-Star, Screen Vented Lite, Door – S243

Left Page Bottom Right: Smooth-Star, Clear Glass, Door – S8140



# Door Construction

Therma-Tru fiberglass doors offer the authentic look of wood. It's virtually impossible to tell the difference. But the beauty goes beyond skin deep. We combine craftsmanship and innovation to build our doors for long-lasting energy efficiency, durability and security.

## Classic-Craft® Premium Entryways



### 1 Enhanced Weather Resistance

No more worries about rotting, warping or twisting. Classic-Craft premium entryways are tested and designed to resist extreme weather conditions and the damaging effects of moisture. Both the top and bottom of the door are protected by composite rails for a longer-lasting entryway.

### 2 Solid Security

Classic-Craft premium entryways feel solid and close with authority. A 4- $\frac{1}{8}$ " wide beam of engineered lumber runs from the top to the bottom of the locking side of the door to add mass and rigidity, giving the door weight and a natural wood feel.

### 3 Excellent Durability

Built to stand up to the elements and years of wear, Classic-Craft's fiberglass skins are thicker than other standard fiberglass doors to provide added durability and better long-term performance.

### 4 Higher R-Values

Classic-Craft premium entryways contribute to an energy-efficient home. A polyurethane foam core provides up to four times the insulating R-Value of wood.\*

### 5 Edge-to-Edge Moisture Protection

Resist moisture at every turn – and along every edge. Classic-Craft premium entryways have hardwood and composite edges that help prevent moisture penetration.

\*Comparison of fiberglass to wood doors (both without glass).

## Fiber-Classic® & Smooth-Star® Doors



### 1 Weather Resistance

Composite rails protect the door at the top and bottom edges to help block moisture that can wick into doors.

### 2 Security

An enhanced lock block combined with a 1- $\frac{1}{4}$ " engineered lumber lock stile increases rigidity and stability.

### 3 Durability

With very little maintenance, a fiberglass door can bring a home years of durability. Unlike wood, fiberglass will not warp or rot. And, unlike steel, it will not dent or rust.

### 4 R-Values

Built with a polyurethane foam core that offers up to four times the insulating R-Value of wood\*, Therma-Tru fiberglass doors insulate against cold and heat for exceptional energy efficiency.

# Decorative & Specialty Glass

A Therma-Tru door system with decorative glass can create an entrance that makes a statement — one that says the homeowner has high standards for style, quality and craftsmanship.

- Our wide array of glass designs, from simple to intricate, reflect the home design trends and homeowner desires of today and tomorrow.
- Numerous glass colors, textures, shapes and coming options are available to complement any door.
- Our glass designs are researched in the market to ensure they are highly rated in consumer preference.
- Our decorative glass is handcrafted and built with all-glass bevels for premium quality.
- Our glass designs offer varying levels of privacy and light to suit homeowner needs.
- All Low-E and clear glass panels are tempered to provide added safety.

Doors come to life with Therma-Tru® glass.

More than 10%  
wider glass\*



**Classic-Craft  
Premium Glass**

**Standard Glass**

\*Comparison of Classic-Craft to other standard fiberglass doors with similar styles. Visit [www.thermatru.com](http://www.thermatru.com) for details. Note: See your Therma-Tru seller or visit [www.thermatru.com](http://www.thermatru.com) for details on ENERGY STAR qualified products.

## Classic-Craft® Premium Entryways

- An exclusive collection of 13 decorative glass families, starting on page 32.
- Close attention to detail produces truly distinctive designs you won't find anywhere else.
- More than 10% wider glass\* welcomes more light into the home and creates a distinctive entryway.
- Fiberglass lite frames are made with the same material as the door to blend seamlessly with the rest of the entryway when stained or painted.
- All sidelites are made with flush-glazed glass for a truly seamless, consistent appearance.
- All clear glass options are Low-E, providing long-term energy efficiency.





### Special Quote Program

Don't sacrifice the look you want. With thousands of standard glass choices and additional glass options available through special quote, we can help you find the right look for virtually any home. See page 266.



Contributes to an energy-efficient home.



### Triple-Pane Construction

All triple-pane decorative, as well as privacy and textured, glass panels are enclosed between tempered glass, offering superior quality and thermal performance.

### Fiber-Classic® & Smooth-Star® Doors

- A portfolio of 14 interchangeable decorative glass designs, starting on page 114.
- Invite light into the home for a more brilliant interior with 22" wide glass in a Lip-lite frame, as well as flush-glazed options with 25–27" wide glass – starting on page 163.
- Scrolled profile lite frames are heat and fade resistant, and suitable for use with a storm door.
- Low-E glass is available for internal blinds, divided lites and clear glass, providing exceptional energy efficiency.

## Privacy & Textured Glass

Therma-Tru® doors and sidelites can be fitted with our beautiful privacy and textured glass. This versatile assortment aligns with personal style and homeowner desires for privacy while allowing natural light to brighten the interior.

- Category includes diverse textures for individual design expression.
- Varying opacity levels range from 8–10.
- All privacy and textured glass options are triple-pane, providing thermal efficiency.
- Triple-pane construction also allows for an easy-to-clean surface.
- Available with two Lip-lite frame options, as well as seamless flush-glazed options, in select doors.

Available in Classic-Craft®, Fiber-Classic®, Smooth-Star®, Profiles™, Traditions and Pulse® doors and sidelites.



## Convenient choices for more light.

### Low-E Glass

Factory-coated Low-E glass delivers exceptional energy efficiency. Available in Classic-Craft, Fiber-Classic, Smooth-Star, Profiles, Traditions and Pulse. Look for the ☀ icon.



In cold weather, Low-E glass can help reduce the loss of heat by reflecting the heat back inside the home.

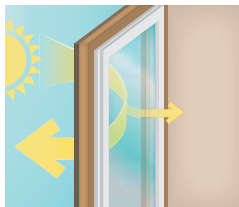

In warm weather, Low-E glass reflects the sun's rays off of the glass, helping to keep the interior of the home cool.

### Flush-Glazed Glass

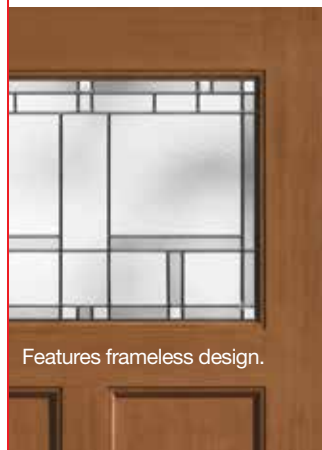

Features frameless design.

Glass built directly into the door during the manufacturing process eliminates the need for a lite frame and provides a high-performance weather seal. Flush-glazed glass features clean lines and eliminates the need for screw plugs. It also offers up to a 16% increase in visible glass area compared to conventional lite frames.

Available in Classic-Craft, Fiber-Classic and Smooth-Star.

Look for the ☀ icon. See page 122 for more.

## Internal Blinds

Enjoy the privacy and convenience of a cordless blind enclosed between glass. Control the desired level of light and privacy with the simplicity of a single handle.

- Protected between two panes of tempered glass for enhanced safety and performance.
- With no dangling cords, this is a kid- and pet-friendly choice.
- Blinds remain dust free, and glass is easier to clean than traditional blinds.
- Choose Low-E glass for maximum energy efficiency or standard clear glass.

Available in Fiber-Classic®, Smooth-Star®, Profiles™, Traditions and Pulse® doors and sidelites.



## Divided Lites

Enhance the beauty of any home with a variety of divided lite options for entry and patio doors. Tailor the look with different texture, profile and color choices. See pages 120–121 for more.

- Coordinate with the home's window patterns for a cohesive look and increased curb appeal.
- Choose from Colonial, Craftsman or Prairie styles to suit the home's architectural details.
- Available glass options include elegant privacy and textured, as well as energy-efficient Low-E and clear.



# Discover the Therma-Tru Difference

## Classic-Craft® Canvas Collection.



### • The premium smooth, paintable choice.

For years, Classic-Craft premium entryways have defined beauty and durability for fiberglass doors. The innovative Canvas Collection delivers a high-performing alternative to custom wood and heavy-gauge steel. These doors pair durable Classic-Craft construction with crisp embossments and custom wood details. Find choices to match any home décor with a smooth surface that's paintable inside and out, and available in more than 375 door and glass combinations.

- The aesthetics of wood and the performance of fiberglass in a smooth, paintable door.
- Extraordinary in every detail with precision-engineered features and architecturally correct details.

- The largest line of door and glass combinations available in any Classic-Craft collection.
- Classic-Craft is rated a *Consumers Digest* Best Buy for the fiberglass entry door category.
- Available in many styles and sizes – including 8'0" heights – to complement more home styles.

See the collection, starting on page 92.



Fire-Rated Options Tru-Defense Eligible WBDR / HVHZ Options

Note: See your Therma-Tru seller or visit [www.thermatru.com](http://www.thermatru.com) for details on limited warranties and exclusions, Tru-Defense Rider and ENERGY STAR qualified products.

Top: Classic-Craft Canvas Collection, Homeward Glass, Door – CCV9926, Sidelites – CCV911SL

# Discover the Therma-Tru Difference

## Vented Sidelites



### Ventilation and aesthetics second to none.



#### Perfect for the front entry.

- Enjoy the added curb appeal of an elegant front entry unobstructed by a screen door.
- Choose eye-catching, decorative glass designs to complement the front entry door selection.

Therma-Tru reinvented sidelites to meet the needs of homeowners seeking ventilation, convenience and aesthetics. Keep the incredible look of the entry or patio door system without sacrificing the pleasure of a fresh breeze. There's no need to cover the door with a screen. Choose beautiful vented sidelites instead. And only Therma-Tru offers vented sidelites with decorative glass design options.

- Works as a small swinging door with sturdy stiles to accommodate hinges, multi-point locking system and thumbturn.
- Wide patio mullions provide required structural strength for years of dependable operation.

- Continuous system, recessed strike plates and multi-point locking gears provide security and stability.
- Convenient, removable screens – available in bronze and white – are easy to operate and designed for years of worry-free use.

Available in Fiber-Classic and Smooth-Star, starting on page 110.



Tru-Defense Eligible

Note: See your Therma-Tru seller or visit [www.thermatru.com](http://www.thermatru.com) for details on limited warranties and exclusions, Tru-Defense Rider and ENERGY STAR qualified products.

Top: Smooth-Star, Clear Glass with SDLs, Doors – S2000-4C, Sidelites – S2000SL-4C

Bottom: Fiber-Classic Oak Collection, Saratoga Glass, Door – FC905, Sidelites – FC815SL

# Tough When You Need It. Beautiful Always.

## High-Power Testing

Our Impact-rated doors pass a large missile impact test. We blast a 9 lb. 2" x 4" stud into the doors at 34 mph to prove they're the better choice for strength and stability.

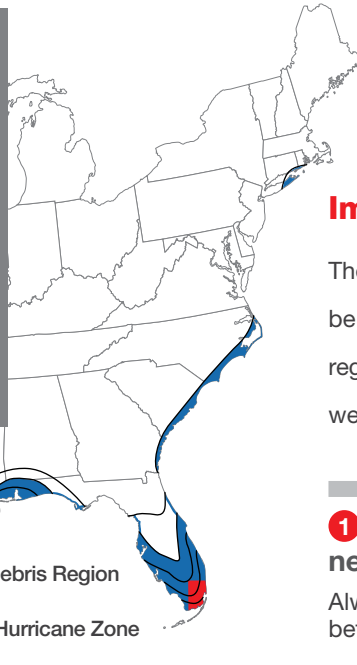

■ Wind-Borne Debris Region (WBDR)  
■ High Velocity Hurricane Zone (HVHZ)







## Impact-Rated Products

Therma-Tru offers Impact-rated doors and glass that can be used to meet high-wind and coastal region codes and regulations, offering excellent performance in extreme weather conditions while providing added protection.

### 1 Use the map as a guide to find out if you need product for WBDR or HVHZ.

Always confirm building code requirements in your area before buying.\*

### 2 Use the icons to find available Therma-Tru® product options in this catalog.

|  |   |  |   |   |  |
|--|---|--|---|---|--|
| <br><b>STRUCTURAL DOOR</b> | + | <br><b>IMPACT GLASS</b>  | = | <br><b>WBDR Option</b> | <p>Designed to withstand wind forces up to 167 mph (DP-50). (ASTM E 1886 / ASTM E 1996)</p> <p>Structural Fiberglass Door + Impact Laminated Glass with Impact Lip-Lite Frame = WBDR Option</p>            |
| <br><b>IMPACT DOOR</b>    | + | <br><b>IMPACT GLASS</b> | = | <br><b>HVHZ Option</b> | <p>Designed to withstand wind forces up to 175 mph (DP-55). (TAS 201 / TAS 203)</p> <p>Impact Steel-Plate Reinforced Fiberglass Door + Impact Laminated Glass with Impact Lip-Lite Frame = HVHZ Option</p> |

 **WBDR / HVHZ Options:** Look for this icon to find door and sidelite styles that can be configured for WBDR or HVHZ.

### 3 Verify that there is a Therma-Tru product approval specific to your area for the door system configuration before buying.\*

### 4 Make sure the product is installed in compliance with the product approval to meet building codes.

The performance of the door system depends on how it is installed. Proper installation is required to comply with building codes.

\*Product approvals show that the door system meets applicable codes when selected, assembled and installed as instructed. Note: See your Therma-Tru seller or visit [www.thermatru.com](http://www.thermatru.com) for product approvals and installation instructions. Always confirm building code requirements in your area before buying. Follow weather and news reports to assess severe weather situations and obey local authorities' shelter and evacuation orders. No product guarantees safety for persons or property, nor makes any premises hurricane- or impact-proof.



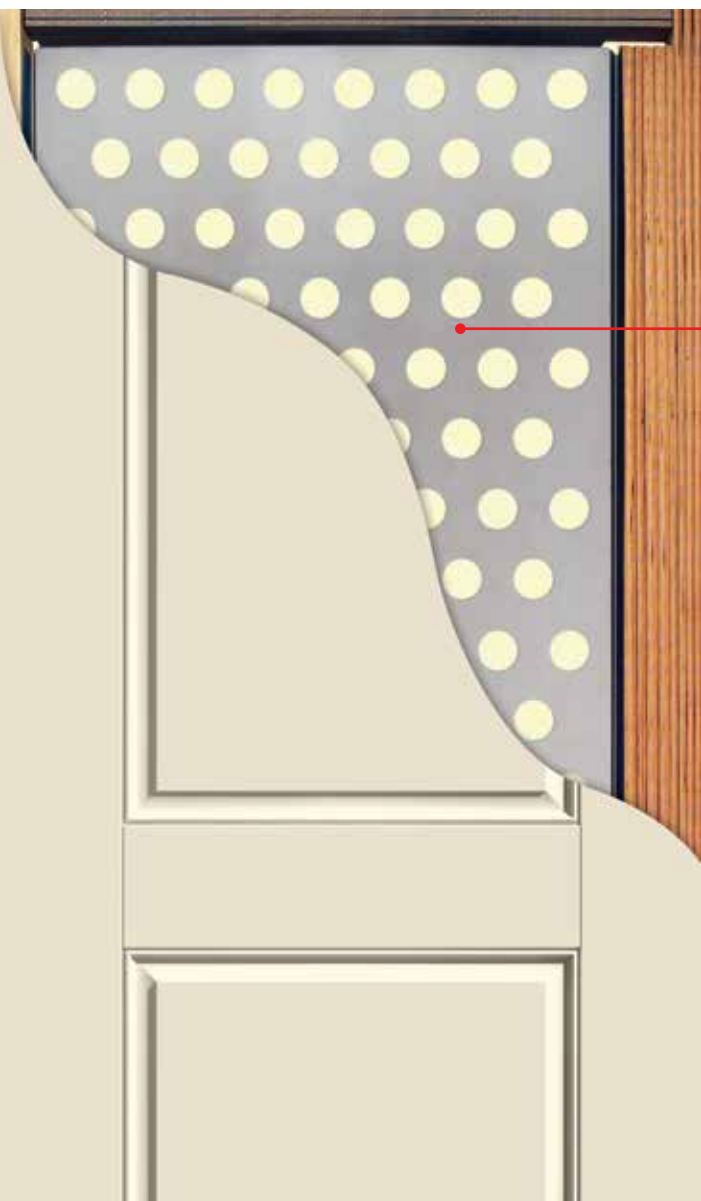

Constructed to help protect the interior of the home from flying debris and high winds associated with tropical storms and hurricanes, these products are tested to meet codes and regulations in coastal regions, including parts of Florida, Texas and the Carolinas.\*

### Impact Doors

Feature a built-in 24-gauge steel plate lining.



### Impact Glass

Features special laminated glass construction.

### Impact Lip-Lite Frame

Features durable, paintable aluminum construction.

An attractive scrolled profile gives a thin, sleek appearance and a screw channel cover helps hide unsightly screws.



## Other Considerations

### Fire Doors

We offer an industry-leading selection of fiberglass 20-Minute Fire-rated doors – with 20- and 90-Minute Fire-rated steel options available – for protection with a sense of style. See pages 227–231.

### Noise Reduction Doors

Therma-Tru Sound Transmission Class- (STC) rated Noise Reduction doors deliver aesthetics with a commercial level of performance for residential projects. See page 200.

# The Power of Curb Appeal



Before



After



## \$18,750

A smart investment, a new Therma-Tru entry door can increase a home's perceived value by 4.2% or \$18,750 on average.\*<sup>1</sup>

24



## 10 SEC.

Potential homebuyers will form an opinion about a home's value within 10 seconds of seeing it in person.<sup>2</sup>



## 90%

90% of homebuyers will look at photos of homes on the Internet, making curb appeal a show stopper.<sup>2</sup>

• Now that's a smart investment.

### Builders

This is the ideal time for you and your customers to think about entry door size. There are many ways to complement a home's style with unique door and glass designs from Therma-Tru.

### Remodelers

There are so many ways to renovate a home. But adding a stunning new Therma-Tru entry door is one sure way to help homeowners add curb appeal.

Open the door to increased value with a stylish new Therma-Tru door. Learn more at [www.thermatru.com/curbappeal](http://www.thermatru.com/curbappeal).

<sup>1</sup>[www.thermatru.com](http://www.thermatru.com) <sup>2</sup>[www.about.com](http://www.about.com)

\*Based on a nationwide survey of consumers' estimates of perceived home value based on exterior appearance. Not based on actual home sales. Results may vary based on region and home style. Therma-Tru's "National Home Valuation Study" was commissioned by Therma-Tru in 2015 and conducted by TNS, an independent provider of internet-based research.



# Get Inspired



## Choose entry doors by design.

With a wide array of door styles, Therma-Tru has something for everyone. New for 2017, the Architectural Home Styles Guide pairs stylish Therma-Tru doors with popular home design trends, giving you confidence that your door selection will add curb appeal while enhancing the home's architectural style. Turn the page for a preview.

■ Download the full Architectural Home Styles Guide at [www.homestyles.thermatru.com](http://www.homestyles.thermatru.com).



Top: Classic-Rustic Collection, Zaha Glass, Door – CCR1851, Sidelites – CCR1851SL





# Colonial

Preserves the classic style of homes from America's history. Known for its formal design and symmetry.



Left: Classic-Craft Rustic Collection, Provincial Glass, Doors – CCR804028

# European

Inspired by the provincial style of countryside estates. Features rich details on brick, stone and stucco exteriors.



Right: Classic-Craft Mahogany Collection, Lucerna Glass, Door – CCM898, Sidelites – CCM8102SL



## Victorian

Reflects the style of this grand period with elaborate detail. Marked by its asymmetry and textured exteriors.



Left: Classic-Craft Canvas Collection, Arcadia Glass, Door – CCV05029, Sidelites – CCV109SL, Transom – CC620T

## Craftsman

Exemplifies the craft of building by hand. Emphasized by the use of natural wood, stone and brick materials.



Right: Classic-Craft American Style Collection, Arborwatch Glass with SDLs, Door – CCA9300, Sidelites – CCA9100SL





## Southwest

Includes breezy spaces practical for warm climates. Feels exotic with stucco exteriors and stone accents.



Left: Classic-Craft Canvas Collection, Augustine Glass, Door – CCV806027

## Traditional

Combines practicality with classic looks in almost any form. Represents elements from a variety of styles.



Right: Classic-Craft Oak Collection, Cambridge Glass, Door – CC96, Sidelites – CC2044SL





# Coastal

Mixes traditional details and clean lines for casual elegance. Blends indoor and outdoor living with great views.



Left: Fiber-Classic Mahogany Collection, Maple Park Glass, Door – FCM900

# Modern

Focuses on clean lines and asymmetrical exteriors. Fuses together industrial concrete, vinyl and glass materials.

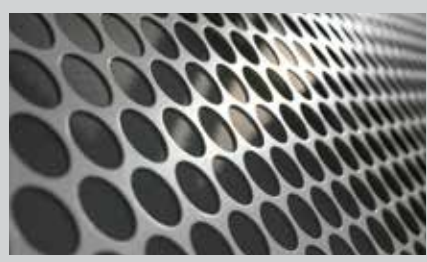

Right: Pulse Echo, Granite Glass with Scrolled Lite Frame, Door – S85XN, Sidelite – S85XNSL



**NEW**

# Smooth-Star®

## New Shaker-Style Doors & Sidelites



30

### Relaxed style for simple living.

A transitional update to the historic Shaker style, new Smooth-Star Shaker-style doors and sidelites feature flush-glazed glass and recessed panels delivering a simple design with broad appeal. Ideal for homes that take design cues from Farmhouse, Prairie and Modern architectural elements, Shaker-style doors and sidelites bridge the gap between yesterday's styles and today's trends.

Available in Smooth-Star, starting on page 165.

#### Flush-Glazed Fiberglass Door Replacement Rider

Provides protection in case of accidental glass breakage during residential and multi-family construction or installation. Therma-Tru will replace the flush-glazed fiberglass door and sidelite.



Note: To learn more about availability, call 1-800-323-3533. See your Therma-Tru seller or visit [www.thermatru.com](http://www.thermatru.com) for details on limited warranties and exclusions, Rider and ENERGY STAR qualified products.

Top: Smooth-Star, Low-E Glass with SDLs, Door – S4814, Sidelites – S4812SL

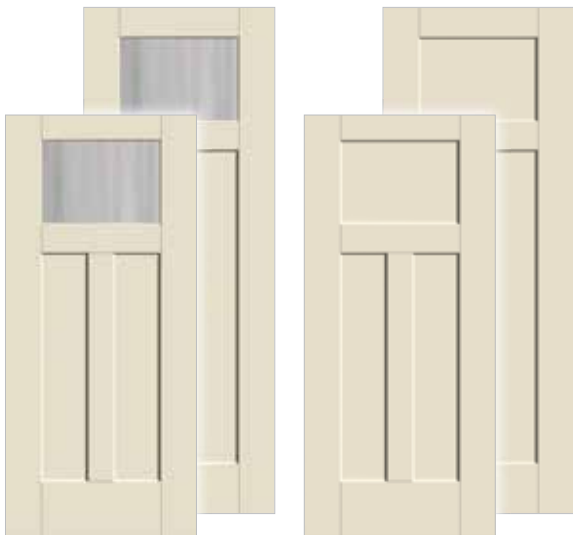

Craftsman-Lite 2-Panel  
Shaker Flush-Glazed

2-Panel  
Craftsman Shaker



**NEW**

# Simulated Divided Lites

New 3-1/2" Wide Bars



• Flush-glazed with modern appeal.

### SDL Bar Options\*



3-1/2"  
**Buff Grained**  
(Shown in Natural Oak.)



3-1/2"  
**White Smooth**

### Glass Shapes & Grid Patterns



Add contemporary style to the entry with 3-1/2" wide simulated divided lite (SDL) bars. Designed to pair with flush-glazed doors and sidelites, this addition to the SDL portfolio features a flat profile to complement the seamless appearance of flush-glazed privacy and textured, Low-E and clear glass for a clean, sleek look.

Available in Fiber-Classic. Oak Collection™ and Smooth-Star®, starting on page 164. Look for the (🐾) icon.



\*Not recommended for use behind storm doors or to be painted dark colors, if exposed to direct sunlight.

Note: See your Therma-Tru seller or visit [www.thermatru.com](http://www.thermatru.com) for details on available product sizes and options, limited warranties and exclusions, and ENERGY STAR qualified products.

Top: Smooth-Star, Clear Glass with SDLs, Door – S85720



# Classic-Craft® Decorative & Specialty Glass Designs

## Villager™

Villager beautifully interprets the Craftsman chevron design with ① bronze waterglass, ② seeded glass, ③ clear bevels, ④ gray artique glass and coming. Artistically authentic in every detail.

Available in:  
American Style Collection™  
Mahogany Collection™  
Rustic Collection™  
Oak Collection™  
Canvas Collection™

1 5 10  
Glass Privacy Rating

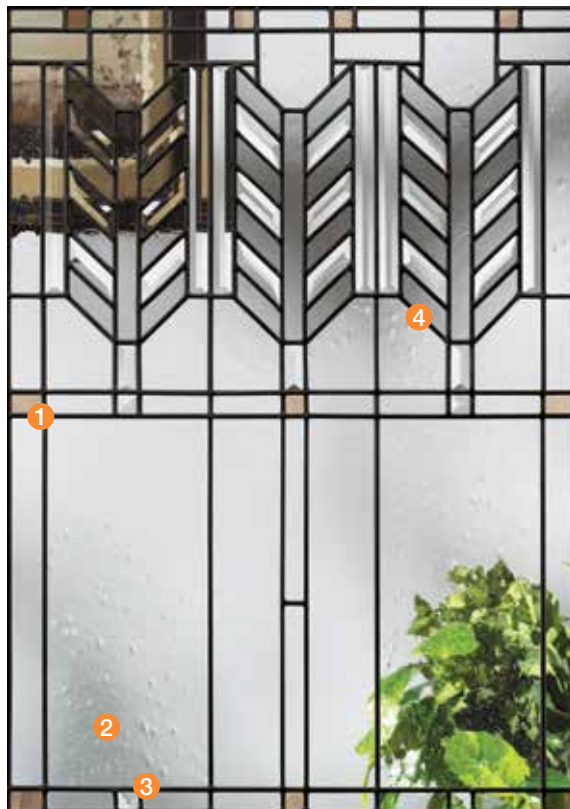

Black Nickel



Brushed Nickel

Note: Glass privacy ratings may be more or less than indicated, based on glass design and size of glass. Glass designs may differ from depiction due to size and hand craftsmanship of glass. See your Therma-Tru seller or visit [www.thermatru.com](http://www.thermatru.com) for details on glass privacy ratings and designs.

## Homeward™

The balanced Mission-style pattern of Homeward invites light to cascade through its distinctive **1** clear bevels, **2** seeded glass and **3** gray artique glass. An ideal complement for a Transitional home design.

Available in:  
 American Style Collection™  
 Mahogany Collection™  
 Rustic Collection™  
 Oak Collection™  
 Canvas Collection.

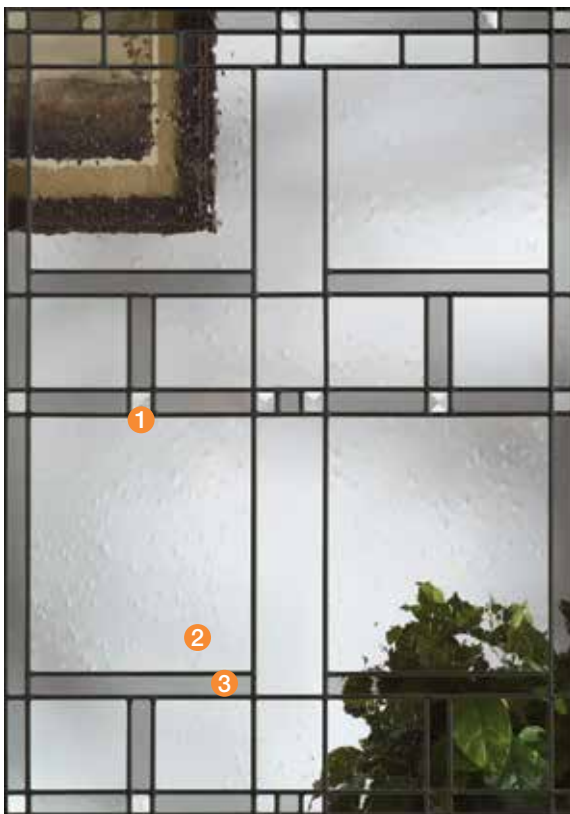

Black Nickel



Brushed Nickel

## Arcadia™

With its timeless petal design, Arcadia combines **1** gray baroque glass, **2** seeded glass, **3** clear curved bevels and coming for a distinctive display that evokes a simpler time.

Available in:  
 Mahogany Collection™  
 Rustic Collection™  
 Oak Collection™  
 Canvas Collection.

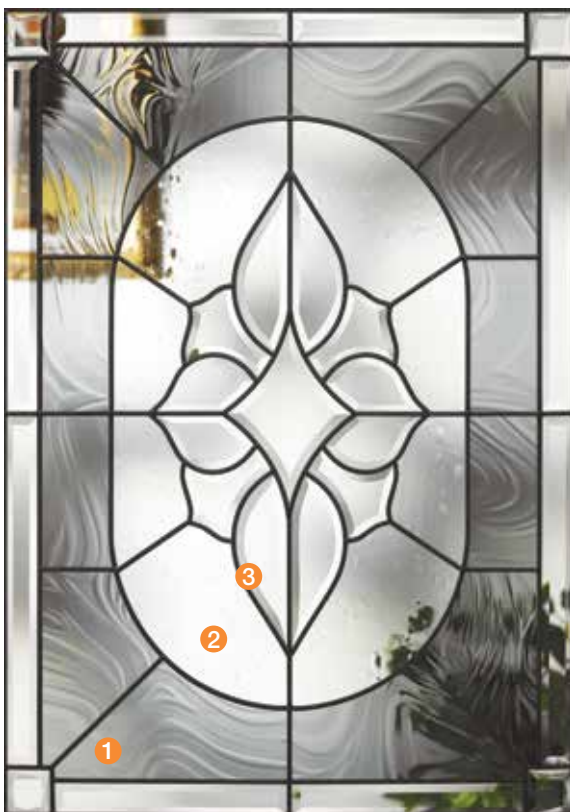

Black Nickel



Brushed Nickel



Brass



## Augustine.

Augustine's swirl leaf design adds that touch of elegance. Made of round wrought iron and ① granite glass for the ultimate in privacy, Augustine pays homage to classic English styling.

Available in:  
 Mahogany Collection™  
 Rustic Collection™  
 Canvas Collection®



Glass Privacy Rating



Wrought Iron

Note: Features a lite frame with an authentic wrought iron look in a black finish. Refer to the image on page 109 to see an example on a home.

## Ashurst™

Ashurst recalls the familiar feel of American-crafted sophistication. ① Clear bevels, ② double waterglass and coming come together to provide modest privacy with a traditional vibe.

Available in:  
 Mahogany Collection™  
 Rustic Collection™  
 Canvas Collection®



Glass Privacy Rating

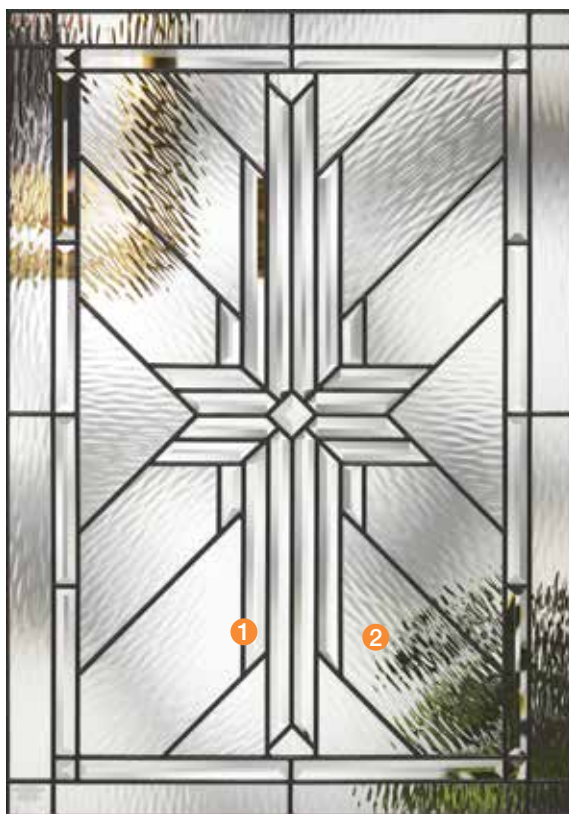

Black Nickel



Brushed Nickel

Note: Glass privacy ratings may be more or less than indicated, based on glass design and size of glass. Glass designs may differ from depiction due to size and hand craftsmanship of glass. See your Therma-Tru seller or visit [www.thermatru.com](http://www.thermatru.com) for details on glass privacy ratings and designs.



## Bella™

As its name suggests, Bella's design is delicate and appealing, bringing together **1** clear bevels, **2** clear baroque glass, **3** rainglass, **4** seeded glass, **5** bronze waterglass and coming.

Available in:  
 Mahogany Collection™  
 Rustic Collection™  
 Oak Collection™  
 Canvas Collection.

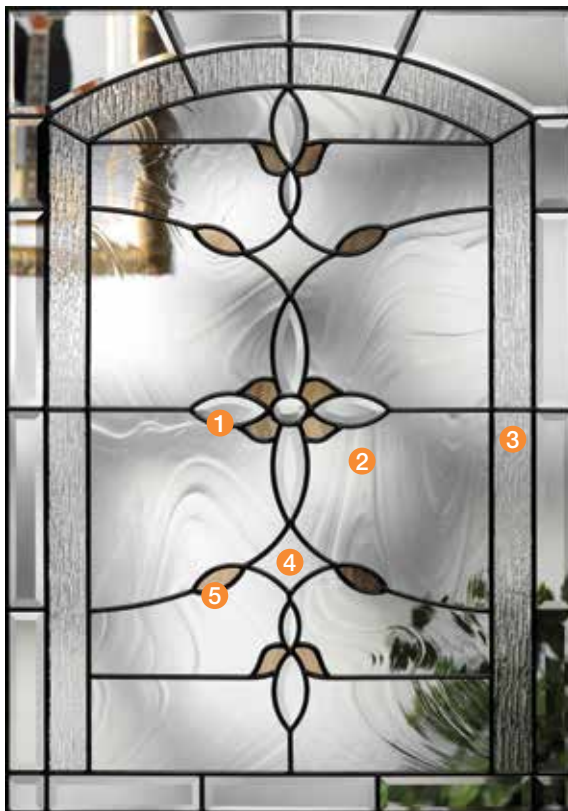

Black Nickel



Brushed Nickel

## Arborwatch®

An eclectic interpretation of the Arts and Crafts movement, Arborwatch combines **1** narrow reed glass, **2** M seedy glass, **3** waterglass and coming in a symmetrical arrangement accented by **4** pale amber glass, **5** amber artique glass and **6** clear bevels.

Available in:  
 American Style Collection™  
 Mahogany Collection™  
 Rustic Collection™  
 Oak Collection™  
 Canvas Collection.



Black Nickel



Brushed Nickel

Note: The use of pale amber and amber artique glass varies based on glass size. Refer to the image on page 49 to see an example on a home.

## Borrassa®

A statement of strength and beauty, Borrassa combines linear and curved wrought iron with **1** hammered glass for the ultimate in privacy. Wrought iron decorative accents add an authentic Old World feel to this stately design.

Available in:  
 Mahogany Collection™  
 Rustic Collection™  
 Canvas Collection®

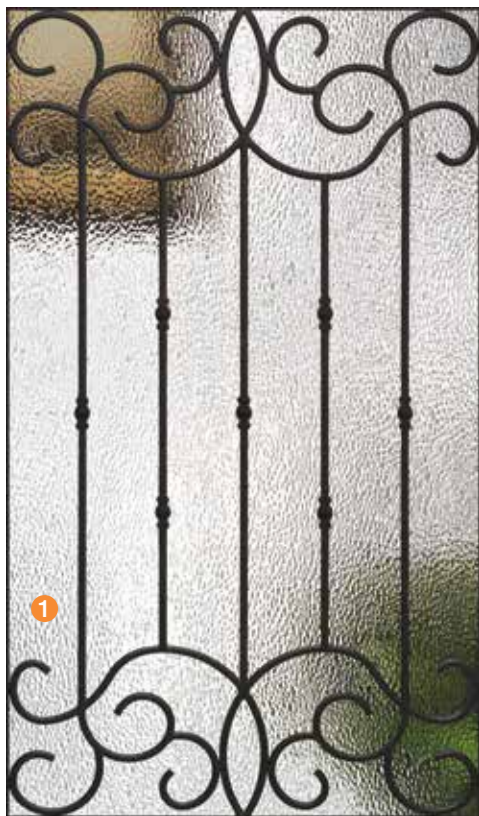

Wrought Iron

Note: Features a lite frame with an authentic wrought iron look in a black finish. Refer to the image on page 109 to see an example on a home.

## Provincial™

A unique diamond-based motif features **1** double waterglass, **2** clear bevels and coming surrounded by a **3** gray baroque glass border. Provincial captivates with stunning clarity.

Available in:  
 Rustic Collection™  
 Oak Collection™  
 Canvas Collection®



Black Nickel



Brushed Nickel



Brass

Note: Glass privacy ratings may be more or less than indicated, based on glass design and size of glass. Glass designs may differ from depiction due to size and hand craftsmanship of glass. See your Therma-Tru seller or visit [www.thermatru.com](http://www.thermatru.com) for details on glass privacy ratings and designs.



## Longford™

The traditional design of Longford integrates a hint of a Celtic knot with ① seeded glass, ② clear bevels, ③ granite glass and coming. A timeless design ideal for entries where modest privacy is desired.

Available in:  
Mahogany Collection™  
Rustic Collection™  
Canvas Collection.

1 8 10  
Glass Privacy Rating

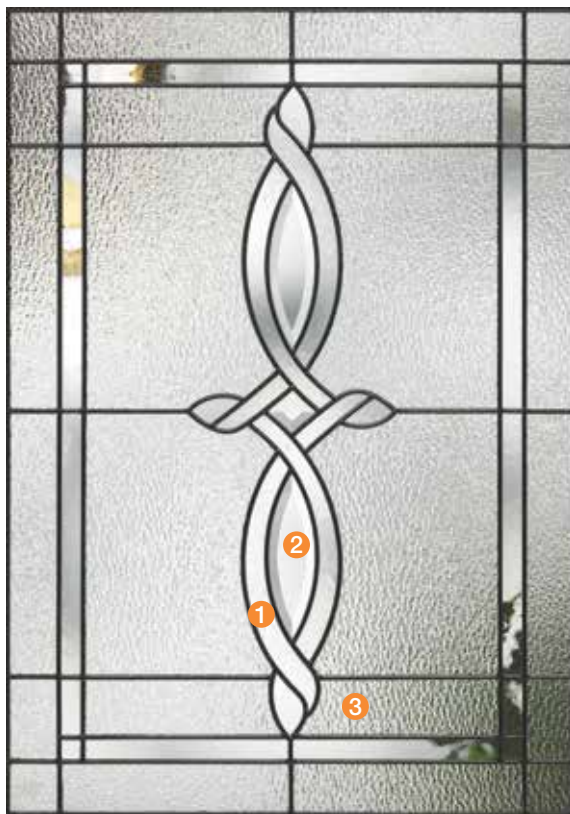

Black Nickel



Brushed Nickel

## Cambridge™

Ornate and enchanting, Cambridge exhibits a traditional 19<sup>th</sup> century-inspired elegance with modest privacy using ① glue chip glass, ② clear curved bevels, ③ double waterglass and coming.

Available in:  
Rustic Collection™  
Oak Collection™  
Canvas Collection.

1 8 10  
Glass Privacy Rating

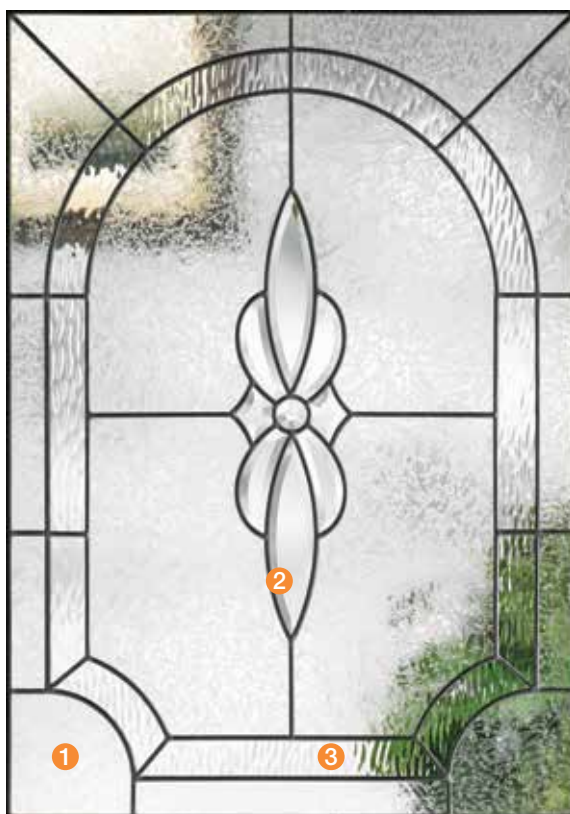

Black Nickel



Brushed Nickel



Brass



## Zaha.

Structured right angles are offset by dynamic curves in this high-energy design. Zaha features ① oceana and ② seedy glass, ③ clear and ④ multifaceted bevels, and coming to create a refreshing and unexpected elegance that appeals to Contemporary home styles.

Available in:  
 Mahogany Collection™  
 Rustic Collection™  
 Canvas Collection®



Black Nickel



Brushed Nickel

## Lucerna.

Named for the beauty of light it reflects, Lucerna glass presents an elegant, updated fleur-de-lis pattern in a spectrum of ① curved, ② diamond and ③ rectangular bevels surrounded by smooth, swirling ④ barn wood and heavily textured ⑤ diamond border glass.

Available in:  
 Mahogany Collection™  
 Rustic Collection™  
 Oak Collection™  
 Canvas Collection®



Black Nickel



Brushed Nickel

Note: Glass privacy ratings may be more or less than indicated, based on glass design and size of glass. Glass designs may differ from depiction due to size and hand craftsmanship of glass. See your Therma-Tru seller or visit [www.thermatru.com](http://www.thermatru.com) for details on glass privacy ratings and designs.

## Privacy & Textured Glass

### Chord Glass

A vertical flowing pattern reminiscent of waves on the water.

Available in:  
 American Style Collection™  
 Mahogany Collection™  
 Rustic Collection™  
 Oak Collection™  
 Canvas Collection®

1

10

Glass Privacy Rating



### Chinchilla Glass

A free-flowing configuration, presenting quiet lines and curves.

Available in:  
 American Style Collection™  
 Mahogany Collection™  
 Rustic Collection™  
 Oak Collection™  
 Canvas Collection®

1

10

Glass Privacy Rating





### Rainglass

An elegantly fashioned glass, featuring ripples of cascading water.

Available in:  
 American Style Collection™  
 Mahogany Collection™  
 Rustic Collection™  
 Oak Collection™  
 Canvas Collection®



### Granite Glass

A coarse grained arrangement with surface detail over the entirety of glass.

Available in:  
 American Style Collection™  
 Mahogany Collection™  
 Rustic Collection™  
 Oak Collection™  
 Canvas Collection®



Note: Glass privacy ratings may be more or less than indicated, based on glass design and size of glass. Glass designs may differ from depiction due to size and hand craftsmanship of glass. See your Therma-Tru seller or visit [www.thermatru.com](http://www.thermatru.com) for details on glass privacy ratings and designs.



## Divided Lites

Enhance the beauty of any home with divided lites for entry and patio doors. Increase curb appeal by coordinating with window grid patterns for a cohesive look that suits the home's architectural details.

### Simulated Divided Lites (SDLs)\*

Wood-grained or smooth SDL bars adhere to the interior and exterior panes of tempered glass and can be stained or painted to complement the door and home.

Look for the (■) icon.



Classic-Craft®  
American Style Collection™



Classic-Craft®  
Canvas Collection®

### Removable Wood Grilles

Removable wood grilles snap on and off the interior pane of tempered glass for easy cleaning. Can be stained or painted to complement the home décor.

Look for the (▶) icon.



\*Not recommended for use behind storm doors or to be painted dark colors, if exposed to direct sunlight.

Top: Classic-Craft Canvas Collection, Low-E Glass with SDLs, Door – CCV940, Sidelites – CCV100SL, Transom – 19220T, Dentil Shelf





## Clavos & Strap Hinges

Add a finishing touch of rustic flavor with decorative hardware in an authentic, hand-forged wrought iron look with a black finish. Includes pyramid and round clavos, as well as strap hinges.



1-1/2"

1-1/4"

1"

1-3/4"

1-1/4"

1"



18"



Top: Classic-Craft Rustic Collection Door – CCR205; Rainglass, Sidelites – CCR3400XRSL; Clavos & Strap Hinges



**4-Block Dentil Shelf**  
Shown on 3'6" x 8'0" door.



**4-Block Dentil Shelf**  
Shown on 3'0" x 8'0" door.

## Dentil Shelves

Complete the look with a dentil shelf for true Craftsman appeal or to complement other architectural elements around the house. Includes 4- and 16-block options.



**Classic-Craft. American Style Collection. 4-Block Dentil Shelf**



**Classic-Craft. American Style Collection. 4-Block Dentil Shelf\***



**Classic-Craft. American Style Collection. 16-Block Dentil Shelf**



**Classic-Craft. Canvas Collection. 4-Block Dentil Shelf**

\*Pairs with 3'6" wide doors.

Top: Classic-Craft American Style Collection, Low-E Glass with SDLs, Door – CCA8230, Sidelites – CCA3500SL, Dentil Shelf





Classic-Craft<sup>®</sup>  
Entry Doors

THERMA TRU<sup>®</sup>  
DOORS



INSPIRE

# Classic-Craft® American Style Collection™

- Vertical Douglas Fir grain.

The simple vertical lines and Shaker-style recessed panels of Classic-Craft American Style premium fiberglass entryways create a timeless look that is perfect for Craftsman-inspired Cottage- and Bungalow-style homes.



# Classic-Craft® American Style Collection™

Features high-definition vertical Douglas Fir grain with Craftsman styling, ideal for homes with an Arts and Crafts flair.



## Architectural Character

- Architecturally correct design – up to 25% wider panels.\*
- Deeper embossments.
- Solid hardwood square edges.
- AccuGrain® technology.
- More than 10% wider glass.\*
- Flush-glazed doors and sidelites.
- Exclusive glass designs.
- Low-E glass standard.

## Heavier Construction

- 20% heavier construction.\*
- Top and bottom composite rails.
- 4- $\frac{1}{8}$ " full-length engineered lumber lockstile for added weight and rigidity.
- Thicker fiberglass skins.

## Available Sizes

- 3'0" and 3'6" wide doors in 6'8" and 8'0" heights.
- 2- $\frac{1}{2}$ " of height trimmability allows flexibility to fit 80"–82- $\frac{1}{2}$ " and 96"–98- $\frac{1}{2}$ " rough openings.

## Finish Options

Classic-Craft American Style entryways can be stained or painted any color.

- Tru-Defense. Warranty Rider eligible when properly assembled and installed with all Therma-Tru specified system components, in accordance with the Rider.

## Flush-Glazed Fiberglass Door Replacement Rider

Provides protection in case of accidental glass breakage during residential and multi-family construction or installation. Therma-Tru will replace the flush-glazed fiberglass door and glass.

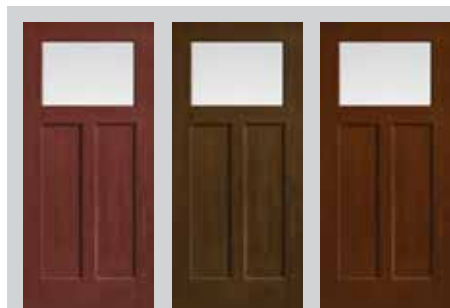

## SAME-DAY STAIN

See the difference stain can make. Kit available in seven finish colors on pages 264–265.



\*Comparison of Classic-Craft to other standard fiberglass doors with similar styles. Visit [www.thermatru.com](http://www.thermatru.com) for details.

Note: Finish colors may vary from an actual application due to fluctuations in finishing or printing. Glass privacy ratings may be more or less than indicated, based on glass design and size of glass. Glass designs may differ from depiction due to size and hand craftsmanship of glass. See your Therma-Tru seller or visit [www.thermatru.com](http://www.thermatru.com) for more, including details on height trimmability, limited warranties and exclusions, Riders and ENERGY STAR qualified products.

Bottom: Classic-Craft American Style Collection, Chord Glass with SDLs, Door – CCA8240XC

Right Page: Classic-Craft American Style Collection, Arborwatch Glass, Door – CC9100, Sidelites – CCA9100SL, Dentil Shelf

# Decorative Glass Designs



**Villager™** Page 48  
Glass Privacy Rating: **5**



**Homeward™** Page 48  
Glass Privacy Rating: **4**



**Arborwatch®** Page 49  
Glass Privacy Rating: **6**

Also Available:

## Privacy & Textured Glass

Page 50

## Low-E Glass

Page 51

Glass Privacy Rating Scale

**1 2 3 4 5 6 7 8 9 10**

Clear

Opaque

## Caming Options

- ◆ Black Nickel Caming (1D)
- Brushed Nickel Caming (1C)

■ Simulated divided lites (SDLs) available to create authentic Craftsman glass configurations.





# Villager™



**CCA212**  
  
 3'0" x 6'8"

**CCA8212**  
  
 3'0" x 8'0"

**CCA222**  
  
 3'0" x 6'8"

**CCA8222**  
  
 3'0" x 8'0"

**CCA232**  
  
 3'0" x 6'8"

**CCA8232**  
  
 3'0" x 8'0"

**CCA3402SL**  
  
 12" x 6'8"  
 14" x 6'8"

**CCA3502SL**  
  
 12" x 8'0"  
 14" x 8'0"

**CCA212SL**  
  
 12" x 6'8"  
 14" x 6'8"

**VGRT**  
  
 3'0" door + (2) 12" sidelites  
 3'0" door + (2) 14" sidelites  
 Continuous Sill Systems Only

**VG30T**  
  
 3'0" Door Only

# Homeward™



**CCA211**  
  
 3'0" x 6'8"

**CCA8211**  
  
 3'0" x 8'0"

**CCA87112**  
  
 3'6" x 8'0"

**CCA221**  
  
 3'0" x 6'8"

**CCA8221**  
  
 3'0" x 8'0"

**CCA87122**  
  
 3'6" x 8'0"

**CCA231**  
  
 3'0" x 6'8"

**CCA8231**  
  
 3'0" x 8'0"

**CCA87132**  
  
 3'6" x 8'0"



**CCA3401SL**  
  
 12" x 6'8"  
 14" x 6'8"

**CCA3501SL**  
  
 12" x 8'0"  
 14" x 8'0"

**CCA211SL**  
  
 12" x 6'8"  
 14" x 6'8"

**HWRT**  
  
 3'0" door + (2) 12" sidelites  
 3'0" door + (2) 14" sidelites  
 Continuous Sill Systems Only

**HW30T**  
  
 3'0" Door Only



\*Pairs with 3'6" wide doors.

Note: See page 273 for important product details that may help with your purchase decision.

Bottom: Classic-Craft American Style Collection, Homeward Glass, Door – CCA211, Sidelites – CCA3401SL, Transom – HWRT, Dentil Shelf  
 Right Page: Classic-Craft American Style Collection, Arborwatch Glass with SDLs, Door – CCA9300, Sidelites – CCA9100SL

# Arborwatch.



CCA9100  
 ▲ ◆ ■ ■ ■ ■  
 3'0" x 6'8"



CCA87111  
 ▲ ◆ ■ ■ ■ ■  
 3'6" x 8'0"



CCA9200  
 ▲ ◆ ■ ■ ■ ■  
 3'0" x 6'8"



CCA87121  
 ▲ ◆ ■ ■ ■ ■  
 3'6" x 8'0"



CCA9300  
 ▲ ◆ ■ ■ ■ ■  
 3'0" x 6'8"

CCA89300  
 ▲ ◆ ■ ■ ■ ■  
 3'0" x 8'0"



CCA87131  
 ▲ ◆ ■ ■ ■ ■  
 3'6" x 8'0"



CCA1423SL  
 ▲ ◆ ■ ■ ■ ■  
 12" x 6'8"  
 14" x 6'8"



CCA81423SL  
 ▲ ◆ ■ ■ ■ ■  
 12" x 8'0"  
 14" x 8'0"



CCA9100SL  
 ▲ ◆ ■ ■ ■ ■  
 12" x 6'8"  
 14" x 6'8"



ABRT  
 ▲ ◆ ■ ■ ■ ■  
 3'0" door + (2) 12" sidelites  
 3'0" door + (2) 14" sidelites  
 Continuous Sill Systems Only



AB30T  
 ▲ ◆ ■ ■ ■ ■  
 3'0" Door Only



## Key

- ▲ Flush-Glazed Glass (FG)
- ◆ Black Nickel Caming (1D)
- Brushed Nickel Caming (1C)
- Simulated Divided Lites (SDL)

## Optional Dentil Shelves

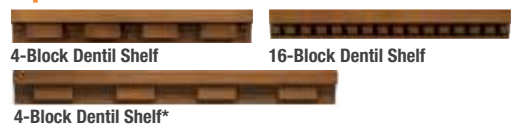



# Privacy & Textured Glass



CCA210\_\_  
3'0" x 6'8"



CCA8210\_\_  
3'0" x 8'0"



CCA220\_\_  
3'0" x 6'8"



CCA8220\_\_  
3'0" x 8'0"



CCA87200\_\*  
3'6" x 8'0"



CCA230\_\_  
3'0" x 6'8"



CCA8230\_\_  
3'0" x 8'0"



CCA87300\_\*  
3'6" x 8'0"



CCA240\_\_  
3'0" x 6'8"



CCA8240\_\_  
3'0" x 8'0"



CCA87400\_\*  
3'6" x 8'0"



CCA260\_\_  
3'0" x 6'8"



CCA8260\_\_  
3'0" x 8'0"



CCA87600\_\*  
3'6" x 8'0"



CCA3400\_\_SL  
12" x 6'8"  
14" x 6'8"



CCA3500\_\_SL  
12" x 8'0"  
14" x 8'0"



CCA3450\_\_SL  
12" x 6'8"  
14" x 6'8"



CCA3560\_\_SL  
12" x 8'0"  
14" x 8'0"



CCA210\_\_SL  
12" x 6'8"  
14" x 6'8"



CCA220\_\_SL  
12" x 6'8"  
14" x 6'8"

## Privacy & Textured Glass Options

Add the code to the blank in the style number for the desired door and glass combination. For details on glass options, see pages 39–40.

XC = Chord Glass

XR = Rainglass

XJ = Chinchilla Glass

XN = Granite Glass

\*Available in Rainglass only.

\*\*Pairs with 3'6" wide doors.

Note: See page 273 for important product details that may help with your purchase decision.

# Low-E Glass



CCA210  
 🔥🌟  
 3'0" x 6'8"

CCA8210  
 🔥🌟  
 3'0" x 8'0"



CCA87100  
 🔥🌟  
 3'6" x 8'0"



CCA220  
 🔥🌟🔱  
 3'0" x 6'8"

CCA8220  
 🔥🌟🔱  
 3'0" x 8'0"



CCA87200  
 🔥🌟🔱  
 3'6" x 8'0"



CCA230  
 🔥🌟🔱  
 3'0" x 6'8"

CCA8230  
 🔥🌟🔱  
 3'0" x 8'0"



CCA87300  
 🔥🌟🔱  
 3'6" x 8'0"



CCA240  
 🔥🌟🔱  
 3'0" x 6'8"

CCA8240  
 🔥🌟🔱  
 3'0" x 8'0"



CCA87400  
 🔥🌟🔱  
 3'6" x 8'0"



CCA260  
 🔥🌟🔱  
 3'0" x 6'8"

CCA8260  
 🔥🌟🔱  
 3'0" x 8'0"



CCA87600  
 🔥🌟🔱  
 3'6" x 8'0"



CCA3400SL  
 🔥🌟  
 12" x 6'8"  
 14" x 6'8"



CCA3500SL  
 🔥🌟  
 12" x 8'0"  
 14" x 8'0"

CCA3450SL  
 🔥🌟🔱  
 12" x 6'8"  
 14" x 6'8"

CCA3560SL  
 🔥🌟🔱  
 12" x 8'0"  
 14" x 8'0"



CCA210SL  
 🔥🌟  
 12" x 6'8"  
 14" x 6'8"



CCA220SL  
 🔥🌟🔱  
 12" x 6'8"  
 14" x 6'8"



19220T  
 🌟  
 3'0" door + (2) 12" sidelites  
 3'0" door + (2) 14" sidelites  
 Continuous / Boxed Sill Systems



19200T  
 🌟  
 3'0" Door Only

## Key

- 🔥 Flush-Glazed Glass (FG)
- 🌟 Low-E Glass (LE)
- 🔱 Simulated Divided Lites (SDL)

## Optional Dentil Shelves

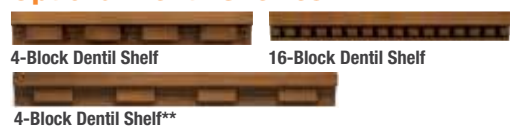





Classic-Craft<sup>®</sup>  
Entry Doors

THERMA TRU  
DOORS



D R E A M



# Classic-Craft<sup>®</sup>

## Mahogany Collection<sup>™</sup>

- Rich, warm Mahogany wood tones.

Especially suited for European, Victorian and Colonial home styles, Classic-Craft Mahogany premium fiberglass entryways are a sophisticated, elegant option for homeowners looking to make a statement by creating dramatic, grand entrances.



# Classic-Craft® Mahogany Collection™

Offers rich, warm wood tones in authentic Honduran Mahogany, especially suited for European, Victorian and Colonial homes.



## SAME-DAY STAIN

See the difference stain can make. Kit available in seven finish colors on pages 264–265.

### Architectural Character

- Architecturally correct design – up to 25% wider panels.\*
- Deeper embossments.
- Solid hardwood square edges.
- AccuGrain® technology.
- More than 10% wider glass.\*
- Flush-glazed sidelites.
- Fiberglass lite frames.
- Exclusive glass designs.
- Low-E glass standard.

### Heavier Construction



- 20% heavier construction.\*
- Top and bottom composite rails.
- 4- $\frac{1}{8}$ " full-length engineered lumber lockstile for added weight and rigidity.
- Thicker fiberglass skins.

### Available Sizes

- 3'0" wide doors in 6'8" and 8'0" heights.
- 2- $\frac{1}{2}$ " of height trimmability allows flexibility to fit 80"–82- $\frac{1}{2}$ " and 96"–98- $\frac{1}{2}$ " rough openings.

### Finish Options

Classic-Craft Mahogany entryways can be stained or painted any color.

- 
**WBDR / HVHZ Options:** Look for this icon to find door styles that can be configured for WBDR or HVHZ.\*\*
- 
**Fire-rated options** available on solid-panel doors. See pages 227–231.
- 
**Tru-Defense.** Warranty Rider eligible when properly assembled and installed with all Therma-Tru specified system components, in accordance with the Rider.



\*Comparison of Classic-Craft to other standard fiberglass doors with similar styles. Visit [www.thermatru.com](http://www.thermatru.com) for details.

\*\*Please verify that there is a Therma-Tru product approval for the configuration before buying.  
 Note: Finish colors may vary from an actual application due to fluctuations in finishing or printing. Glass privacy ratings may be more or less than indicated, based on glass design and size of glass. Glass designs may differ from depiction due to size and hand craftsmanship of glass. See your Therma-Tru seller or visit [www.thermatru.com](http://www.thermatru.com) for more, including details on height trimmability, limited warranties and exclusions, Tru-Defense Rider, ENERGY STAR qualified products and product approvals.

Bottom: Classic-Craft Mahogany Collection, Zaha Glass, Door – CCM1851, Sidelites – CCM1851SL  
 Right Page: Classic-Craft Mahogany Collection, Lucerna Glass, Door – CCM702, Sidelites – CCM3412SL, Transom – LCET

# Decorative Glass Designs



**Villager™** Page 56  
Glass Privacy Rating: **5**



**Homeward™** Page 56  
Glass Privacy Rating: **4**



**Arcadia™** Page 57  
Glass Privacy Rating: **5**



**Augustine®** Page 57  
Glass Privacy Rating: **10**



**Ashurst™** Page 58  
Glass Privacy Rating: **8**



**Bella™** Page 58  
Glass Privacy Rating: **6**



**Arborwatch.** Page 59  
Glass Privacy Rating: **6**



**Borrassa.** Page 59  
Glass Privacy Rating: **10**



**Longford™** Page 60  
Glass Privacy Rating: **8**



**Zaha.** Page 60  
Glass Privacy Rating: **3**



**Lucerna®** Page 61  
Glass Privacy Rating: **7**

Also Available:

**Privacy & Textured Glass** Page 61

**Low-E Glass** Page 62

### Caming Options

- ◆ Black Nickel Caming (1D)
- Brushed Nickel Caming (1C)
- ◆ Brass Caming (1A)
- ✕ Wrought Iron (1W)

Glass Privacy Rating Scale

**1 2 3 4 5 6 7 8 9 10**

Clear

Opaque





# Villager™



CCM9812  
◆  
3'0" x 6'8"



CCM9816  
◆  
3'0" x 6'8"



CCM89818  
◆  
3'0" x 8'0"



CCM9811  
◆  
3'0" x 6'8"



CCM9812SL  
◆  
12" x 6'8"  
14" x 6'8"

CCM89812SL  
◆  
12" x 8'0"  
14" x 8'0"



VGRT  
◆  
3'0" door + (2) 12" sidelites  
3'0" door + (2) 14" sidelites  
Continuous Sill Systems Only



VG30T  
◆  
3'0" Door Only

# Homeward™



CCM9925  
◆  
3'0" x 6'8"



CCM9923  
◆  
3'0" x 6'8"



CCM89922  
◆  
3'0" x 8'0"



CCM9926  
◆  
3'0" x 6'8"



CCM9925SL  
◆  
12" x 6'8"  
14" x 6'8"

CCM89925SL  
◆  
12" x 8'0"  
14" x 8'0"



HWRT  
◆  
3'0" door + (2) 12" sidelites  
3'0" door + (2) 14" sidelites  
Continuous Sill Systems Only



HW30T  
◆  
3'0" Door Only



Note: See page 273 for important product details that may help with your purchase decision.

Bottom: Classic-Craft Mahogany Collection, Arcadia Glass, Door – CCM209, Sidelites – CCM3309SL, Transom – CC620T

# Arcadia™



CCM109  
◆ ◆ ◆  
3'0" x 6'8"



CCM209  
◆ ◆ ◆  
3'0" x 6'8"



CCM894  
◆ ◆ ◆  
3'0" x 8'0"



CCM309  
◆ ◆ ◆  
3'0" x 6'8"



CCM409  
◆ ◆ ◆  
3'0" x 6'8"



CCM509  
◆ ◆ ◆  
3'0" x 6'8"



CCM609  
◆ ◆ ◆  
3'0" x 6'8"



CCM709  
◆ ◆ ◆  
3'0" x 6'8"



CCM809  
◆ ◆ ◆  
3'0" x 6'8"



CCM3409SL  
◆ ◆ ◆ ◆  
12" x 6'8"  
14" x 6'8"



CCM8003SL  
◆ ◆ ◆ ◆  
12" x 8'0"  
14" x 8'0"



CCM3309SL  
◆ ◆ ◆ ◆  
10" x 6'8"  
12" x 6'8"  
14" x 6'8"



CCM3509SL  
◆ ◆ ◆ ◆  
12" x 6'8"  
14" x 6'8"



ARHRT  
◆ ◆ ◆  
3'0" door + (2) 12" sidelites  
3'0" door + (2) 14" sidelites  
Continuous / Boxed Sill Systems



CC620T  
◆ ◆ ◆  
3'0" door + (2) 12" sidelites  
3'0" door + (2) 14" sidelites  
Continuous Sill Systems Only



CC060T  
◆ ◆ ◆  
3'0" door + (2) 12" sidelites  
3'0" door + (2) 14" sidelites  
Continuous Sill Systems Only



CC600T  
◆ ◆ ◆  
3'0" Door Only

# Augustine®

Note: Product images show exterior side of door.



CCM30027  
X  
3'0" x 6'8"



CCM1485  
X  
3'0" x 6'8"



CCM805027  
X  
3'0" x 8'0"



CCM1495  
X  
3'0" x 6'8"



CCM3400XNSL  
◆  
12" x 6'8"  
14" x 6'8"



CCM8000XNSL  
◆  
12" x 8'0"  
14" x 8'0"

Note: Coordinating sidelites feature granite glass without wrought iron.

## Key

- ◆ Flush-Glazed Glass (FG)
- ◆ Black Nickel Caming (1D)
- ◆ Brushed Nickel Caming (1C)
- ◆ Brass Caming (1A)
- ✗ Wrought Iron (1W)



# Ashurst<sup>™</sup>



CCM105  
◆ ■■  
3'0" x 6'8"



CCM205  
◆ ■■  
3'0" x 6'8"



CCM893  
◆ ■■  
3'0" x 8'0"



CCM305  
◆ ■■  
3'0" x 6'8"



CCM405  
◆ ■■  
3'0" x 6'8"



CCM505  
◆ ■■  
3'0" x 6'8"



CCM605  
◆ ■■  
3'0" x 6'8"



CCM705  
◆ ■■  
3'0" x 6'8"



CCM805  
◆ ■■  
3'0" x 6'8"



CCM3405SL  
▲ ◆ ◆ ■■  
12" x 6'8"  
14" x 6'8"

CCM8002SL  
▲ ◆ ◆ ■■  
12" x 8'0"  
14" x 8'0"



CCM3305SL  
▲ ◆ ◆ ■■  
10" x 6'8"  
12" x 6'8"  
14" x 6'8"



CCM3505SL  
▲ ◆ ◆ ■■  
12" x 6'8"  
14" x 6'8"



ASHRT  
◆ ■■  
3'0" door + (2) 12" sidelites  
3'0" door + (2) 14" sidelites  
Continuous / Boxed Sill Systems



ASRT  
◆ ■■  
3'0" door + (2) 12" sidelites  
3'0" door + (2) 14" sidelites  
Continuous Sill Systems Only



ASET  
◆ ■■  
3'0" door + (2) 12" sidelites  
3'0" door + (2) 14" sidelites  
Continuous Sill Systems Only



AS30T  
◆ ■■  
3'0" Door Only

# Bella<sup>™</sup>



CCM110B  
◆ ■■  
3'0" x 6'8"



CCM210B  
◆ ■■  
3'0" x 6'8"



CCM895B  
◆ ■■  
3'0" x 8'0"



CCM310B  
◆ ■■  
3'0" x 6'8"



CCM610B  
◆ ■■  
3'0" x 6'8"



CCM710B  
◆ ■■  
3'0" x 6'8"



CCM810B  
◆ ■■  
3'0" x 6'8"

**CCM3410BSL**  
 ◆ ◆ ◆ ◆  
 12" x 6'8"  
 14" x 6'8"

**CCM8004BSL**  
 ◆ ◆ ◆ ◆  
 12" x 8'0"  
 14" x 8'0"

**CCM3310BSL**  
 ◆ ◆ ◆ ◆  
 10" x 6'8"  
 12" x 6'8"  
 14" x 6'8"

**CCM3510BSL**  
 ◆ ◆ ◆ ◆  
 12" x 6'8"  
 14" x 6'8"

**BEBHRT**  
 ◆ ◆ ◆ ◆  
 3'0" door + (2) 12" sidelites  
 3'0" door + (2) 14" sidelites  
 Continuous / Boxed Sill Systems

**BEET-B**  
 ◆ ◆ ◆ ◆  
 3'0" door + (2) 12" sidelites  
 3'0" door + (2) 14" sidelites  
 Continuous Sill Systems Only

**BERT-B**  
 ◆ ◆ ◆ ◆  
 3'0" door + (2) 12" sidelites  
 3'0" door + (2) 14" sidelites  
 Continuous Sill Systems Only

## Arborwatch<sup>®</sup>

**CCM1423**  
 ◆ ◆ ◆ ◆  
 3'0" x 6'8"

**CCM1419**  
 ◆ ◆ ◆ ◆  
 3'0" x 6'8"

**CCM81418**  
 ◆ ◆ ◆ ◆  
 3'0" x 8'0"

**CCM1424**  
 ◆ ◆ ◆ ◆  
 3'0" x 6'8"

**CCM1423SL**  
 ◆ ◆ ◆ ◆  
 12" x 6'8"  
 14" x 6'8"

**CCM81423SL**  
 ◆ ◆ ◆ ◆  
 12" x 8'0"  
 14" x 8'0"

**AB30T**  
 ◆ ◆ ◆ ◆  
 3'0" Door Only

**ABRT**  
 ◆ ◆ ◆ ◆  
 3'0" door + (2) 12" sidelites  
 3'0" door + (2) 14" sidelites  
 Continuous Sill Systems Only

## Borrassa<sup>®</sup>

Note: Product images show exterior side of door.

**CCM1528**  
 X  
 3'0" x 6'8"

**CCM1475**  
 X  
 3'0" x 6'8"

**CCM81519**  
 X  
 3'0" x 8'0"

**CCM1465**  
 X  
 3'0" x 6'8"

**CCM3400XHSL**  
 ◆  
 12" x 6'8"  
 14" x 6'8"

**CCM8000XHSL**  
 ◆  
 12" x 8'0"  
 14" x 8'0"

Note: Coordinating sidelites feature hammered glass without wrought iron.

### Key

- ◆ Flush-Glazed Glass (FG)
- ◆ Black Nickel Caming (1D)
- ◆ Wrought Iron (1W)
- ◆ Brass Caming (1A)
- ◆ X
- ◆ Brushed Nickel Caming (1C)



# Longford<sup>™</sup>



**CCM103**  
◆ ◆  
3'0" x 6'8"



**CCM203**  
◆ ◆  
3'0" x 6'8"



**CCM892**  
◆ ◆  
3'0" x 8'0"



**CCM303**  
◆ ◆  
3'0" x 6'8"



**CCM403**  
◆ ◆  
3'0" x 6'8"



**CCM503**  
◆ ◆  
3'0" x 6'8"



**CCM603**  
◆ ◆  
3'0" x 6'8"



**CCM703**  
◆ ◆  
3'0" x 6'8"



**CCM803**  
◆ ◆  
3'0" x 6'8"



**CCM3403SL**  
◆ ◆ ◆  
12" x 6'8"  
14" x 6'8"



**CCM8001SL**  
◆ ◆ ◆  
12" x 8'0"  
14" x 8'0"



**CCM3303SL**  
◆ ◆ ◆  
10" x 6'8"  
12" x 6'8"  
14" x 6'8"



**CCM3503SL**  
◆ ◆ ◆  
12" x 6'8"  
14" x 6'8"



**LFHRT**  
◆ ◆  
3'0" door + (2) 12" sidelites  
3'0" door + (2) 14" sidelites  
Continuous / Boxed Sill Systems



**LFRT**  
◆ ◆  
3'0" door + (2) 12" sidelites  
3'0" door + (2) 14" sidelites  
Continuous Sill Systems Only



**LFET**  
◆ ◆  
3'0" door + (2) 12" sidelites  
3'0" door + (2) 14" sidelites  
Continuous Sill Systems Only



**LF30T**  
◆ ◆  
3'0" Door Only

# Zaha<sup>®</sup>

Note: Product images show exterior side of door.



**CCM1851**  
◆ ◆  
3'0" x 6'8"



**CCM1844**  
◆ ◆  
3'0" x 6'8"



**CCM81843**  
◆ ◆  
3'0" x 8'0"



**CCM1842**  
◆ ◆  
3'0" x 6'8"



**CCM1851SL**  
◆ ◆ ◆  
12" x 6'8"  
14" x 6'8"



**CCM81851SL**  
◆ ◆ ◆  
12" x 8'0"  
14" x 8'0"



**CCM1843SL**  
◆ ◆ ◆  
10" x 6'8"  
12" x 6'8"  
14" x 6'8"



**ZHHRT**  
◆ ◆  
3'0" door + (2) 12" sidelites  
3'0" door + (2) 14" sidelites  
Continuous / Boxed Sill Systems



**ZHRT**  
◆ ◆  
3'0" door + (2) 12" sidelites  
3'0" door + (2) 14" sidelites  
Continuous Sill Systems Only

# Lucerna<sup>®</sup>



CCM10022  
◆ ◆  
3'0" x 6'8"



CCM204  
◆ ◆  
3'0" x 6'8"



CCM898  
◆ ◆  
3'0" x 8'0"



CCM302  
◆ ◆  
3'0" x 6'8"



CCM612  
◆ ◆  
3'0" x 6'8"



CCM702  
◆ ◆  
3'0" x 6'8"



CCM822  
◆ ◆  
3'0" x 6'8"



CCM3412SL  
◆ ◆ ◆  
12" x 6'8"  
14" x 6'8"



CCM8102SL  
◆ ◆ ◆  
12" x 8'0"  
14" x 8'0"



CCM3302SL  
◆ ◆ ◆  
10" x 6'8"  
12" x 6'8"  
14" x 6'8"

CCM3502SL  
◆ ◆ ◆  
12" x 6'8"  
14" x 6'8"



LCRT  
◆ ◆  
3'0" door + (2) 12" sidelites  
3'0" door + (2) 14" sidelites  
Continuous / Boxed Sill Systems



LCRT  
◆ ◆  
3'0" door + (2) 12" sidelites  
3'0" door + (2) 14" sidelites  
Continuous Sill Systems Only



LCET  
◆ ◆  
3'0" door + (2) 12" sidelites  
3'0" door + (2) 14" sidelites  
Continuous Sill Systems Only



LC30T  
◆ ◆  
3'0" Door Only

# Privacy & Textured Glass



CCM100  
3'0" x 6'8"



CCM200  
3'0" x 6'8"



CCM891  
3'0" x 8'0"



CCM300  
3'0" x 6'8"



CCM3400\_\_SL  
◆  
12" x 6'8"  
14" x 6'8"



CCM8000\_\_SL  
◆  
12" x 8'0"  
14" x 8'0"

## Privacy & Textured Glass Options

Add the code to the blank in the style number for the desired door and glass combination. For details on glass options, see pages 39–40.

XC = Chord Glass  
XJ = Chinchilla Glass

XR = Rainglass  
XN = Granite Glass

## Key

- ◆ Flush-Glazed Glass (FG)
- ◆ Black Nickel Caming (1D)
- ◆ Brushed Nickel Caming (1C)



# Low-E Glass



|                                   |                                   |                                   |                                   |                                   |                                   |                                   |                                   |
|-----------------------------------|-----------------------------------|-----------------------------------|-----------------------------------|-----------------------------------|-----------------------------------|-----------------------------------|-----------------------------------|
| <b>CCM100</b><br>*<br>3'0" x 6'8" | <b>CCM200</b><br>*<br>3'0" x 6'8" | <b>CCM891</b><br>*<br>3'0" x 8'0" | <b>CCM300</b><br>*<br>3'0" x 6'8" | <b>CCM400</b><br>*<br>3'0" x 6'8" | <b>CCM500</b><br>*<br>3'0" x 6'8" | <b>CCM600</b><br>*<br>3'0" x 6'8" | <b>CCM700</b><br>*<br>3'0" x 6'8" |
|-----------------------------------|-----------------------------------|-----------------------------------|-----------------------------------|-----------------------------------|-----------------------------------|-----------------------------------|-----------------------------------|



|                                   |  |  |  |  |   |   |
|-----------------------------------|--|--|--|--|---|---|
| <b>CCM800</b><br>*<br>3'0" x 6'8" | <b>CCM3400SL</b><br>▲*<br>12" x 6'8"<br>14" x 6'8" | <b>CCM8000SL</b><br>▲*<br>12" x 8'0"<br>14" x 8'0" | <b>CCM3300SL</b><br>▲*<br>10" x 6'8"<br>12" x 6'8"<br>14" x 6'8" | <b>CCM3500SL</b><br>▲*<br>12" x 6'8"<br>14" x 6'8" | <b>DLHRT</b><br>*<br>3'0" door + (2) 12" sidelites<br>3'0" door + (2) 14" sidelites<br>Continuous / Boxed Sill Systems  | <b>19220T</b><br>*<br>3'0" door + (2) 12" sidelites<br>3'0" door + (2) 14" sidelites<br>Continuous / Boxed Sill Systems |
|                                   |  |  |  |  | <b>19020T</b><br>*<br>3'0" door + (2) 12" sidelites<br>3'0" door + (2) 14" sidelites<br>Continuous / Boxed Sill Systems | <b>19200T</b><br>*<br>3'0" Door Only  |

# Solid Panel



|                                   |                                  |                                   |                              |
|-----------------------------------|----------------------------------|-----------------------------------|------------------------------|
| <b>CCM890</b><br>6<br>3'0" x 8'0" | <b>CCM60</b><br>6<br>3'0" x 6'8" | <b>CCM701</b><br>6<br>3'0" x 6'8" | <b>CCM801</b><br>3'0" x 6'8" |
|-----------------------------------|----------------------------------|-----------------------------------|------------------------------|

## Key

- ▲ Flush-Glazed Glass (FG)
- \* Low-E Glass (LE)
- 6 WBD / HVHZ Options







Classic-Craft<sup>®</sup>  
Entry Doors

THERMA TRU<sup>®</sup>  
DOORS

BEAUTY

# Classic-Craft®

## Rustic

## Collection™

- Casually elegant wood graining.

Designed to complement American Southwest and European-inspired home styles, Classic-Craft Rustic premium fiberglass entryways feature casually elegant wood graining that can be coordinated with decorative glass and accessories to create enchanting entrances.



# Classic-Craft® Rustic Collection™

Seamlessly blends Southwest and European styling with rustic wood grains to evoke Old World charm.

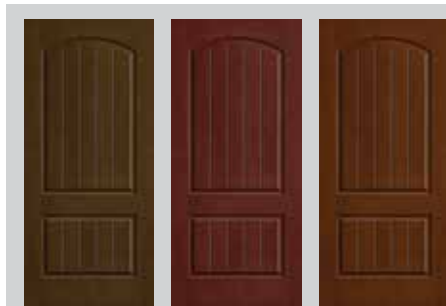

## SAME-DAY STAIN

See the difference stain can make. Kit available in seven finish colors on pages 264–265.

### Architectural Character

- Architecturally correct design – up to 25% wider panels.\*
- Deeper embossments.
- Solid hardwood square edges.
- AccuGrain® technology.
- More than 10% wider glass.\*
- Flush-glazed sidelites.
- Fiberglass lite frames.
- Exclusive glass designs.
- Low-E glass standard.

### Heavier Construction

- 20% heavier construction.\*
- Top and bottom composite rails.
- 4-1/8" full-length engineered lumber lockstile for added weight and rigidity.
- Thicker fiberglass skins.

### Available Sizes

- 3'0" and 3'6" wide doors in 6'8" and 8'0" heights.
- 2-1/2" of height trimmability allows flexibility to fit 80"–82-1/2" and 96"–98-1/2" rough openings.

### Finish Options

Classic-Craft Rustic entryways can be stained or painted any color.

- ⑥ WBDR / HVHZ Options: Look for this icon to find door styles that can be configured for WBDR or HVHZ.\*\*
- 🔥 Fire-rated options available on solid-panel doors. See pages 227–231.
- ⊕ Tru-Defense. Warranty Rider eligible when properly assembled and installed with all Therma-Tru specified system components, in accordance with the Rider.



\*Comparison of Classic-Craft to other standard fiberglass doors with similar styles. Visit [www.thermatru.com](http://www.thermatru.com) for details.

\*\*Please verify that there is a Therma-Tru product approval for the configuration before buying.

Note: Finish colors may vary from an actual application due to fluctuations in finishing or printing. Glass privacy ratings may be more or less than indicated, based on glass design and size of glass. Glass designs may differ from depiction due to size and hand craftsmanship of glass. See your Therma-Tru seller or visit [www.thermatru.com](http://www.thermatru.com) for more, including details on height trimmability, limited warranties and exclusions, Tru-Defense Rider, ENERGY STAR qualified products and product approvals.

Bottom: Classic-Craft Rustic Collection, Ashurst Glass, Door – CCR804035

# Decorative Glass Designs



**Villager™** Page 68  
Glass Privacy Rating: **5**



**Homeward™** Page 69  
Glass Privacy Rating: **4**



**Arcadia™** Page 69  
Glass Privacy Rating: **5**



**Augustine®** Page 70  
Glass Privacy Rating: **10**



**Ashurst™** Page 71  
Glass Privacy Rating: **8**



**Bella™** Page 72  
Glass Privacy Rating: **6**



**Arborwatch™** Page 72  
Glass Privacy Rating: **6**



**Borrassa™** Page 73  
Glass Privacy Rating: **10**



**Provincial™** Page 74  
Glass Privacy Rating: **6**



**Longford™** Page 75  
Glass Privacy Rating: **8**



**Cambridge™** Page 75  
Glass Privacy Rating: **8**



**Zaha®** Page 76  
Glass Privacy Rating: **3**



**Lucerna®** Page 76  
Glass Privacy Rating: **7**

Also Available:

**Privacy & Textured Glass**  
Page 77

**Low-E Glass**  
Page 78

Glass Privacy Rating Scale



**Caming Options**

- ◆ Black Nickel Caming (1D)
- Brushed Nickel Caming (1C)
- ◆ Brass Caming (1A)
- ✕ Wrought Iron (1W)

# Panel Embossments



2-Panel Square Top – WS



2-Panel Soft Arch  
4-Panel Round Top  
Arched 2-Panel Soft Arch  
Radiused 4-Panel Round Top  
2-Panel Round Top  
Radiused 2-Panel Round Top



2-Panel Plank Soft Arch  
Arched 2-Panel Plank Soft Arch  
1-Panel Plank Soft Arch  
2-Panel Plank Round Top  
Radiused 2-Panel Plank Round Top



Arched Full Plank  
Full Plank  
Radiused Full Plank



# Villager™



**VGRT**  
◆ ◆  
3'0" door + (2) 12" sidelites  
3'0" door + (2) 14" sidelites  
Continuous Sill Systems Only



**VG30T**  
◆ ◆ ◆  
3'0" Door Only



Note: See page 273 for important product details that may help with your purchase decision.  
Top: Classic-Craft Rustic Collection, Villager Glass, Door – CCR9822

# Homeward™



# Arcadia™



## Key

- ◆ Flush-Glazed Glass (FG)
- ◆ Black Nickel Caming (1D)
- Brushed Nickel Caming (1C)
- ◆ Brass Caming (1A)
- ✕ Wrought Iron (1W)



# Augustine

Note: Product images show exterior side of door.



CCR30027  
X  
3'0" x 6'8"



CCR04027  
X  
3'0" x 6'8"



CCR804027  
X  
3'0" x 8'0"  
3'6" x 8'0"



CCR04037  
X  
3'0" x 6'8"



CCR804037  
X  
3'0" x 8'0"  
3'6" x 8'0"



CCR04037A  
X  
3'0" x 6'8"



CCR804037A  
X  
3'0" x 8'0"  
3'6" x 8'0"



CCR20527  
X  
3'0" x 6'8"



CCR820527  
X  
3'0" x 8'0"  
3'6" x 8'0"



CCR20537  
X  
3'0" x 6'8"



CCR820537A  
X  
3'0" x 8'0"  
3'6" x 8'0"



CCR20027  
X  
3'0" x 6'8"



CCR820027  
X  
3'0" x 8'0"



CCR822227  
X  
3'0" x 8'0"  
3'6" x 8'0"



CCR20037  
X  
3'0" x 6'8"



CCR820037  
X  
3'0" x 8'0"



CCR20037A  
X  
3'0" x 6'8"



CCR820037A  
X  
3'0" x 8'0"



CCR3400XNSL  
▲  
12" x 6'8"  
14" x 6'8"



CCR8000XNSL  
▲  
12" x 8'0"  
14" x 8'0"

Note: Coordinating sidelites feature granite glass without wrought iron.





CCR30025  
◆ ■  
3'0" x 6'8"

CCR04025  
◆ ■  
3'0" x 6'8"

CCR804025  
◆ ■  
3'0" x 8'0"

CCR804035  
◆ ■  
3'0" x 8'0"

CCR804035A  
◆ ■  
3'0" x 8'0"

CCR20525  
◆ ■  
3'0" x 6'8"

CCR820525  
◆ ■  
3'0" x 8'0"

CCR820535  
◆ ■  
3'0" x 8'0"



CCR820535A  
◆ ■  
3'0" x 8'0"

CCR20025  
◆ ■  
3'0" x 6'8"

CCR820025  
◆ ■  
3'0" x 8'0"

CCR822225  
◆ ■  
3'0" x 8'0"

CCR820035  
◆ ■  
3'0" x 8'0"

CCR820035A  
◆ ■  
3'0" x 8'0"

CCR3405SL  
◆ ■  
12" x 6'8"  
14" x 6'8"

CCR8001SL  
◆ ■  
12" x 8'0"  
14" x 8'0"



ASHRT ◆ ■  
3'0" door + (2) 12" sidelites  
3'0" door + (2) 14" sidelites  
Continuous / Boxed Sill Systems



ASET ◆ ■  
3'0" door + (2) 12" sidelites  
3'0" door + (2) 14" sidelites  
Continuous Sill Systems Only



ASRT ◆ ■  
3'0" door + (2) 12" sidelites  
3'0" door + (2) 14" sidelites  
Continuous Sill Systems Only



AS30T ◆ ■  
3'0" Door Only

## Key

- ◆ Flush-Glazed Glass (FG)
- ◆ Black Nickel Caming (1D)
- Brushed Nickel Caming (1C)
- ✗ Wrought Iron (1W)



# Bella™



**BEBHRT**  
 ◆ ◆  
 3'0" door + (2) 12" sidelites  
 3'0" door + (2) 14" sidelites  
 Continuous / Boxed Sill Systems



**BEET-B**  
 ◆ ◆  
 3'0" door + (2) 12" sidelites  
 3'0" door + (2) 14" sidelites  
 Continuous Sill Systems Only



**BERT-B**  
 ◆ ◆  
 3'0" door + (2) 12" sidelites  
 3'0" door + (2) 14" sidelites  
 Continuous Sill Systems Only

# Arborwatch®



**ABRT**  
 ◆ ◆  
 3'0" door + (2) 12" sidelites  
 3'0" door + (2) 14" sidelites  
 Continuous Sill Systems Only



**AB30T**  
 ◆ ◆  
 3'0" Door Only

# Borrassa®

Note: Product images show exterior side of door.



CCR1528  
X  
3'0" x 6'8"

CCR1518  
X  
3'0" x 6'8"

CCR81518  
X  
3'0" x 8'0"  
3'6" x 8'0"

CCR1514  
X  
3'0" x 6'8"

CCR81514  
X  
3'0" x 8'0"  
3'6" x 8'0"

CCR1514A  
X  
3'0" x 6'8"

CCR81514A  
X  
3'0" x 8'0"  
3'6" x 8'0"

CCR1516  
X  
3'0" x 6'8"

CCR81516  
X  
3'0" x 8'0"  
3'6" x 8'0"

CCR1512  
X  
3'0" x 6'8"

CCR81512  
X  
3'0" x 8'0"  
3'6" x 8'0"



CCR1512A  
X  
3'0" x 6'8"

CCR81512A  
X  
3'0" x 8'0"  
3'6" x 8'0"

CCR1515  
X  
3'0" x 6'8"

CCR81515  
X  
3'0" x 8'0"

CCR822215  
X  
3'0" x 8'0"  
3'6" x 8'0"

CCR1511  
X  
3'0" x 6'8"

CCR81511  
X  
3'0" x 8'0"

CCR1511A  
X  
3'0" x 6'8"

CCR81511A  
X  
3'0" x 8'0"

CCR3400XHSL  
▲  
12" x 6'8"  
14" x 6'8"

CCR8000XHSL  
▲  
12" x 8'0"  
14" x 8'0"

Note:  
Coordinating  
sidelites  
feature  
hammered  
glass without  
wrought iron.



## Key

- ▲ Flush-Glazed Glass (FG)
- ◆ Black Nickel Caming (1D)
- Brushed Nickel Caming (1C)
- X Wrought Iron (1W)



# Provincial<sup>™</sup>



**CCR30028**  
 ◆ ◆ ◆  
 3'0" x 6'8"



**CCR04028**  
 ◆ ◆ ◆ ◆  
 3'0" x 6'8"



**CCR804028**  
 ◆ ◆ ◆ ◆  
 3'0" x 8'0"



**CCR20528**  
 ◆ ◆ ◆ ◆  
 3'0" x 6'8"



**CCR820528**  
 ◆ ◆ ◆ ◆  
 3'0" x 8'0"



**CCR20028**  
 ◆ ◆ ◆ ◆  
 3'0" x 6'8"



**CCR820028**  
 ◆ ◆ ◆ ◆  
 3'0" x 8'0"



**CCR822228**  
 ◆ ◆ ◆ ◆  
 3'0" x 8'0"



**CCR3408SL**  
 ◆ ◆ ◆ ◆ ◆  
 12" x 6'8"  
 14" x 6'8"



**CCR8008SL**  
 ◆ ◆ ◆ ◆ ◆  
 12" x 8'0"  
 14" x 8'0"



**PRHRT**  
 ◆ ◆ ◆  
 3'0" door + (2) 12" sidelites  
 3'0" door + (2) 14" sidelites  
 Continuous / Boxed Sill Systems



**CC040T**  
 ◆ ◆ ◆ ◆  
 3'0" door + (2) 12" sidelites  
 3'0" door + (2) 14" sidelites  
 Continuous Sill Systems Only



**CC420T**  
 ◆ ◆ ◆ ◆  
 3'0" door + (2) 12" sidelites  
 3'0" door + (2) 14" sidelites  
 Continuous Sill Systems Only



**CC400T**  
 ◆ ◆ ◆ ◆  
 3'0" Door Only

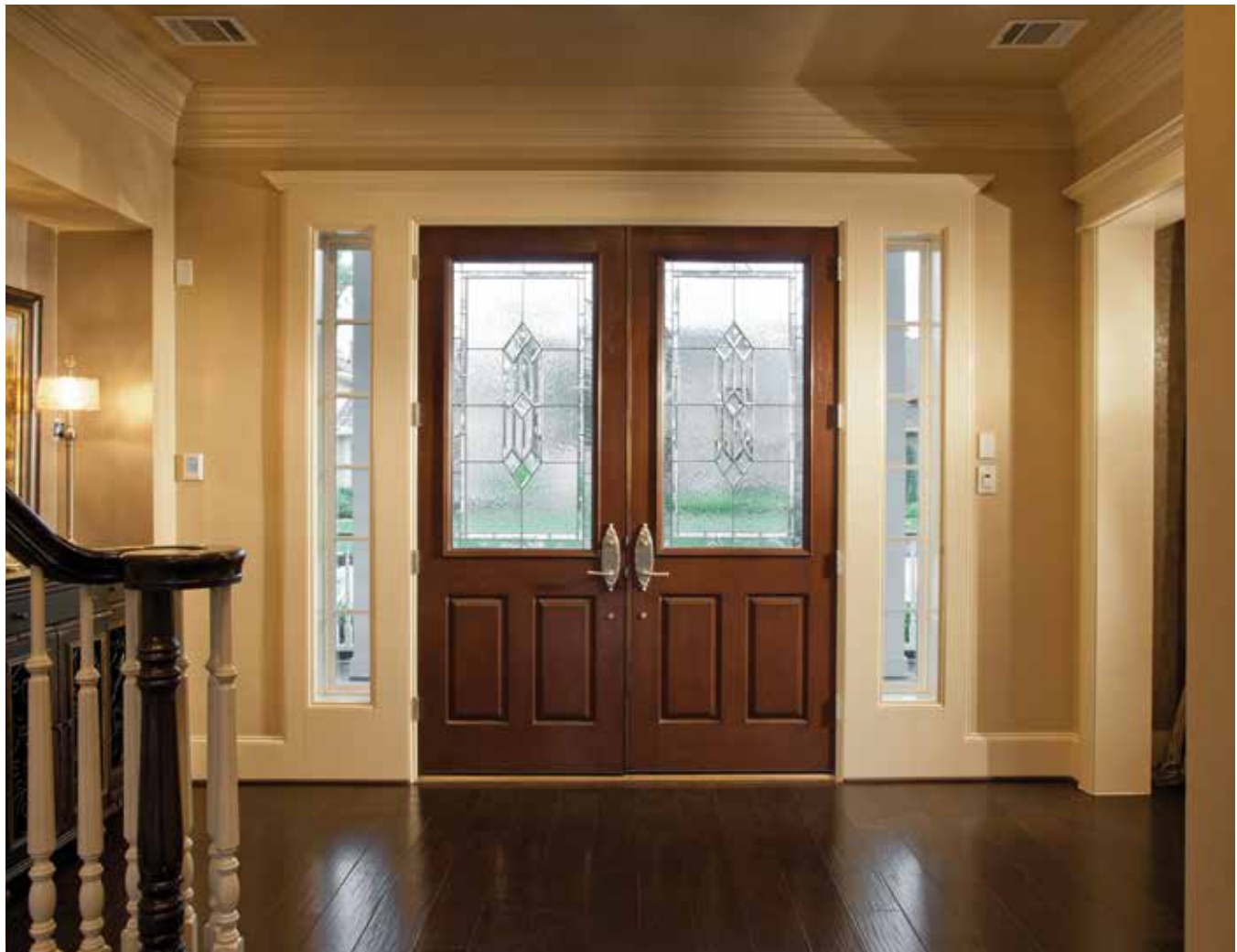

Note: See page 273 for important product details that may help with your purchase decision.  
 Bottom: Classic-Craft Rustic Collection, Provincial Glass, Doors – CCR804028

# Longford™



CCR30023  
◆ ■ ■  
3'0" x 6'8"

CCR04023  
◆ ■ ■  
3'0" x 6'8"

CCR804023  
◆ ■ ■  
3'0" x 8'0"

CCR20523  
◆ ■ ■  
3'0" x 6'8"

CCR820523  
◆ ■ ■  
3'0" x 8'0"

CCR20023  
◆ ■ ■  
3'0" x 6'8"

CCR820023  
◆ ■ ■  
3'0" x 8'0"

CCR822223  
◆ ■ ■  
3'0" x 8'0"

CCR3407SL  
▲ ◆ ■ ■  
12" x 6'8"  
14" x 6'8"

CCR8007SL  
▲ ◆ ■ ■  
12" x 8'0"  
14" x 8'0"



LFHRT  
◆ ■ ■  
3'0" door + (2) 12" sidelites  
3'0" door + (2) 14" sidelites  
Continuous / Boxed Sill Systems



LFET  
◆ ■ ■  
3'0" door + (2) 12" sidelites  
3'0" door + (2) 14" sidelites  
Continuous Sill Systems Only



LFRT  
◆ ■ ■  
3'0" door + (2) 12" sidelites  
3'0" door + (2) 14" sidelites  
Continuous Sill Systems Only



LF30T  
◆ ■ ■  
3'0" Door Only

# Cambridge™



CCR30026  
◆ ■ ■ ■  
3'0" x 6'8"

CCR04026  
◆ ■ ■ ■  
3'0" x 6'8"

CCR804026  
◆ ■ ■ ■  
3'0" x 8'0"

CCR20526  
◆ ■ ■ ■  
3'0" x 6'8"

CCR820526  
◆ ■ ■ ■  
3'0" x 8'0"

CCR20026  
◆ ■ ■ ■  
3'0" x 6'8"

CCR820026  
◆ ■ ■ ■  
3'0" x 8'0"

CCR822226  
◆ ■ ■ ■  
3'0" x 8'0"

CCR3406SL  
▲ ◆ ■ ■ ■  
12" x 6'8"  
14" x 6'8"

CCR8006SL  
▲ ◆ ■ ■ ■  
12" x 8'0"  
14" x 8'0"



CBHRT  
◆ ■ ■ ■  
3'0" door + (2) 12" sidelites  
3'0" door + (2) 14" sidelites  
Continuous / Boxed Sill Systems



CC090T  
◆ ■ ■ ■  
3'0" door + (2) 12" sidelites  
3'0" door + (2) 14" sidelites  
Continuous Sill Systems Only



CC920T  
◆ ■ ■ ■  
3'0" door + (2) 12" sidelites  
3'0" door + (2) 14" sidelites  
Continuous Sill Systems Only



CC900T  
◆ ■ ■ ■  
3'0" Door Only

## Key

- ▲ Flush-Glazed Glass (FG)
- ◆ Black Nickel Caming (1D)
- Brushed Nickel Caming (1C)
- ❖ Brass Caming (1A)

# Zaha<sup>®</sup>

Note: Product images show exterior side of door.



|                                      |                                      |                                       |                                       |  |                                      |                                       |                                       |
|--------------------------------------|--------------------------------------|---------------------------------------|---------------------------------------|--|--------------------------------------|---------------------------------------|---------------------------------------|
| <b>CCR1851</b><br>◆ ◆<br>3'0" x 6'8" | <b>CCR1841</b><br>◆ ◆<br>3'0" x 6'8" | <b>CCR81841</b><br>◆ ◆<br>3'0" x 8'0" | <b>CCR81847</b><br>◆ ◆<br>3'0" x 8'0" | <b>CCR81847A</b><br>◆ ◆<br>3'0" x 8'0" | <b>CCR1839</b><br>◆ ◆<br>3'0" x 6'8" | <b>CCR81839</b><br>◆ ◆<br>3'0" x 8'0" | <b>CCR81846</b><br>◆ ◆<br>3'0" x 8'0" |
|--------------------------------------|--------------------------------------|---------------------------------------|---------------------------------------|--|--------------------------------------|---------------------------------------|---------------------------------------|



|  |                                      |                                       |  |                                       |  |   |  |
|--|--------------------------------------|---------------------------------------|--|---------------------------------------|--|---|--|
| <b>CCR81846A</b><br>◆ ◆<br>3'0" x 8'0" | <b>CCR1838</b><br>◆ ◆<br>3'0" x 6'8" | <b>CCR81838</b><br>◆ ◆<br>3'0" x 8'0" | <b>CCR822238</b><br>◆ ◆<br>3'0" x 8'0" | <b>CCR81845</b><br>◆ ◆<br>3'0" x 8'0" | <b>CCR81845A</b><br>◆ ◆<br>3'0" x 8'0" | <b>CCR1851SL</b><br>◆ ◆ ◆<br>12" x 6'8"<br>14" x 6'8" | <b>CCR81851SL</b><br>◆ ◆ ◆<br>12" x 8'0"<br>14" x 8'0" |
|--|--------------------------------------|---------------------------------------|--|---------------------------------------|--|---|--|



**ZHHRT**  
◆ ◆  
3'0" door + (2) 12" sidelites  
3'0" door + (2) 14" sidelites  
Continuous / Boxed Sill Systems



**ZHRT**  
◆ ◆  
3'0" door + (2) 12" sidelites  
3'0" door + (2) 14" sidelites  
Continuous Sill Systems Only

# Lucerna<sup>®</sup>



|                                       |                                       |   |                                       |   |                                       |  |   |  |
|---------------------------------------|---------------------------------------|---|---------------------------------------|---|---------------------------------------|--|---|--|
| <b>CCR10022</b><br>◆ ◆<br>3'0" x 6'8" | <b>CCR04022</b><br>◆ ◆<br>3'0" x 6'8" | <b>CCR804022</b><br>◆ ◆<br>3'0" x 8'0"<br>3'6" x 8'0" | <b>CCR20522</b><br>◆ ◆<br>3'0" x 6'8" | <b>CCR820522</b><br>◆ ◆<br>3'0" x 8'0"<br>3'6" x 8'0" | <b>CCR20022</b><br>◆ ◆<br>3'0" x 6'8" | <b>CCR820022</b><br>◆ ◆<br>3'0" x 8'0" | <b>CCR822222</b><br>◆ ◆<br>3'0" x 8'0"<br>3'6" x 8'0" | <b>CCR820532</b><br>◆ ◆<br>3'0" x 8'0" |
|---------------------------------------|---------------------------------------|---|---------------------------------------|---|---------------------------------------|--|---|--|

\*Available in Rainglass only.  
Note: See page 273 for important product details that may help with your purchase decision.





CCR820532A  
 ◆ ■ ■  
 3'0" x 8'0"



CCR820032  
 ◆ ■ ■  
 3'0" x 8'0"



CCR820032A  
 ◆ ■ ■  
 3'0" x 8'0"



CCR804032  
 ◆ ■ ■  
 3'0" x 8'0"



CCR804032A  
 ◆ ■ ■  
 3'0" x 8'0"



CCR3412SL  
 ◆ ◆ ■ ■  
 12" x 6'8"  
 14" x 6'8"



CCR8102SL  
 ◆ ◆ ■ ■  
 12" x 8'0"  
 14" x 8'0"



LCHRT  
 ◆ ■ ■  
 3'0" door + (2) 12" sidelites  
 3'0" door + (2) 14" sidelites  
 Continuous / Boxed Sill Systems



LCET  
 ◆ ■ ■  
 3'0" door + (2) 12" sidelites  
 3'0" door + (2) 14" sidelites  
 Continuous Sill Systems Only

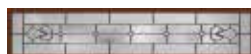

LCRT  
 ◆ ■ ■  
 3'0" door + (2) 12" sidelites  
 3'0" door + (2) 14" sidelites  
 Continuous Sill Systems Only



LC30T  
 ◆ ■ ■  
 3'0" Door Only

## Privacy & Textured Glass



CCR30020  
 3'0" x 6'8"



CCR04020  
 3'0" x 6'8"



CCR804020  
 3'0" x 8'0"  
 3'6" x 8'0"\*



CCR20520  
 3'0" x 6'8"



CCR820520  
 3'0" x 8'0"  
 3'6" x 8'0"\*



CCR20020  
 3'0" x 6'8"



CCR820020  
 3'0" x 8'0"



CCR822220  
 3'0" x 8'0"  
 3'6" x 8'0"\*



CCR804030  
 3'0" x 8'0"

Privacy & Textured Glass *Continues on next page.*

### Privacy & Textured Glass Options

Add the code to the blank in the style number for the desired door and glass combination. For details on glass options, see pages 39-40.

XC = Chord Glass  
 XJ = Chinchilla Glass

XR = Rainglass  
 XN = Granite Glass

### Key

- ◆ Flush-Glazed Glass (FG)
- ◆ Black Nickel Caming (1D)
- ■ Brushed Nickel Caming (1C)

## Privacy & Textured Glass *Continued*



CCR820530  
3'0" x 8'0"



CCR820030  
3'0" x 8'0"



CCR804030A  
3'0" x 8'0"



CCR820530A  
3'0" x 8'0"



CCR820030A  
3'0" x 8'0"



CCR3400\_SL  
▲  
12" x 6'8"  
14" x 6'8"



CCR8000\_SL  
▲  
12" x 8'0"  
14" x 8'0"

## Low-E Glass



CCR30020  
★  
3'0" x 6'8"



CCR04020  
★  
3'0" x 6'8"



CCR804020  
★  
3'0" x 8'0"  
3'6" x 8'0"



CCR804030  
★  
3'0" x 8'0"



CCR804030A  
★  
3'0" x 8'0"



CCR20520  
★  
3'0" x 6'8"



CCR820520  
★  
3'0" x 8'0"  
3'6" x 8'0"



CCR820530  
★  
3'0" x 8'0"



CCR820530A  
★  
3'0" x 8'0"



CCR20020  
★  
3'0" x 6'8"



CCR820020  
★  
3'0" x 8'0"



CCR822220  
★  
3'0" x 8'0"  
3'6" x 8'0"



CCR820030  
★  
3'0" x 8'0"



CCR820030A  
★  
3'0" x 8'0"

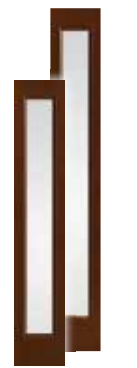

CCR3400SL  
▲★  
12" x 6'8"  
14" x 6'8"



CCR8000SL  
▲★  
12" x 8'0"  
14" x 8'0"



DLHRT  
★  
3'0" door + (2) 12" sidelites  
3'0" door + (2) 14" sidelites  
Continuous / Boxed Sill Systems



19020T  
★  
3'0" door + (2) 12" sidelites  
3'0" door + (2) 14" sidelites  
Continuous Sill Systems Only



19220T  
★  
3'0" door + (2) 12" sidelites  
3'0" door + (2) 14" sidelites  
Continuous Sill Systems Only



19200T  
★  
3'0" Door Only

### Privacy & Textured Glass Options

Add the code to the blank in the style number for the desired door and glass combination. For details on glass options, see pages 39–40.

XC = Chord Glass  
XJ = Chinchilla Glass

XR = Rainglass  
XN = Granite Glass

# Solid Panel



CCR205  
3'0" x 6'8"  
CCR8205  
3'0" x 8'0"  
3'6" x 8'0"



CCR205A  
3'0" x 6'8"  
CCR8205A  
3'0" x 8'0"  
3'6" x 8'0"



CCR8225  
3'0" x 8'0"  
3'6" x 8'0"



CCR8225R  
3'0" x 8'0"  
3'6" x 8'0"



CCR8005  
3'0" x 8'0"



CCR8005A  
3'0" x 8'0"



CCR040  
3'0" x 6'8"  
CCR8040  
3'0" x 8'0"  
3'6" x 8'0"



CCR040R  
3'0" x 6'8"  
CCR8040R  
3'0" x 8'0"  
3'6" x 8'0"



CCR8222  
3'0" x 8'0"  
3'6" x 8'0"



CCR200  
3'0" x 6'8"  
CCR8200  
3'0" x 8'0"



CCR200A  
3'0" x 6'8"  
CCR8200A  
3'0" x 8'0"



CCR8220  
3'0" x 8'0"



CCR8220R  
3'0" x 8'0"



CCR100  
3'0" x 6'8"  
3'6" x 6'8"  
CCR8100  
3'0" x 8'0"  
3'6" x 8'0"



CCR100A  
3'0" x 6'8"  
3'6" x 6'8"  
CCR8100A  
3'0" x 8'0"  
3'6" x 8'0"



CCR100R  
3'0" x 6'8"  
3'6" x 6'8"  
CCR8100R  
3'0" x 8'0"  
3'6" x 8'0"

## Key

-  Flush-Glazed Glass (FG)
-  Low-E Glass (LE)
-  WBDR / HVHZ Options





Classic-Craft<sup>®</sup>  
Entry Doors

THERMA TRU<sup>®</sup>  
DOORS

STRIKING



# Classic-Craft®

## Oak

### Collection™

- Warm wood graining.

With warm wood graining, Classic-Craft Oak premium fiberglass entryways are designed as the perfect complement to homes with Traditional styling.

# Classic-Craft® Oak Collection™

Features warm wood grains with the look of classic Oak, suitable for homes with Traditional styling.



## SAME-DAY STAIN

See the difference stain can make. Kit available in seven finish colors on pages 264–265.

### Architectural Character

- Architecturally correct design – up to 25% wider panels.\*
- Deeper embossments.
- Solid hardwood square edges.
- AccuGrain® technology.
- More than 10% wider glass.\*
- Flush-glazed sidelites.
- Fiberglass lite frames.
- Exclusive glass designs.
- Low-E glass standard.

### Heavier Construction



- 20% heavier construction.\*
- Top and bottom composite rails.
- 4- $\frac{1}{8}$ " full-length engineered lumber lockstile for added weight and rigidity.
- Thicker fiberglass skins.

### Available Sizes

- 2'8", 3'0" and 3'6" wide doors in 6'8" and 8'0" heights.
- 2- $\frac{1}{2}$ " of height trimmability allows flexibility to fit 80"–82- $\frac{1}{2}$ " and 96"–98- $\frac{1}{2}$ " rough openings.

### Finish Options

Classic-Craft Oak entryways can be stained or painted any color.

- 
**WBDR / HVHZ Options:** Look for this icon to find door styles that can be configured for WBDR or HVHZ.\*\*
- 
**Fire-rated options** available on solid-panel doors. See pages 227–231.
- 
**Tru-Defense® Warranty Rider** eligible when properly assembled and installed with all Therma-Tru specified system components, in accordance with the Rider.



\*Comparison of Classic-Craft to other standard fiberglass doors with similar styles. Visit [www.thermatru.com](http://www.thermatru.com) for details.

\*\*Please verify that there is a Therma-Tru product approval for the configuration before buying.

Note: Finish colors may vary from an actual application due to fluctuations in finishing or printing. Glass privacy ratings may be more or less than indicated, based on glass design and size of glass. Glass designs may differ from depiction due to size and hand craftsmanship of glass. See your Therma-Tru seller or visit [www.thermatru.com](http://www.thermatru.com) for more, including details on height trimmability, limited warranties and exclusions, Tru-Defense Rider, ENERGY STAR qualified products and product approvals.

Bottom: Classic-Craft Oak Collection, Lucerna Glass, Door – CC822  
Right Page: Classic-Craft Oak Collection, Provincial Glass, Door – CC97, Sidelites – CC2040SL, Transom – CC420T



# Decorative Glass Designs



**Villager™** Page 84  
Glass Privacy Rating: **5**



**Homeward™** Page 84  
Glass Privacy Rating: **4**



**Arcadia™** Page 84  
Glass Privacy Rating: **5**



**Bella™** Page 85  
Glass Privacy Rating: **6**



**Arborwatch.** Page 86  
Glass Privacy Rating: **6**



**Provincial™** Page 87  
Glass Privacy Rating: **6**



**Cambridge™** Page 87  
Glass Privacy Rating: **8**



**Lucerna™** Page 88  
Glass Privacy Rating: **7**

Also Available:

**Privacy & Textured Glass**  
Page 89

**Low-E Glass**  
Page 90

Glass Privacy Rating Scale

**1 2 3 4 5 6 7 8 9 10**  
Clear Opaque

**Caming Options**

- ◆ Black Nickel Caming (1D)
- Brushed Nickel Caming (1C)
- ◆ Brass Caming (1A)

▶ Removable wood grilles available to create authentic Colonial configurations.



# Villager™



CC9812  
◆ ◆  
3'0" x 6'8"

CC9818  
◆ ◆ ◆  
3'0" x 6'8"

CC89818  
◆ ◆ ◆  
3'0" x 8'0"

CC89815  
◆ ◆ ◆  
3'0" x 8'0"

CC9811  
◆ ◆ ◆  
3'0" x 6'8"

CC9812SL  
◆ ◆ ◆ ◆  
12" x 6'8"  
14" x 6'8"

CC89812SL  
◆ ◆ ◆ ◆  
12" x 8'0"  
14" x 8'0"



VGRT  
◆ ◆ ◆  
3'0" door + (2) 12" sidelites  
3'0" door + (2) 14" sidelites  
Continuous Sill Systems Only



VG30T  
◆ ◆ ◆  
3'0" Door Only

# Homeward™



CC9925  
◆ ◆ ◆  
3'0" x 6'8"

CC9922  
◆ ◆ ◆  
3'0" x 6'8"

CC89922  
◆ ◆ ◆ ◆  
3'0" x 8'0"

CC89924  
◆ ◆ ◆ ◆  
3'0" x 8'0"

CC9926  
◆ ◆ ◆ ◆  
3'0" x 6'8"

CC9925SL  
◆ ◆ ◆ ◆ ◆  
12" x 6'8"  
14" x 6'8"

CC89925SL  
◆ ◆ ◆ ◆ ◆  
12" x 8'0"  
14" x 8'0"



HWRT  
◆ ◆ ◆ ◆  
3'0" door + (2) 12" sidelites  
3'0" door + (2) 14" sidelites  
Continuous Sill Systems Only



HW30T  
◆ ◆ ◆ ◆  
3'0" Door Only

# Arcadia™



CC109  
◆ ◆ ◆ ◆  
3'0" x 6'8"

CC99  
◆ ◆ ◆ ◆ ◆  
3'0" x 6'8"

CC899  
◆ ◆ ◆ ◆ ◆  
3'0" x 8'0"

CC839  
◆ ◆ ◆ ◆ ◆  
3'0" x 8'0"

CC45  
◆ ◆ ◆ ◆ ◆  
2'8" x 6'8"  
3'0" x 6'8"

CC79  
◆ ◆ ◆ ◆ ◆  
3'0" x 6'8"

CC19  
◆ ◆ ◆ ◆ ◆  
3'0" x 6'8"

CC2060SL  
◆ ◆ ◆ ◆ ◆ ◆  
12" x 6'8"  
14" x 6'8"

CC8009SL  
◆ ◆ ◆ ◆ ◆ ◆  
12" x 8'0"  
14" x 8'0"





**CC2279SL**  
 ▲ ◆ ■ ❖  
 12" x 6'8"  
 14" x 6'8"



**CC2160SL**  
 ▲ ◆ ■ ❖  
 12" x 6'8"  
 14" x 6'8"



**CC1019SL**  
 ▲ ◆ ■ ❖  
 12" x 6'8"  
 14" x 6'8"



**ARHRT**  
 ◆ ■ ❖  
 3'0" door + (2) 12" sidelites  
 3'0" door + (2) 14" sidelites  
 Continuous / Boxed Sill Systems



**CC060T**  
 ◆ ■ ❖  
 3'0" door + (2) 12" sidelites  
 3'0" door + (2) 14" sidelites  
 Continuous Sill Systems Only



**CC620T**  
 ◆ ■ ❖  
 3'0" door + (2) 12" sidelites  
 3'0" door + (2) 14" sidelites  
 Continuous Sill Systems Only



**CC600T**  
 ◆ ■ ❖  
 3'0" Door Only

## Bella™



**CC111B**  
 ◆ ■  
 3'0" x 6'8"



**CC114B**  
 ◆ ■  
 3'0" x 6'8"

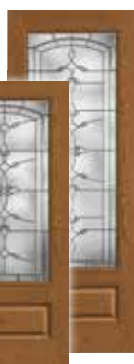

**CC901B**  
 ◆ ■  
 3'0" x 8'0"



**CC900B**  
 ◆ ■  
 3'0" x 8'0"



**CC110B**  
 ◆ ■  
 3'0" x 6'8"



**CC113B**  
 ◆ ■  
 3'0" x 6'8"



**CC112B**  
 ◆ ■  
 3'0" x 6'8"



**CC2080BSL**  
 ▲ ◆ ■  
 12" x 6'8"  
 14" x 6'8"



**CC8010BSL**  
 ▲ ◆ ■  
 12" x 8'0"  
 14" x 8'0"



**CC1020BSL**  
 ▲ ◆ ■  
 12" x 6'8"  
 14" x 6'8"



**BEBHRT**  
 ◆ ■  
 3'0" door + (2) 12" sidelites  
 3'0" door + (2) 14" sidelites  
 Continuous / Boxed Sill Systems



**BEET-B**  
 ◆ ■  
 3'0" door + (2) 12" sidelites  
 3'0" door + (2) 14" sidelites  
 Continuous Sill Systems Only



**BERT-B**  
 ◆ ■  
 3'0" door + (2) 12" sidelites  
 3'0" door + (2) 14" sidelites  
 Continuous Sill Systems Only

### Key

- ▲ Flush-Glazed Glass (FG)
- ◆ Black Nickel Caming (1D)
- Brushed Nickel Caming (1C)
- ❖ Brass Caming (1A)



# Arborwatch®



CC1423  
◆ ■ ■  
3'0" x 6'8"

CC1418  
◆ ■ ■  
3'0" x 6'8"

CC81418  
◆ ■ ■  
3'0" x 8'0"

CC81420  
◆ ■ ■  
3'0" x 8'0"

CC1424  
◆ ■ ■  
3'0" x 6'8"

CC1423SL  
◆ ◆ ■ ■ ■  
12" x 6'8"  
14" x 6'8"

CC81423SL  
◆ ◆ ■ ■ ■  
12" x 8'0"  
14" x 8'0"



ABRT  
◆ ■ ■  
3'0" door + (2) 12" sidelites  
3'0" door + (2) 14" sidelites  
Continuous Sill Systems Only



AB30T  
◆ ■ ■  
3'0" Door Only



Note: See page 273 for important product details that may help with your purchase decision.  
Bottom: Classic-Craft Oak Collection, Provincial Glass, Door – CC97, Sidelites – CC2040SL, Transom – CC420T

# Provincial™



**CC107**  
◆ ◆ ◆ ◆  
3'0" x 6'8"

**CC97**  
◆ ◆ ◆ ◆  
3'0" x 6'8"

**CC897**  
◆ ◆ ◆ ◆  
3'0" x 8'0"

**CC837**  
◆ ◆ ◆ ◆  
3'0" x 8'0"

**CC47**  
◆ ◆ ◆ ◆  
2'8" x 6'8"  
3'0" x 6'8"

**CC77**  
◆ ◆ ◆ ◆  
3'0" x 6'8"

**CC17**  
◆ ◆ ◆ ◆  
3'0" x 6'8"

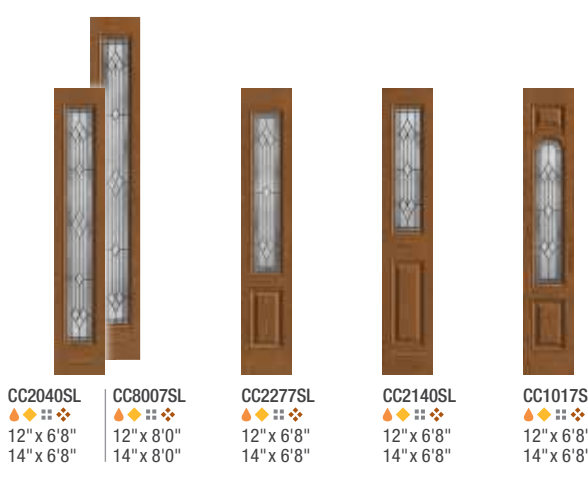

**CC2040SL**  
◆ ◆ ◆ ◆ ◆ ◆ ◆ ◆ ◆ ◆  
12" x 6'8"  
14" x 6'8"

**CC8007SL**  
◆ ◆ ◆ ◆ ◆ ◆ ◆ ◆ ◆ ◆  
12" x 8'0"  
14" x 8'0"

**CC2277SL**  
◆ ◆ ◆ ◆ ◆ ◆ ◆ ◆ ◆ ◆  
12" x 6'8"  
14" x 6'8"

**CC2140SL**  
◆ ◆ ◆ ◆ ◆ ◆ ◆ ◆ ◆ ◆  
12" x 6'8"  
14" x 6'8"

**CC1017SL**  
◆ ◆ ◆ ◆ ◆ ◆ ◆ ◆ ◆ ◆  
12" x 6'8"  
14" x 6'8"



**PRHRT**  
◆ ◆ ◆ ◆ ◆ ◆ ◆ ◆ ◆ ◆  
3'0" door + (2) 12" sidelites  
3'0" door + (2) 14" sidelites  
Continuous / Boxed Sill Systems



**CC40T**  
◆ ◆ ◆ ◆ ◆ ◆ ◆ ◆ ◆ ◆  
3'0" door + (2) 12" sidelites  
3'0" door + (2) 14" sidelites  
Continuous Sill Systems Only

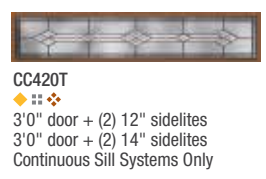

**CC420T**  
◆ ◆ ◆ ◆ ◆ ◆ ◆ ◆ ◆ ◆  
3'0" door + (2) 12" sidelites  
3'0" door + (2) 14" sidelites  
Continuous Sill Systems Only



**CC400T**  
◆ ◆ ◆ ◆ ◆ ◆ ◆ ◆ ◆ ◆  
3'0" Door Only

# Cambridge™



**CC106**  
◆ ◆ ◆ ◆ ◆ ◆ ◆ ◆ ◆ ◆  
3'0" x 6'8"

**CC96**  
◆ ◆ ◆ ◆ ◆ ◆ ◆ ◆ ◆ ◆  
3'0" x 6'8"

**CC896**  
◆ ◆ ◆ ◆ ◆ ◆ ◆ ◆ ◆ ◆  
3'0" x 8'0"

**CC836**  
◆ ◆ ◆ ◆ ◆ ◆ ◆ ◆ ◆ ◆  
3'0" x 8'0"

**CC44**  
◆ ◆ ◆ ◆ ◆ ◆ ◆ ◆ ◆ ◆  
2'8" x 6'8"  
3'0" x 6'8"

**CC76**  
◆ ◆ ◆ ◆ ◆ ◆ ◆ ◆ ◆ ◆  
3'0" x 6'8"

**CC16**  
◆ ◆ ◆ ◆ ◆ ◆ ◆ ◆ ◆ ◆  
3'0" x 6'8"

Cambridge Glass Continues on next page.

- Key**
- ▲ Flush-Glazed Glass (FG)
  - ◆ Black Nickel Caming (1D)
  - Brushed Nickel Caming (1C)
  - ◆ Brass Caming (1A)

Cambridge™ Glass *Continued*



**CC2044SL**  
 ◆◆◆◆  
 12" x 6'8"  
 14" x 6'8"



**CC8006SL**  
 ◆◆◆◆  
 12" x 8'0"  
 14" x 8'0"



**CC2276SL**  
 ◆◆◆◆  
 12" x 6'8"  
 14" x 6'8"



**CC2144SL**  
 ◆◆◆◆  
 12" x 6'8"  
 14" x 6'8"



**CC1016SL**  
 ◆◆◆◆  
 12" x 6'8"  
 14" x 6'8"



**CBHRT**  
 ◆◆◆◆  
 3'0" door + (2) 12" sidelites  
 3'0" door + (2) 14" sidelites  
 Continuous / Boxed Sill Systems



**CC090T**  
 ◆◆◆◆  
 3'0" door + (2) 12" sidelites  
 3'0" door + (2) 14" sidelites  
 Continuous Sill Systems Only



**CC920T**  
 ◆◆◆◆  
 3'0" door + (2) 12" sidelites  
 3'0" door + (2) 14" sidelites  
 Continuous Sill Systems Only



**CC900T**  
 ◆◆◆◆  
 3'0" Door Only

Lucerna®



**CC10022**  
 ◆◆◆◆  
 3'0" x 6'8"

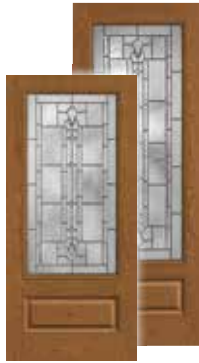

**CC922**  
 ◆◆◆◆  
 3'0" x 6'8"

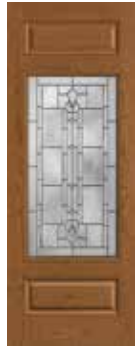

**CC898**  
 ◆◆◆◆  
 3'0" x 8'0"



**CC833**  
 ◆◆◆◆  
 3'0" x 8'0"



**CC612**  
 ◆◆◆◆  
 3'0" x 6'8"



**CC78**  
 ◆◆◆◆  
 3'0" x 6'8"



**CC3412SL**  
 ◆◆◆◆  
 12" x 6'8"  
 14" x 6'8"



**CC8102SL**  
 ◆◆◆◆  
 12" x 8'0"  
 14" x 8'0"



**CC2272SL**  
 ◆◆◆◆  
 12" x 6'8"  
 14" x 6'8"



**CC2122SL**  
 ◆◆◆◆  
 12" x 6'8"  
 14" x 6'8"



**LCHRT**  
 ◆◆◆◆  
 3'0" door + (2) 12" sidelites  
 3'0" door + (2) 14" sidelites  
 Continuous / Boxed Sill Systems



**LCRT**  
 ◆◆◆◆  
 3'0" door + (2) 12" sidelites  
 3'0" door + (2) 14" sidelites  
 Continuous Sill Systems Only



**LCET**  
 ◆◆◆◆  
 3'0" door + (2) 12" sidelites  
 3'0" door + (2) 14" sidelites  
 Continuous Sill Systems Only



**LC30T**  
 ◆◆◆◆  
 3'0" Door Only



# Privacy & Textured Glass with Divided Lites



# Privacy & Textured Glass

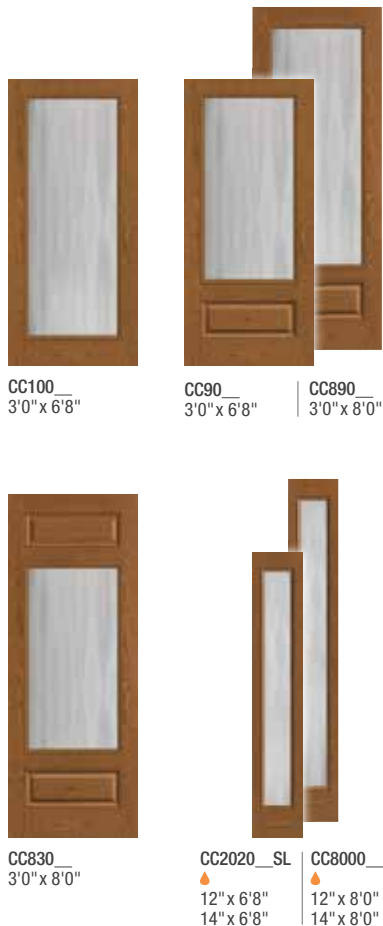

## Privacy & Textured Glass Options

Add the code to the blank in the style number for the desired door and glass combination. For details on glass options, see pages 39–40.

**XC = Chord Glass**  
**XJ = Chinchilla Glass**

**XR = Rainglass**  
**XN = Granite Glass**

## Key

- ▲ Flush-Glazed Glass (FG)
- ◆ Black Nickel Caming (1D)
- Brushed Nickel Caming (1C)
- ❖ Brass Caming (1A)
- Removable Wood Grilles (1R)

# Low-E Glass with Divided Lites



**CC102**  
 \* >  
 3'0" x 6'8"

**CC92** | **CC892**  
 \* >  
 3'0" x 6'8" | 3'0" x 8'0"



**CC49**  
 \* >  
 2'8" x 6'8"  
 3'0" x 6'8"



**CC832**  
 \* >  
 3'0" x 8'0"



**CC2025SL**  
 \* >  
 12" x 6'8"  
 14" x 6'8"



**19020T**  
 \*  
 3'0" door + (2) 12" sidelites  
 3'0" door + (2) 14" sidelites  
 Continuous Sill Systems Only  
 Grille Sticks Applied



**19220T**  
 \*  
 3'0" door + (2) 12" sidelites  
 3'0" door + (2) 14" sidelites  
 Continuous Sill Systems Only  
 Grille Sticks Applied



**19200T**  
 \*  
 3'0" Door Only  
 Grille Sticks Applied

# Low-E Glass



**CC100**  
 \*  
 3'0" x 6'8"

**CC90** | **CC890**  
 \*  
 3'0" x 6'8" | 3'0" x 8'0"



**CC48**  
 \*  
 2'8" x 6'8"  
 3'0" x 6'8"



**CC830**  
 \*  
 3'0" x 8'0"



**CC70**  
 \*  
 3'0" x 6'8"



**CC10**  
 \*  
 3'0" x 6'8"



**CC811**  
 \*  
 3'0" x 8'0"  
 3'6" x 8'0"



**CC61**  
 \*  
 3'0" x 6'8"

**CC2020SL** | **CC8000SL**  
 \* >  
 12" x 6'8" | 12" x 8'0"  
 14" x 6'8" | 14" x 8'0"



**CC2270SL**  
 \* >  
 12" x 6'8"  
 14" x 6'8"



**CC2120SL**  
 \* >  
 12" x 6'8"  
 14" x 6'8"



**CC1010SL**  
 \* >  
 12" x 6'8"  
 14" x 6'8"



**DLHRT**  
 \*  
 3'0" door + (2) 12" sidelites  
 3'0" door + (2) 14" sidelites  
 Continuous / Boxed Sill Systems



**19220T**  
 \*  
 3'0" door + (2) 12" sidelites  
 3'0" door + (2) 14" sidelites  
 Continuous / Boxed Sill Systems



**19020T**  
 \*  
 3'0" door + (2) 12" sidelites  
 3'0" door + (2) 14" sidelites  
 Continuous / Boxed Sill Systems



**19200T**  
 \*  
 3'0" Door Only

# Solid Panel



CC91  
6  
3'0" x 6'8"



CC831  
6  
3'0" x 8'0"



CC40  
3'6" x 6'8"



CC11  
3'0" x 6'8"



CC810  
6  
3'0" x 8'0"  
3'6" x 8'0"



CC60  
6  
2'8" x 6'8"  
3'0" x 6'8"



CC860  
6  
3'6" x 8'0"



## Key

-  Flush-Glazed Glass (FG)
-  Low-E Glass (LE)
-  Removable Wood Grilles (RG)
-  WBDR / HVHZ Options





Classic-Craft<sup>®</sup>  
Entry Doors

**THERMA TRU**  
DOORS



EXCLUSIVE



# Classic-Craft®

## Canvas

## Collection®

- Premium paintable surfaces.

The first premium smooth, paintable fiberglass door to carry the Therma-Tru® brand name, Classic-Craft Canvas is designed for homeowners seeking the aesthetics of a sleek, modern entryway that can be adapted to suit multiple styles.



# Classic-Craft® Canvas Collection®

Creates a sleek, modern entryway with a smooth, paintable surface for virtually unlimited color options both inside and out.



## Architectural Character

- Architecturally correct design – up to 25% wider panels.\*
- Deeper embossments.
- Solid hardwood square edges.
- More than 10% wider glass.\*
- Flush-glazed sidelites.
- Fiberglass lite frames.
- Exclusive glass designs.
- Low-E glass standard.

## Heavier Construction



- 20% heavier construction.\*
- Top and bottom composite rails.
- 4- $\frac{1}{8}$ " full-length engineered lumber lockstile for added weight and rigidity.
- Thicker fiberglass skins.

## Available Sizes

- 3'0" wide doors in 6'8" and 8'0" heights.
- 2- $\frac{1}{2}$ " of height trimmability allows flexibility to fit 80"–82- $\frac{1}{2}$ " and 96"–98- $\frac{1}{2}$ " rough openings.

## Finish Options

Classic-Craft Canvas entryways can be painted any color.

-  WBDR / HVHZ Options: Look for this icon to find door styles that can be configured for WBDR or HVHZ.\*\*
-  Fire-rated options available on solid-panel doors. See pages 227–231.
-  Tru-Defense® Warranty Rider eligible when properly assembled and installed with all Therma-Tru specified system components, in accordance with the Rider.



\*Comparison of Classic-Craft to other standard fiberglass doors with similar styles. Visit [www.thermatru.com](http://www.thermatru.com) for details.

\*\*Please verify that there is a Therma-Tru product approval for the configuration before buying.

Note: Finish colors may vary from an actual application due to fluctuations in finishing or printing. Glass privacy ratings may be more or less than indicated, based on glass design and size of glass. Glass designs may differ from depiction due to size and hand craftsmanship of glass. See your Therma-Tru seller or visit [www.thermatru.com](http://www.thermatru.com) for more, including details on height trimmability, limited warranties and exclusions, Tru-Defense Rider, ENERGY STAR qualified products and product approvals.

Bottom: Classic-Craft Canvas Collection, Borrassa Glass, Door – CCV1515, Straps



# Decorative Glass Designs



**Villager™** Page 97  
Glass Privacy Rating: **5**



**Homeward™** Page 97  
Glass Privacy Rating: **4**



**Arcadia™** Page 98  
Glass Privacy Rating: **5**



**Augustine®** Page 99  
Glass Privacy Rating: **10**



**Ashurst™** Page 99  
Glass Privacy Rating: **8**



**Bella™** Page 100  
Glass Privacy Rating: **6**



**Arborwatch™** Page 101  
Glass Privacy Rating: **6**



**Borrassa™** Page 101  
Glass Privacy Rating: **10**



**Provincial™** Page 102  
Glass Privacy Rating: **6**



**Longford™** Page 103  
Glass Privacy Rating: **8**



**Cambridge™** Page 103  
Glass Privacy Rating: **8**



**Zaha®** Page 104  
Glass Privacy Rating: **3**



**Lucerna™** Page 105  
Glass Privacy Rating: **7**

Also Available:

**Privacy & Textured Glass**

Page 105

**Low-E Glass**

Page 107

Glass Privacy Rating Scale

**1 2 3 4 5 6 7 8 9 10**

Clear

Opaque

**Caming Options**

- ◆ Black Nickel Caming (1D)
- Brushed Nickel Caming (1C)
- ◆ Brass Caming (1A)
- ✕ Wrought Iron (1W)

▶ Simulated divided lites (SDLs) and removable wood grilles available to create authentic Craftsman and Colonial configurations.

## Panel Embossments



4-Panel Square Top  
4-Panel Soft Arch  
Arched 4-Panel Soft Arch  
6-Panel



2-Panel Plank Soft Arch  
Arched 2-Panel Plank Soft Arch



2-Panel Square Top - WS



2-Panel 3/4 Top  
3-Panel  
5-Panel



Craftsman Lite  
1-Panel Plank





# Villager™



CCV9812  
◆ ■ ■  
3'0" x 6'8"

CCV9818 | CCV89818  
◆ ■ ■ | ◆ ■ ■  
3'0" x 6'8" | 3'0" x 8'0"

CCV9821 | CCV89821  
◆ ■ ■ | ◆ ■ ■  
3'0" x 6'8" | 3'0" x 8'0"

CCV9822 | CCV89822  
◆ ■ ■ | ◆ ■ ■  
3'0" x 6'8" | 3'0" x 8'0"

CCV9820  
◆ ■ ■  
3'0" x 6'8"

CCV9811 | CCV89819  
◆ ■ ■ | ◆ ■ ■  
3'0" x 6'8" | 3'0" x 8'0"



CCV89815  
◆ ■ ■  
3'0" x 8'0"



CCV912  
◆ ◆ ■ ■  
3'0" x 6'8"



CCV922  
◆ ◆ ■ ■ ■  
3'0" x 6'8"



CCV932  
◆ ◆ ■ ■ ■  
3'0" x 6'8"

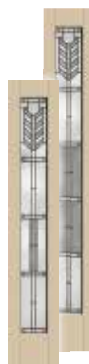

CCV912SL  
◆ ◆ ■ ■ ■  
12" x 6'8"  
14" x 6'8"

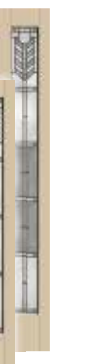

CCV8112SL  
◆ ◆ ■ ■ ■  
12" x 8'0"  
14" x 8'0"



CCV9012SL  
◆ ◆ ■ ■ ■  
12" x 6'8"  
14" x 6'8"



VGRT  
◆ ■ ■  
3'0" door + (2) 12" sidelites  
3'0" door + (2) 14" sidelites  
Continuous Sill Systems Only



VG30T  
◆ ■ ■  
3'0" Door Only

# Homeward™



CCV9925  
◆ ■ ■  
3'0" x 6'8"

CCV9922 | CCV89922  
◆ ■ ■ | ◆ ■ ■  
3'0" x 6'8" | 3'0" x 8'0"

CCV9919 | CCV89919  
◆ ■ ■ | ◆ ■ ■  
3'0" x 6'8" | 3'0" x 8'0"

CCV9918 | CCV89918  
◆ ■ ■ | ◆ ■ ■  
3'0" x 6'8" | 3'0" x 8'0"

CCV9920  
◆ ■ ■  
3'0" x 6'8"

CCV9926 | CCV89921  
◆ ■ ■ | ◆ ■ ■  
3'0" x 6'8" | 3'0" x 8'0"

Homeward Glass Continues on next page.

## Key

- ◆ Flush-Glazed Glass (FG)
- ◆ Black Nickel Caming (1D)
- ■ Brushed Nickel Caming (1C)
- ■ Simulated Divided Lites (SDL)

Note: See page 273 for important product details that may help with your purchase decision.

Left Page: Classic-Craft Canvas Collection, Homeward Glass, Door – CCV9925, Sidelites – CCV911SL, Transom – HWRT

## Optional Dentil Shelf



4-Block Dentil Shelf  
Available for all Craftsman-style Canvas Collection doors.



Homeward™ Glass *Continued*



CCV89924  
◆ ◆  
3'0" x 8'0"



CCV911  
◆ ◆ ◆  
3'0" x 6'8"



CCV921  
◆ ◆ ◆ ◆  
3'0" x 6'8"



CCV931  
◆ ◆ ◆ ◆  
3'0" x 6'8"



CCV911SL  
◆ ◆ ◆  
12" x 6'8"  
14" x 6'8"



CCV8111SL  
◆ ◆ ◆ ◆  
12" x 8'0"  
14" x 8'0"

CCV9011SL  
◆ ◆ ◆ ◆  
12" x 6'8"  
14" x 6'8"



HWRT  
◆ ◆ ◆  
3'0" door + (2) 12" sidelites  
3'0" door + (2) 14" sidelites  
Continuous Sill Systems Only



HW30T  
◆ ◆ ◆  
3'0" Door Only

Arcadia™



CCV10029  
◆ ◆ ◆ ◆  
3'0" x 6'8"



CCV05029  
◆ ◆ ◆ ◆  
3'0" x 6'8"



CCV805029  
◆ ◆ ◆ ◆  
3'0" x 8'0"



CCV20529  
◆ ◆ ◆ ◆  
3'0" x 6'8"



CCV820529  
◆ ◆ ◆ ◆  
3'0" x 8'0"



CCV22029  
◆ ◆ ◆ ◆  
3'0" x 6'8"



CCV822029  
◆ ◆ ◆ ◆  
3'0" x 8'0"



CCV45529  
◆ ◆ ◆ ◆  
3'0" x 6'8"



CCV06029  
◆ ◆ ◆ ◆  
3'0" x 6'8"



CCV806029  
◆ ◆ ◆ ◆  
3'0" x 8'0"



CCV803029  
◆ ◆ ◆ ◆  
3'0" x 8'0"

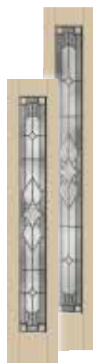

CCV109SL  
◆ ◆ ◆ ◆  
12" x 6'8"  
14" x 6'8"



CCV8109SL  
◆ ◆ ◆ ◆  
12" x 8'0"  
14" x 8'0"



ARHRT  
◆ ◆ ◆ ◆  
3'0" door + (2) 12" sidelites  
3'0" door + (2) 14" sidelites  
Continuous / Boxed Sill Systems



CC620T  
◆ ◆ ◆ ◆  
3'0" door + (2) 12" sidelites  
3'0" door + (2) 14" sidelites  
Continuous Sill Systems Only



CC060T  
◆ ◆ ◆ ◆  
3'0" door + (2) 12" sidelites  
3'0" door + (2) 14" sidelites  
Continuous Sill Systems Only



CC600T  
◆ ◆ ◆ ◆  
3'0" Door Only

# Augustine

Note: Product images show exterior side of door.



CCV10027  
X  
3'0" x 6'8"

CCV05027  
X  
3'0" x 6'8"

CCV805027  
X  
3'0" x 8'0"

CCV20527  
X  
3'0" x 6'8"

CCV820527  
X  
3'0" x 8'0"

CCV22027  
X  
3'0" x 6'8"

CCV822027  
X  
3'0" x 8'0"

CCV45527  
X  
3'0" x 6'8"

CCV20537  
X  
3'0" x 6'8"

CCV820537  
X  
3'0" x 8'0"



CCV45537  
X  
3'0" x 6'8"

CCV20537A  
X  
3'0" x 6'8"

CCV820537A  
X  
3'0" x 8'0"

CCV45537A  
X  
3'0" x 6'8"

CCV803027  
X  
3'0" x 8'0"

CCV806027  
X  
3'0" x 8'0"

CCV100XNSL  
◆  
12" x 6'8"  
14" x 6'8"

CCV8100XNSL  
◆  
12" x 8'0"  
14" x 8'0"

Note:  
Coordinating  
sidelites feature  
granite glass  
without  
wrought iron.

# Ashurst™



CCV10025  
◆  
3'0" x 6'8"

CCV05025  
◆  
3'0" x 6'8"

CCV805025  
◆  
3'0" x 8'0"

CCV20525  
◆  
3'0" x 6'8"

CCV820525  
◆  
3'0" x 8'0"

CCV22025  
◆  
3'0" x 6'8"

CCV822025  
◆  
3'0" x 8'0"

CCV45525  
◆  
3'0" x 6'8"

CCV820535  
◆  
3'0" x 8'0"

Ashurst Glass Continues on next page.

## Key

- ◆ Flush-Glazed Glass (FG)
- ◆ Black Nickel Caming (1D)
- ◆ Brushed Nickel Caming (1C)
- ◆ Brass Caming (1A)
- ✗ Wrought Iron (1W)
- Simulated Divided Lites (SDL)

## Optional Dentil Shelf



4-Block Dentil Shelf  
Available for all Craftsman-style  
Canvas Collection doors.

Ashurst™ Glass *Continued*



**CCV06025**  
◆ ◆  
3'0" x 6'8"

**CCV806025**  
◆ ◆ ◆ ◆  
3'0" x 8'0"



**CCV803025**  
◆ ◆ ◆ ◆  
3'0" x 8'0"



**CCV820535A**  
◆ ◆ ◆ ◆  
3'0" x 8'0"

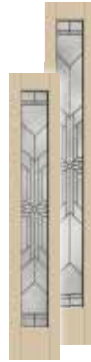

**CCV105SL**  
◆ ◆ ◆ ◆  
12" x 6'8"  
14" x 6'8"

**CCV8105SL**  
◆ ◆ ◆ ◆  
12" x 8'0"  
14" x 8'0"

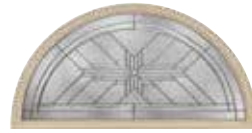

**ASHRT**  
◆ ◆ ◆ ◆  
3'0" door + (2) 12" sidelites  
3'0" door + (2) 14" sidelites  
Continuous / Boxed Sill Systems



**ASET**  
◆ ◆ ◆ ◆  
3'0" door + (2) 12" sidelites  
3'0" door + (2) 14" sidelites  
Continuous Sill Systems Only



**ASRT**  
◆ ◆ ◆ ◆  
3'0" door + (2) 12" sidelites  
3'0" door + (2) 14" sidelites  
Continuous Sill Systems Only



**AS30T**  
◆ ◆ ◆ ◆  
3'0" Door Only

**Bella™**



**CCV10024B**  
◆ ◆ ◆ ◆  
3'0" x 6'8"



**CCV05024B**  
◆ ◆ ◆ ◆  
3'0" x 6'8"

**CCV805024B**  
◆ ◆ ◆ ◆  
3'0" x 8'0"



**CCV20524B**  
◆ ◆ ◆ ◆  
3'0" x 6'8"

**CCV820524B**  
◆ ◆ ◆ ◆  
3'0" x 8'0"



**CCV22024B**  
◆ ◆ ◆ ◆  
3'0" x 6'8"

**CCV822024B**  
◆ ◆ ◆ ◆  
3'0" x 8'0"



**CCV45524B**  
◆ ◆ ◆ ◆  
3'0" x 6'8"



**CCV06024B**  
◆ ◆ ◆ ◆  
3'0" x 6'8"

**CCV806024B**  
◆ ◆ ◆ ◆  
3'0" x 8'0"



**CCV803024B**  
◆ ◆ ◆ ◆  
3'0" x 8'0"



**CCV104BSL**  
◆ ◆ ◆ ◆ ◆ ◆  
12" x 6'8"  
14" x 6'8"

**CCV8104BSL**  
◆ ◆ ◆ ◆ ◆ ◆  
12" x 8'0"  
14" x 8'0"



**BEBHRT**  
◆ ◆ ◆ ◆  
3'0" door + (2) 12" sidelites  
3'0" door + (2) 14" sidelites  
Continuous / Boxed Sill Systems



**BERT-B**  
◆ ◆ ◆ ◆  
3'0" door + (2) 12" sidelites  
3'0" door + (2) 14" sidelites  
Continuous Sill Systems Only



**BEET-B**  
◆ ◆ ◆ ◆  
3'0" door + (2) 12" sidelites  
3'0" door + (2) 14" sidelites  
Continuous Sill Systems Only



# Arborwatch



CCV1423  
◆  
3'0" x 6'8"

CCV1418  
◆  
3'0" x 6'8"

CCV81418  
◆  
3'0" x 8'0"

CCV1415  
◆  
3'0" x 6'8"

CCV81415  
◆  
3'0" x 8'0"

CCV1414  
◆  
3'0" x 6'8"

CCV81414  
◆  
3'0" x 8'0"

CCV1416  
◆  
3'0" x 6'8"

CCV1424  
◆  
3'0" x 6'8"

CCV81417  
◆  
3'0" x 8'0"

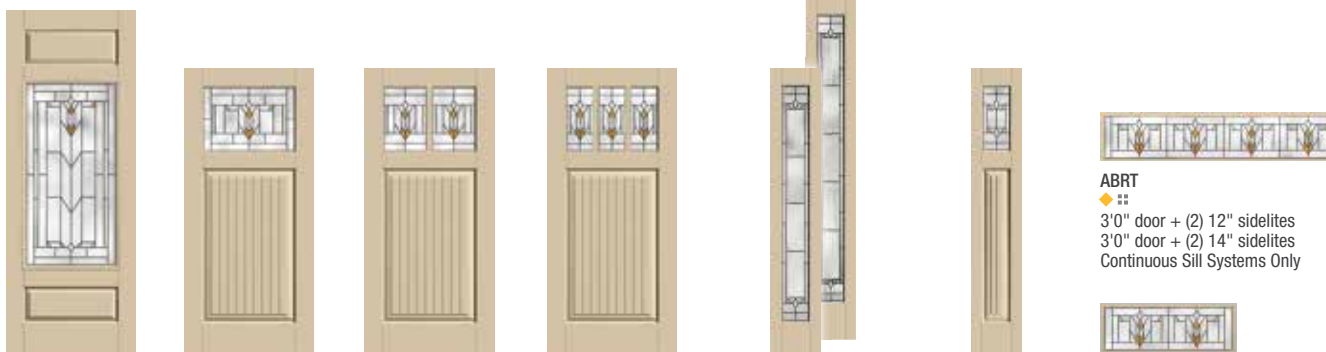

CCV81420  
◆  
3'0" x 8'0"

CCV4100  
◆  
3'0" x 6'8"

CCV4200  
◆  
3'0" x 6'8"

CCV4300  
◆  
3'0" x 6'8"

CCV1423SL  
◆  
12" x 6'8"  
14" x 6'8"

CCV81423SL  
◆  
12" x 8'0"  
14" x 8'0"

CCV4100SL  
◆  
12" x 6'8"  
14" x 6'8"

ABRT  
◆  
3'0" door + (2) 12" sidelites  
3'0" door + (2) 14" sidelites  
Continuous Sill Systems Only



AB30T  
◆  
3'0" Door Only

# Borrassa

Note: Product images show exterior side of door.



CCV1528  
X  
3'0" x 6'8"

CCV1519  
X  
3'0" x 6'8"

CCV81519  
X  
3'0" x 8'0"

CCV1516  
X  
3'0" x 6'8"

CCV81516  
X  
3'0" x 8'0"

CCV1515  
X  
3'0" x 6'8"

CCV81515  
X  
3'0" x 8'0"

CCV1517  
X  
3'0" x 6'8"

CCV1512  
X  
3'0" x 6'8"

CCV81512  
X  
3'0" x 8'0"

Borrassa Glass Continues on next page.

## Key

- ◆ Flush-Glazed Glass (FG)
- ◆ Black Nickel Caming (1D)
- ◆ Brushed Nickel Caming (1C)

- X Wrought Iron (1W)
- ◆ Simulated Divided Lites (SDL)

## Optional Dentil Shelf



**Borrassa® Glass** *Continued*

Note: Product images show exterior side of door.



CCV1513  
✗  
3'0" x 6'8"

CCV1512A  
✗  
3'0" x 6'8"

CCV81512A  
✗  
3'0" x 8'0"



CCV1513A  
✗  
3'0" x 6'8"



CCV81518  
✗  
3'0" x 8'0"



CCV81520  
✗  
3'0" x 8'0"



CCV100XHSL  
▲  
12" x 6'8"  
14" x 6'8"

CCV8100XHSL  
▲  
12" x 8'0"  
14" x 8'0"

Note: Coordinating sidelites feature hammered glass without wrought iron.

# Provincial™



CCV10028  
◆◆◆  
3'0" x 6'8"



CCV05028  
◆◆◆  
3'0" x 6'8"

CCV805028  
◆◆◆  
3'0" x 8'0"



CCV20528  
◆◆◆  
3'0" x 6'8"

CCV820528  
◆◆◆  
3'0" x 8'0"



CCV22028  
◆◆◆  
3'0" x 6'8"

CCV822028  
◆◆◆  
3'0" x 8'0"



CCV45528  
◆◆◆  
3'0" x 6'8"



CCV06028  
◆◆◆  
3'0" x 6'8"

CCV806028  
◆◆◆  
3'0" x 8'0"



CCV803028  
◆◆◆  
3'0" x 8'0"



CCV108SL  
◆◆◆  
12" x 6'8"  
14" x 6'8"

CCV8108SL  
◆◆◆  
12" x 8'0"  
14" x 8'0"



PRHRT

◆◆◆  
3'0" door + (2) 12" sidelites  
3'0" door + (2) 14" sidelites  
Continuous / Boxed Sill Systems



CC420T

◆◆◆  
3'0" door + (2) 12" sidelites  
3'0" door + (2) 14" sidelites  
Continuous Sill Systems Only



CC040T

◆◆◆  
3'0" door + (2) 12" sidelites  
3'0" door + (2) 14" sidelites  
Continuous Sill Systems Only



CC400T

◆◆◆  
3'0" Door Only

# Longford™



CCV10023  
◆ ◆ ◆  
3'0" x 6'8"

CCV05023  
◆ ◆ ◆  
3'0" x 6'8"

CCV805023  
◆ ◆ ◆  
3'0" x 8'0"

CCV20523  
◆ ◆ ◆  
3'0" x 6'8"

CCV820523  
◆ ◆ ◆  
3'0" x 8'0"

CCV22023  
◆ ◆ ◆  
3'0" x 6'8"

CCV822023  
◆ ◆ ◆  
3'0" x 8'0"

CCV45523  
◆ ◆ ◆  
3'0" x 6'8"

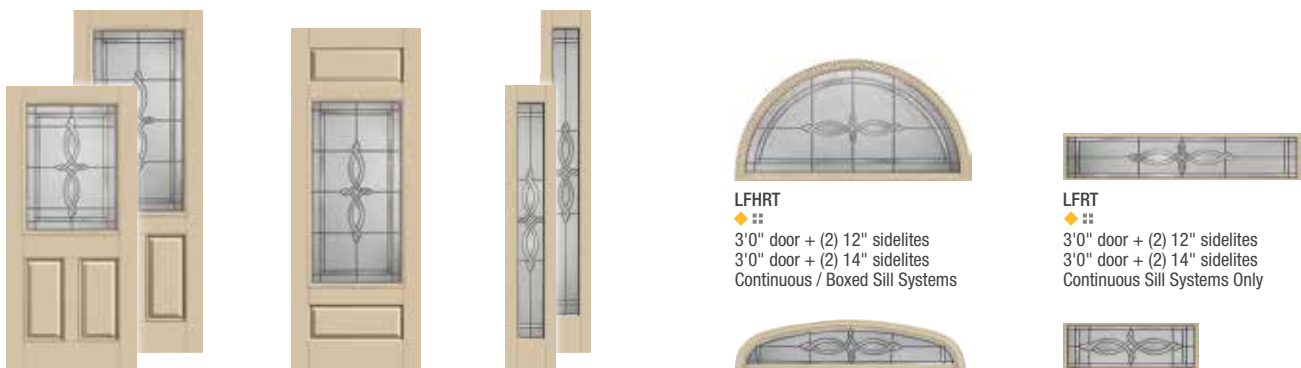

CCV60023  
◆ ◆ ◆  
3'0" x 6'8"

CCV806023  
◆ ◆ ◆  
3'0" x 8'0"

CCV803023  
◆ ◆ ◆  
3'0" x 8'0"

CCV103SL  
◆ ◆ ◆ ◆  
12" x 6'8"  
14" x 6'8"

CCV8103SL  
◆ ◆ ◆ ◆  
12" x 8'0"  
14" x 8'0"

LFHRT

◆ ◆ ◆  
3'0" door + (2) 12" sidelites  
3'0" door + (2) 14" sidelites  
Continuous / Boxed Sill Systems

LFRT

◆ ◆ ◆  
3'0" door + (2) 12" sidelites  
3'0" door + (2) 14" sidelites  
Continuous Sill Systems Only

LFET

◆ ◆ ◆  
3'0" door + (2) 12" sidelites  
3'0" door + (2) 14" sidelites  
Continuous Sill Systems Only

LF30T

◆ ◆ ◆  
3'0" Door Only

# Cambridge™



CCV10026  
◆ ◆ ◆ ◆  
3'0" x 6'8"

CCV05026  
◆ ◆ ◆ ◆  
3'0" x 6'8"

CCV805026  
◆ ◆ ◆ ◆  
3'0" x 8'0"

CCV20526  
◆ ◆ ◆ ◆  
3'0" x 6'8"

CCV820526  
◆ ◆ ◆ ◆  
3'0" x 8'0"

CCV22026  
◆ ◆ ◆ ◆  
3'0" x 6'8"

CCV822026  
◆ ◆ ◆ ◆  
3'0" x 8'0"

CCV45526  
◆ ◆ ◆ ◆  
3'0" x 6'8"

Cambridge Glass Continues on next page.

## Key

- ◆ Flush-Glazed Glass (FG)
- ◆ Black Nickel Caming (1D)
- ◆ Brushed Nickel Caming (1C)
- ◆ Brass Caming (1A)
- ✗ Wrought Iron (1W)



**Cambridge™ Glass** *Continued*



**CCV06026**  
◆ ◆ ◆  
3'0" x 6'8"

**CCV806026**  
◆ ◆ ◆  
3'0" x 8'0"



**CCV803026**  
◆ ◆ ◆  
3'0" x 8'0"



**CCV106SL**  
◆ ◆ ◆ ◆  
12" x 6'8"  
14" x 6'8"

**CCV8106SL**  
◆ ◆ ◆ ◆  
12" x 8'0"  
14" x 8'0"



**CBHRT**  
◆ ◆ ◆ ◆  
3'0" door + (2) 12" sidelites  
3'0" door + (2) 14" sidelites  
Continuous / Boxed Sill Systems



**CC920T**  
◆ ◆ ◆ ◆  
3'0" door + (2) 12" sidelites  
3'0" door + (2) 14" sidelites  
Continuous Sill Systems Only



**CC090T**  
◆ ◆ ◆ ◆  
3'0" door + (2) 12" sidelites  
3'0" door + (2) 14" sidelites  
Continuous Sill Systems Only



**CC900T**  
◆ ◆ ◆ ◆  
3'0" Door Only

**Zaha®**

Note: Product images show exterior side of door.



**CCV1851**  
◆ ◆ ◆  
3'0" x 6'8"



**CCV1843**  
◆ ◆ ◆  
3'0" x 6'8"

**CCV81843**  
◆ ◆ ◆  
3'0" x 8'0"



**CCV1839**  
◆ ◆ ◆  
3'0" x 6'8"

**CCV81839**  
◆ ◆ ◆  
3'0" x 8'0"



**CCV1838**  
◆ ◆ ◆  
3'0" x 6'8"

**CCV81838**  
◆ ◆ ◆  
3'0" x 8'0"



**CCV1840**  
◆ ◆ ◆  
3'0" x 6'8"



**CCV81841**  
◆ ◆ ◆  
3'0" x 8'0"



**CCV81840**  
◆ ◆ ◆  
3'0" x 8'0"



**CCV81846**  
◆ ◆ ◆  
3'0" x 8'0"



**CCV81846A**  
◆ ◆ ◆  
3'0" x 8'0"

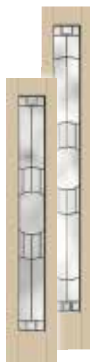

**CCV1851SL**  
◆ ◆ ◆ ◆  
12" x 6'8"  
14" x 6'8"

**CCV81851SL**  
◆ ◆ ◆ ◆  
12" x 8'0"  
14" x 8'0"



**ZHHRT**  
◆ ◆ ◆ ◆  
3'0" door + (2) 12" sidelites  
3'0" door + (2) 14" sidelites  
Continuous / Boxed Sill Systems



**ZHRT**  
◆ ◆ ◆ ◆  
3'0" door + (2) 12" sidelites  
3'0" door + (2) 14" sidelites  
Continuous Sill Systems Only

**Privacy & Textured Glass Options**

Add the code to the blank in the style number for the desired door and glass combination. For details on glass options, see pages 39–40.

**XC = Chord Glass**

**XJ = Chinchilla Glass**

**XR = Rainglass**

**XN = Granite Glass**

# Lucerna

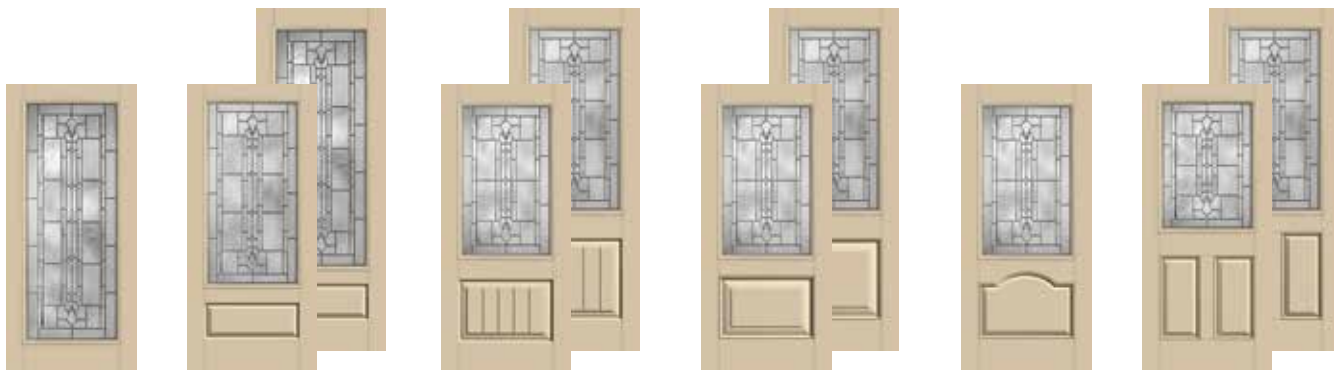

|  |  |   |  |   |  |   |  |  |   |
|--|--|---|--|---|--|---|--|--|---|
| <b>CCV10022</b><br>◆ ■■<br>3'0" x 6'8" | <b>CCV05022</b><br>◆ ■■<br>3'0" x 6'8" | <b>CCV805022</b><br>◆ ■■<br>3'0" x 8'0" | <b>CCV20522</b><br>◆ ■■<br>3'0" x 6'8" | <b>CCV820522</b><br>◆ ■■<br>3'0" x 8'0" | <b>CCV22022</b><br>◆ ■■<br>3'0" x 6'8" | <b>CCV822022</b><br>◆ ■■<br>3'0" x 8'0" | <b>CCV45522</b><br>◆ ■■<br>3'0" x 6'8" | <b>CCV06022</b><br>◆ ■■<br>3'0" x 6'8" | <b>CCV806022</b><br>◆ ■■<br>3'0" x 8'0" |
|--|--|---|--|---|--|---|--|--|---|

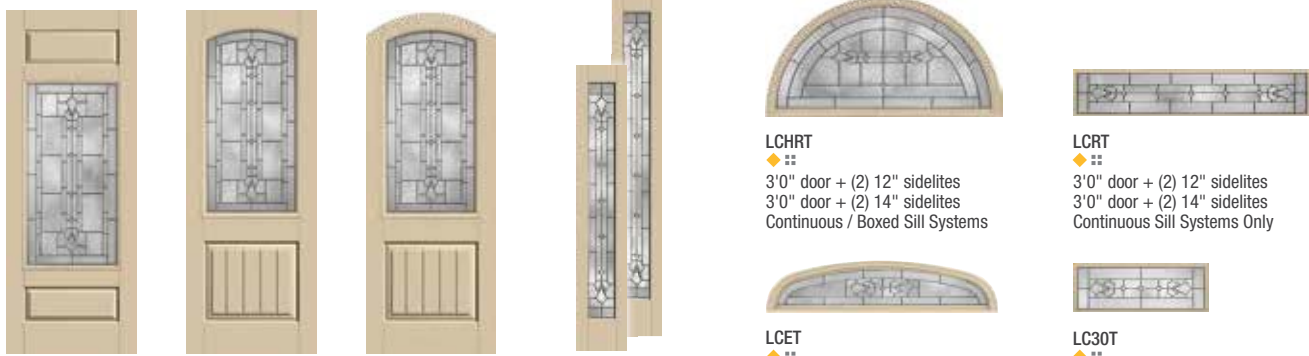

|   |   |  |   |   |   |   |   |  |
|---|---|--|---|---|---|---|---|--|
| <b>CCV803022</b><br>◆ ■■<br>3'0" x 8'0" | <b>CCV820532</b><br>◆ ■■<br>3'0" x 8'0" | <b>CCV820532A</b><br>◆ ■■<br>3'0" x 8'0" | <b>CCV3412SL</b><br>▲ ◆ ◆ ◆<br>12" x 6'8"<br>14" x 6'8" | <b>CCV8102SL</b><br>▲ ◆ ◆ ◆<br>12" x 8'0"<br>14" x 8'0" | <b>LCVRT</b><br>◆ ■■<br>3'0" door + (2) 12" sidelites<br>3'0" door + (2) 14" sidelites<br>Continuous / Boxed Sill Systems | <b>LCRT</b><br>◆ ■■<br>3'0" door + (2) 12" sidelites<br>3'0" door + (2) 14" sidelites<br>Continuous Sill Systems Only | <b>LCET</b><br>◆ ■■<br>3'0" door + (2) 12" sidelites<br>3'0" door + (2) 14" sidelites<br>Continuous Sill Systems Only | <b>LC30T</b><br>◆ ■■<br>3'0" Door Only |
|---|---|--|---|---|---|---|---|--|

## Privacy & Textured Glass with Divided Lites

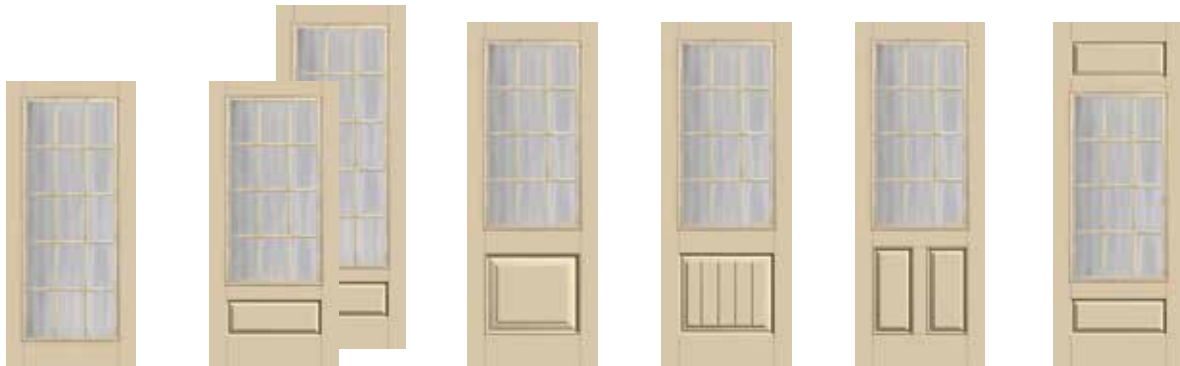

|                                     |                                     |                                      |                                      |                                      |                                      |                                      |
|-------------------------------------|-------------------------------------|--------------------------------------|--------------------------------------|--------------------------------------|--------------------------------------|--------------------------------------|
| <b>CCV10015</b><br>><br>3'0" x 6'8" | <b>CCV05012</b><br>><br>3'0" x 6'8" | <b>CCV805015</b><br>><br>3'0" x 8'0" | <b>CCV822012</b><br>><br>3'0" x 8'0" | <b>CCV820512</b><br>><br>3'0" x 8'0" | <b>CCV806012</b><br>><br>3'0" x 8'0" | <b>CCV803012</b><br>><br>3'0" x 8'0" |
|-------------------------------------|-------------------------------------|--------------------------------------|--------------------------------------|--------------------------------------|--------------------------------------|--------------------------------------|

Privacy & Textured Glass with Divided Lites *Continues on next page.*

### Key

- Flush-Glazed Glass (FG)
- ◆ Black Nickel Caming (1D)
- ■ ■ Brushed Nickel Caming (1C)
- ◆ ■ ■ ■ Brass Caming (1A)
- > Removable Wood Grilles (RG)

Privacy & Textured Glass with Divided Lites *Continued*



## Privacy & Textured Glass



### Privacy & Textured Glass Options

Add the code to the blank in the style number for the desired door and glass combination. For details on glass options, see pages 39–40.

XC = Chord Glass  
XR = Rainglass  
XJ = Chinchilla Glass  
XN = Granite Glass



# Low-E Glass with Divided Lites



CCV10015  
 \* >  
 3'0" x 6'8"

CCV05012  
 \* >  
 3'0" x 6'8"

CCV805015  
 \* >  
 3'0" x 8'0"

CCV822012  
 \* >  
 3'0" x 8'0"

CCV820512  
 \* >  
 3'0" x 8'0"

CCV0609  
 \* >  
 3'0" x 6'8"

CCV806012  
 \* >  
 3'0" x 8'0"

CCV803012  
 \* >  
 3'0" x 8'0"



CCV920  
 \* \* \*  
 3'0" x 6'8"

CCV930  
 \* \* \*  
 3'0" x 6'8"

CCV940  
 \* \* \*  
 3'0" x 6'8"

CCV960  
 \* \* \*  
 3'0" x 6'8"

CCV950SL  
 \* \* \*  
 12" x 6'8"  
 14" x 6'8"

CCV8950SL  
 \* \* \*  
 12" x 6'8"  
 14" x 6'8"

CCV9020SL  
 \* \* \*  
 12" x 6'8"  
 14" x 6'8"

# Low-E Glass



CCV10020  
 \*  
 3'0" x 6'8"

CCV05020  
 \*  
 3'0" x 6'8"

CCV805020  
 \*  
 3'0" x 8'0"

CCV20520  
 \*  
 3'0" x 6'8"

CCV820520  
 \*  
 3'0" x 8'0"

CCV22020  
 \*  
 3'0" x 6'8"

CCV822020  
 \*  
 3'0" x 8'0"

CCV45520  
 \*  
 3'0" x 6'8"

Low-E Glass *Continues on next page.*

## Key

- Flush-Glazed Glass (FG)
- Low-E Glass (LE)
- Simulated Divided Lites (SDL)
- Removable Wood Grilles (RG)

## Optional Dentil Shelf

- 4-Block Dentil Shelf  
 Available for all Craftsman-style Canvas Collection doors.

## Low-E Glass *Continued*



**CCV06020** | **CCV806020**  
 \* 3'0" x 6'8" | \* 3'0" x 8'0"



**CCV910**  
 \* 3'0" x 6'8"



**CCV803020**  
 \* 3'0" x 8'0"



**CCV820530**  
 \* 3'0" x 8'0"



**CCV820530A**  
 \* 3'0" x 8'0"



**CCV100SL** | **CCV8100SL**  
 \* 12" x 6'8" | \* 12" x 8'0"  
 \* 14" x 6'8" | \* 14" x 8'0"



**CCV9010SL**  
 \* 12" x 6'8"  
 \* 14" x 6'8"



**DLHRT**  
 \* 3'0" door + (2) 12" sidelites  
 3'0" door + (2) 14" sidelites  
 Continuous / Boxed Sill Systems



**19020T**  
 \* 3'0" door + (2) 12" sidelites  
 3'0" door + (2) 14" sidelites  
 Continuous / Boxed Sill Systems



**19220T**  
 \* 3'0" door + (2) 12" sidelites  
 3'0" door + (2) 14" sidelites  
 Continuous / Boxed Sill Systems



**19200T**  
 \* 3'0" Door Only



**19210T**  
 \* 12" & 14" Sidelite Only

## Solid Panel



**CCV400**  
 6 3'0" x 6'8"



**CCV205**  
 6 3'0" x 6'8"



**CCV8205** | **CCV205A**  
 6 3'0" x 8'0" | 6 3'0" x 8'0"



**CCV455**  
 6 3'0" x 6'8"



**CCV455A**  
 6 3'0" x 6'8"



**CCV220** | **CCV8220**  
 6 3'0" x 6'8" | 6 3'0" x 8'0"



**CCV200**  
 6 3'0" x 6'8"



**CCV060** | **CCV860**  
 6 3'0" x 6'8" | 6 3'0" x 8'0"



**CCV831**  
 6 3'0" x 8'0"



**CCV050**  
 6 3'0" x 6'8"



Note: See page 273 for important product details that may help with your purchase decision.

Bottom: Classic-Craft Canvas Collection Door – CCV455; Ashurst Glass, Sidelites – CCV105SL, Transom – ASET

### Key

- Flush-Glazed Glass (FG)
- Low-E Glass (LE)
- WBDR / HVHZ Options

### Optional Dentil Shelf

**4-Block Dentil Shelf**  
 Available for all Craftsman-style Canvas Collection doors.



Top: Classic-Craft Canvas Collection, Zaha Glass, Door – CCV813838  
Bottom Left: Classic-Craft Rustic Collection, Borrassa Glass, Door – CCR1528; Hammered Glass, Sidelites – CCR3400XHSL  
Bottom Right: Classic-Craft Rustic Collection, Augustine Glass, Door – CCR820537A



# Fiber-Classic®

Mahogany Collection™ & Oak Collection™



110

- Wood grains to suit any style.



Choose from two wood-grained collections for the perfect fiberglass door to fit a variety of home styles at an excellent value. Fiber-Classic Mahogany complements rich wood tones in home interiors, extending the look to the outside with beauty and elegance. Fiber-Classic Oak is the door that started the fiberglass revolution, featuring the distinctive look of natural Oak graining.

Top: Fiber-Classic Oak Collection, Riserva Glass, Door – FC8529, Sidelites – FC8572SL  
 Bottom: Fiber-Classic Mahogany Collection, Concorde Glass, Door – FCM911, Sidelite – FCM809SL



# Smooth-Star®



Smooth, paintable surfaces.



Smooth-Star is the answer when the best look for the home is delivered in a sleek, paintable package. The more attractive and durable alternative to steel, Smooth-Star fiberglass doors are ready-to-paint with crisp, clean contours that meet the needs of homeowners seeking more color options for their doorways.

Top: Smooth-Star, Sedona Glass, Door – S91, Sidelites – S139SL, Transom – 19520T  
Bottom: Smooth-Star, Low-E Glass with SDLs, Door – S84812

# Fiber-Classic® & Smooth-Star® Fiberglass Doors

Therma-Tru gives the homeowner options to choose the style that best fits their personality and home without compromise. Fiber-Classic and Smooth-Star share many door styles in common. And the available glass families cross over between door collections. Find flexible options to fit virtually every entrance from front entry to patio to utility doors.





## Fiber-Classic & Smooth-Star fiberglass doors offer:

- High-definition panel embossments.
- Composite top and bottom rails.
- 1-¼" engineered lumber lock stiles.
- 22-½" lock block in Fiber-Classic and 12-½" lock block in Smooth-Star.
- Durable, long-lasting fiberglass skins.

 WBDR Options: Look for this icon to find door styles that can be configured for WBDR.\*

 WBDR / HVHZ Options: Look for this icon to find door styles that can be configured for WBDR or HVHZ.\*

 Fire-rated options available on solid-panel doors. See pages 227–231.

 Tru-Defense® Warranty Rider eligible when properly assembled and installed with all Therma-Tru specified system components, in accordance with the Rider.



## Fiber-Classic® Mahogany Collection™

Features deep Mahogany graining to complement homes with richer wood tones.



## Fiber-Classic® Oak Collection™

Features the warm look and feel of Oak graining.



## Smooth-Star®

Features smooth, ready-to-paint surfaces.

\*Please verify that there is a Therma-Tru product approval for the configuration before buying.

Note: Finish colors may vary from an actual application due to fluctuations in finishing or printing. See your Therma-Tru seller or visit [www.thermatru.com](http://www.thermatru.com) for more, including details on limited warranties and exclusions, Tru-Defense Rider, ENERGY STAR qualified products and product approvals.



## Vented Sidelites



- = Available
- = Not Applicable
- S = Stain
- P = Paint

|  | Fiber-Classic <sup>®</sup><br>Mahogany Collection <sup>™</sup> | Fiber-Classic <sup>®</sup><br>Oak Collection <sup>™</sup> | Smooth-Star <sup>®</sup> |
|--|--|---|--------------------------|
|--|--|---|--------------------------|

### Door Widths

|       |   |   |   |
|-------|---|---|---|
| 2'0"  | ■ | ■ | ■ |
| 2'4"  | ■ | ■ | ■ |
| 2'6"  | ■ | ■ | ■ |
| 2'8"  | ■ | ■ | ■ |
| 2'10" | ■ | ■ | ■ |
| 3'0"  | ■ | ■ | ■ |
| 3'6"  | • | • | ■ |

### Door Heights

|      |   |   |   |
|------|---|---|---|
| 6'6" | ■ | ■ | ■ |
| 6'8" | ■ | ■ | ■ |
| 7'0" | ■ | ■ | ■ |
| 8'0" | ■ | ■ | ■ |

### Glass Options

|                         |    |    |    |
|-------------------------|----|----|----|
| Decorative              | 14 | 14 | 14 |
| Privacy & Textured      | 5  | 5  | 5  |
| Internal Blinds         | ■  | ■  | ■  |
| Flush-Glazed            | •  | ■  | ■  |
| Screen Vented           | •  | •  | ■  |
| Simulated Divided Lites | ■  | ■  | ■  |
| Grilles Between Glass   | ■  | ■  | ■  |
| Removable Wood Grilles  | ■  | ■  | ■  |
| Fixed Grilles           | ■  | ■  | ■  |
| Low-E                   | ■  | ■  | ■  |
| Clear                   | ■  | ■  | ■  |

### Additional Options

| Finish           | S / P | S / P | P |
|------------------|-------|-------|---|
| Vented Sidelites | ■     | ■     | ■ |

More than a sidelite. Vented sidelites from Therma-Tru let the homeowner enjoy the added curb appeal of an elegant front entry unobstructed by a screen door. Choose from convenient specialty glass options or eye-catching decorative designs. In fact, only Therma-Tru offers vented sidelites with decorative glass. Look for the (●) icon.

- Sturdy stiles and hinges make the unit work as a small swinging door.
- Wide patio mullions provide dependable operation.
- Multi-point lock and continuous system help provide security and stability.
- Convenient removable screens – available in bronze and white – are designed for worry-free use.

### Available Configurations:



Single Door with Vented Sidelites (Inswing Only)



Double Doors with Vented Sidelites (Inswing Only)

Note: No Impact options available for vented sidelites.  
Top: Smooth-Star Door – S8200; Granite Glass, Sidelites – S81086XNSL

## Retrofit Hinged Patio Doors

Replacing common slider sizes? Find hinged patio door options in this section. For more about our patio door systems, see pages 246–248.

5'0" Patio Opening = (2) 2'4" Doors

6'0" Patio Opening = (2) 2'10" Doors



## SAME-DAY STAIN

See the difference stain can make. Kit available in seven finish colors on pages 264–265.

# Decorative & Specialty Glass Designs

## Blackstone® Page 125

Traditional English design meets  
**1** clear curved bevels, **2** rainglass  
 and coming to create the distinctive  
 styling of Blackstone. Entries get  
 the best of both privacy and  
 simple refinement.

1 **7** 10  
 Glass Privacy Rating

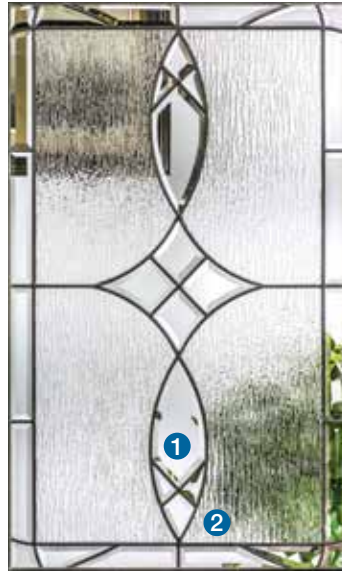

Black Nickel



Brushed Nickel

## Crystalline™ Page 128

This time-honored design features  
 geometric styling brought to life  
 with **1** glue chip glass, **2** glue chip  
 bevels, **3** clear bevels and coming.  
 Offering modest privacy, Crystalline  
 is a shining example of traditional  
 decorative glass with lasting beauty.

1 **7** 10  
 Glass Privacy Rating



Black Nickel



Brushed Nickel



Brass

## Sedona Page 131

Art meets glass in Sedona where Arts  
 and Crafts simplicity is designed with  
**1** slump glass, **2** clear bevels, **3** clear  
 antique glass and coming. Sedona Art  
 glass featuring ruby red granite glass is  
 also available with black nickel coming.

1 **7** 10  
 Glass Privacy Rating



Art Glass /  
 Black Nickel



Black Nickel



Brushed Nickel

Note: Glass privacy ratings may be more or less than indicated, based on glass design and size of glass. Glass designs may differ from depiction due to size and hand craftsmanship of glass. See your Therma-Tru seller or visit [www.thermatru.com](http://www.thermatru.com) for more details.

**Salinas**® Page 134

1 Oceana glass and wrought iron come together to create a cheerful entry glass design that offers the ultimate in privacy with yesterday's charm.

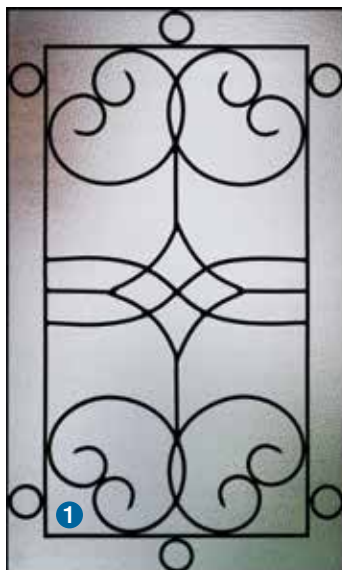

Wrought Iron

**Maple Park**® Page 137

With hints of Mission style and the American Southwest, Maple Park provides a sophisticated appearance with 1 waterglass, 2 clear bevels, 3 granite glass and caming. The curved design adds unique appeal.



Black Nickel



Brushed Nickel

**Avonlea**® Page 140

The dainty leaf design seemingly grows upward in this elegant glass design. Light pours through Avonlea's 1 clear baroque glass and 2 bronze waterglass surrounded by black nickel caming.



Black Nickel



## Saratoga™ Page 142

Saratoga evokes a certain urban sophistication while offering modest privacy with its ① clear bevels, ② diamond glass, ③ reed glass and coming. The geometric pattern bridges both modern and traditional designs.



Black Nickel

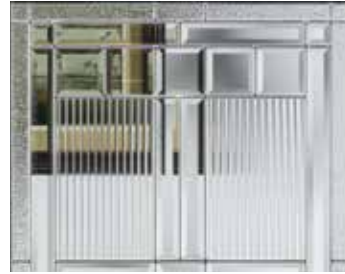

Brushed Nickel

## Texas Star Page 144

Beautifully crafted with ① clear bevels, ② curved bevels, ③ clear waterglass, ④ granite glass, ⑤ glue chip glass and brushed nickel coming, there's no mistaking the inspiration for this recognizable design. Strong, independent and all-American.



Brushed Nickel

## Wellesley™ Page 146

Simple yet charming, Wellesley's Victorian-inspired design uses ① clear baroque glass, ② clear curved bevels, ③ waterglass, ④ granite glass and coming to add beauty to any entry.

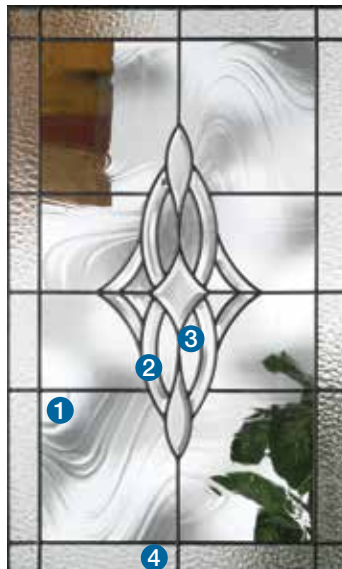

Black Nickel



Brushed Nickel



Brass

Note: Glass privacy ratings may be more or less than indicated, based on glass design and size of glass. Glass designs may differ from depiction due to size and hand craftsmanship of glass. See your Therma-Tru seller or visit [www.thermatru.com](http://www.thermatru.com) for more details.

## Riserva™ Page 149

Riserva decorative glass features a combination of linear and curved wrought iron elements that create a simple yet graceful design. Riserva features **1** oceana glass for privacy with a look that enhances a wide variety of home styles, including Mediterranean, Old World and Southwest.



Glass Privacy Rating

Wrought Iron

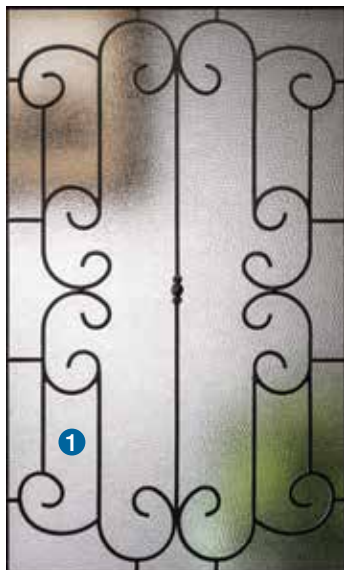

## Concorde™ Page 152

There's just something friendly about Concorde's cheery four-leaf design.

**1** Glue chip glass, **2** clear curved bevels, **3** clear glass and coming make up its Old World charm.



Glass Privacy Rating

Black Nickel



Brushed Nickel



Brass

## Kensington™ Page 155

Kensington speaks European elegance while offering modest privacy with its

**1** clear bevels, **2** glue chip glass, **3** granite glass and coming.



Glass Privacy Rating

Black Nickel



Brushed Nickel

## Axis™ Page 158

Simple and smart, Axis combines  
 ① narrow reed glass in horizontal and vertical arrangements to create contrast and modest privacy. A vertical band of ② clear glass bevels completes this linear design, ideal for Modern home styles.



Glass Privacy Rating

Black Nickel



## Frosted Images®

Page 161

Delicate and ornate, Frosted Images offers a high privacy rating with an elegant aesthetic achieved with the simplicity of

① white-frosted glass.



Glass Privacy Rating



## Internal Blinds Page 174

Internal blinds provide the privacy and convenience of a cordless blind enclosed between glass. A single-hand operator opens, closes and tilts the blinds to control the desired level of privacy and light.

- ① Single-Hand Operator
- ② Privacy Bar

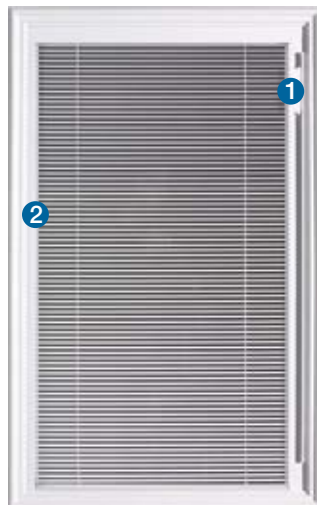

## Screen Vented Page 176

Screen vented lites offer a built-in screen for ventilation, featuring a gliding operation and sash locking system.



Note: Glass privacy ratings may be more or less than indicated, based on glass design and size of glass. Glass designs may differ from depiction due to size and hand craftsmanship of glass. See your Therma-Tru seller or visit [www.thermatru.com](http://www.thermatru.com) for more details.



# Privacy & Textured Glass Page 163



**Satin Etch Glass**



Glass Privacy Rating



**Chord Glass**



Glass Privacy Rating



**Chinchilla Glass**



Glass Privacy Rating



**Rainglass**



Glass Privacy Rating



**Granite Glass**



Glass Privacy Rating

Also Available:  
**Clear Glass** Page 177

# Divided Lites Pages 163, 167, 177, 183

## Simulated Divided Lites with Grilles Between Glass

Choose wood-grained or smooth-textured SDL bars layered over flat bronze GBG bars to achieve the most authentic divided lite look.

Look for the (   ) icons.



Shown with flat bronze GBGs, recommended.

## Simulated Divided Lites (SDLs)

Wood-grained or smooth SDL bars are adhered to the interior and exterior panes of tempered glass. Can be stained or painted to complement the door and home.

Look for the (   ) icons.



## Grilles Between Glass (GBGs)

Contour or flat GBG bars are thermally sealed between two panes of tempered glass for the convenience of a smooth, easy-to-clean glass surface.

Look for the (   ) icons.



## Removable Wood Grilles

Removable wood grilles snap on and off the interior pane of tempered glass for easy cleaning. Can be stained or painted to complement the home décor.

Look for the (  ) icon.



Interior view.

\*Available in Special Quote Program.

\*\*Not recommended for use behind storm doors or to be painted dark colors, if exposed to direct sunlight.

Note: See page 273 for important product details that may help with your purchase decision.

Right Page: Fiber-Classic Mahogany Collection, Clear Glass with SDLs, Door – FCM608

### Fixed Grilles

Fixed grilles are molded as part of the lite frame on the interior and exterior panes of tempered glass. Can be stained or painted to complement the home décor.

Look for the (◆) icon.

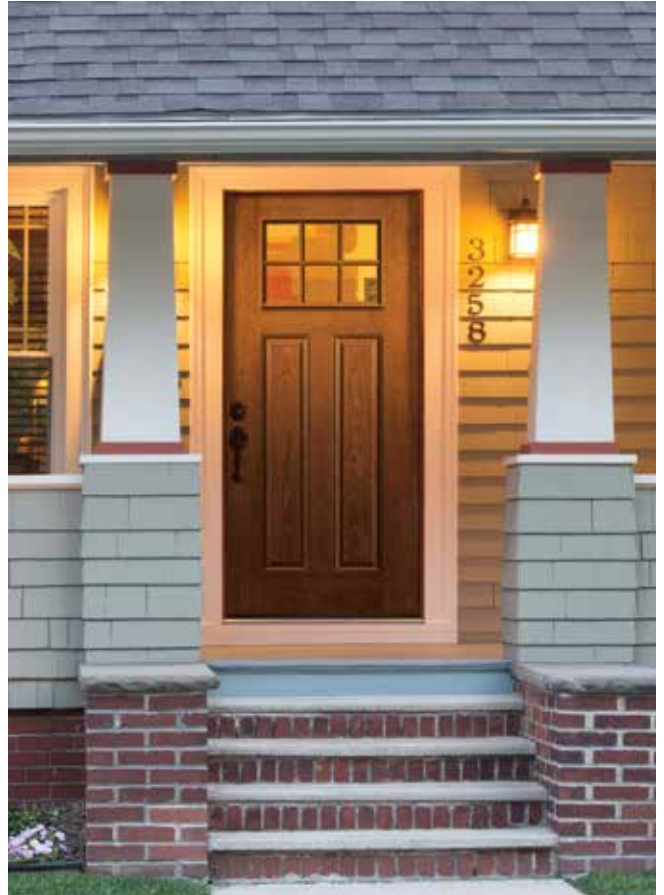

### SDL Bar Options



### GBG Bar Options

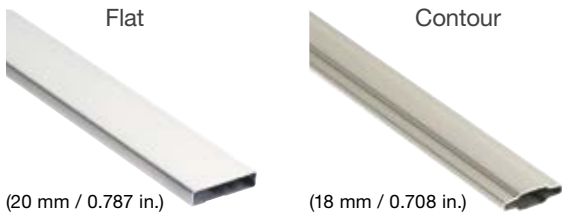

### GBG Color Options

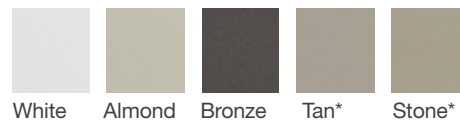

### Key

- Simulated Divided Lites (SDL)\*\*
- Simulated Divided Lites (SDLF1)\*\*
- Simulated Divided Lites (SDLF2)\*\*
- ◆ Flat White Grilles Between Glass Only (GBGFW)
- ◆ Flat or Contour, White or Color Grilles Between Glass (GBGF / GBGC)
- ▶ Removable Wood Grilles (RG)
- ◆ Fixed Grilles (FXG)



### Long-Term Performance

Glass built directly into the door during manufacturing offers long-term performance.

The **1** polyurethane foam core surrounds the glass, helping to provide durability and strength, and a **2** dual adhesive weather seal provides high-performance protection inside and out.

### Authentic Wood Door Appeal

Features true flush-glazed construction, crafted with attention to detail that replicates traditional wood door construction.

Available in privacy and textured glass, as well as divided lites, Low-E and clear glass. Look for the (🔥) icon.

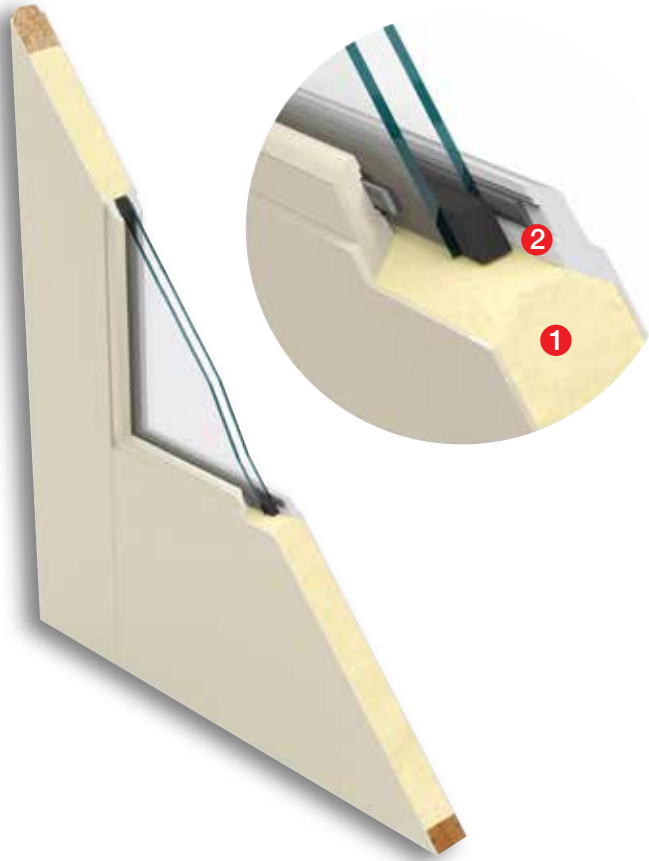

### Up to 16% wider daylight opening



Flush-Glazed Glass

Traditional Lip-Lite

### Wider Daylight Opening\*

Let in more natural light with up to a 16% increase in visible glass area.

### Seamless, Clean Lines

Factory-built, seamless construction eliminates the need for a lite frame and screw plugs.

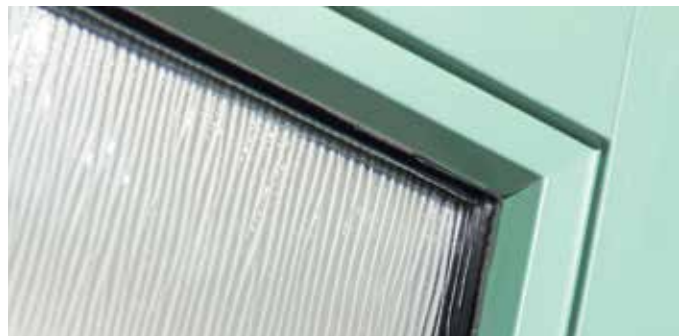

### Flush-Glazed Fiberglass Door Replacement Rider

Provides protection in case of accidental glass breakage during residential and multi-family construction or installation. Therma-Tru will replace the flush-glazed fiberglass door and sidelite.

\*Compared to conventional lite frames.

Note: See your Therma-Tru seller or visit [www.thermatru.com](http://www.thermatru.com) for details on limited warranties and exclusions, and Rider.

# Clavos & Strap Hinges

Add a finishing touch of rustic flavor with decorative hardware.

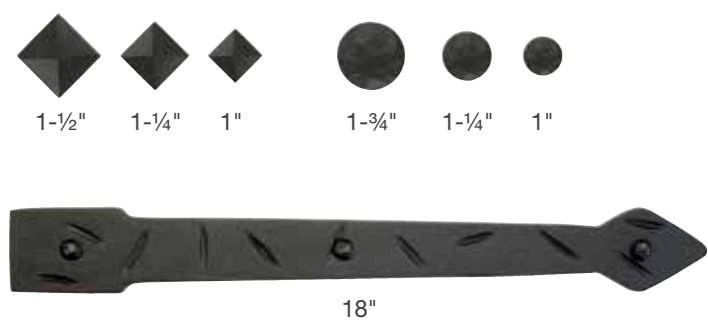

# Dentil Shelves

Complete the look with a dentil shelf for true Craftsman appeal.



Fiber-Classic. 4-Block Dentil Shelf\*\*



Smooth-Star. 4-Block Dentil Shelf\*\*



\*\*Not recommended for use behind storm doors or to be painted dark colors, if exposed to direct sunlight.

Bottom: Fiber-Classic Mahogany Collection, Chord Glass with SDLs, Door – FCM608XC, Sidelites – FCM6126XC SL, Dentil Shelf





Top: Smooth-Star, Clear Glass with GBGs, Door – S8321, Sidelites – S3487SL  
Bottom Left: Fiber-Classic Oak Collection, Avonlea Glass, Door – FC785, Sidelites – FC758SL, Transom – AVRT  
Bottom Right: Smooth-Star, Salinas Glass, Door – S81937P



# Blackstone®

## Fiber-Classic® Mahogany



|   |   |  |  |   |   |   |  |  |
|---|---|--|--|---|---|---|--|--|
| <b>FCM108</b><br>◆◆ 6<br>2'8" x 6'8"<br>2'10" x 6'8"<br>3'0" x 6'8" | <b>FCM871</b><br>◆◆ 6<br>2'8" x 8'0"<br>2'10" x 8'0"<br>3'0" x 8'0" | <b>FCM310</b><br>◆◆ 6<br>2'6" x 6'8" † ‡<br>2'8" x 6'8" † ‡<br>2'10" x 6'8" † ‡<br>3'0" x 6'8" † ‡ | <b>FCM816</b><br>◆◆ 6<br>2'6" x 8'0"<br>2'8" x 8'0"<br>2'10" x 8'0"<br>3'0" x 8'0" | <b>FCM765</b><br>◆◆ 6<br>2'8" x 6'8"<br>2'10" x 6'8"<br>3'0" x 6'8" | <b>FCM109</b><br>◆◆ 6<br>2'8" x 6'8"<br>2'10" x 6'8"<br>3'0" x 6'8" | <b>FCM863</b><br>◆◆ 6<br>2'8" x 8'0"<br>2'10" x 8'0"<br>3'0" x 8'0" | <b>FCM6032</b><br>◆◆ 6<br>2'8" x 6'8"<br>2'10" x 6'8"<br>3'0" x 6'8" | <b>FCM6052</b><br>◆◆ 6<br>2'8" x 6'8"<br>2'10" x 6'8"<br>3'0" x 6'8" |
|---|---|--|--|---|---|---|--|--|



|   |   |   |   |   |   |   |   |   |   |
|---|---|---|---|---|---|---|---|---|---|
| <b>FCM110</b><br>◆◆<br>2'8" x 6'8"<br>2'10" x 6'8"<br>3'0" x 6'8" | <b>FCM164</b><br>◆◆<br>2'8" x 6'8"<br>2'10" x 6'8"<br>3'0" x 6'8" | <b>FCM760</b><br>◆◆<br>2'8" x 6'8"<br>2'10" x 6'8"<br>3'0" x 6'8" | <b>FCM808SL</b><br>◆◆ 6<br>10" x 6'8"<br>12" x 6'8" † ‡<br>14" x 6'8" † ‡ | <b>FCM81918SL</b><br>◆◆ 6<br>12" x 8'0"<br>14" x 8'0" | <b>FCM871SL</b><br>◆◆ 6<br>12" x 8'0"<br>14" x 8'0" | <b>FCM765SL</b><br>◆◆ 6<br>12" x 6'8"<br>14" x 6'8" | <b>FCM882SL</b><br>◆◆ 6<br>12" x 8'0"<br>14" x 8'0" | <b>FCM109SL</b><br>◆◆ 6<br>12" x 6'8"<br>14" x 6'8" | <b>FCM863SL</b><br>◆◆ 6<br>12" x 8'0"<br>14" x 8'0" |
|---|---|---|---|---|---|---|---|---|---|

## Fiber-Classic® Oak



|   |   |   |   |  |  |   |   |   |
|---|---|---|---|--|--|---|---|---|
| <b>FC108</b><br>◆◆ 6<br>2'6" x 6'8"<br>2'8" x 6'8" †<br>2'10" x 6'8" †<br>3'0" x 6'8" † | <b>81918P</b><br>◆◆ 6<br>2'8" x 8'0"<br>2'10" x 8'0"<br>3'0" x 8'0" | <b>FC310</b><br>◆◆ 6<br>2'6" x 6'8" † ‡<br>2'8" x 6'8" † ‡<br>2'10" x 6'8" † ‡<br>3'0" x 6'8" † ‡ | <b>FC816</b><br>◆◆ 6<br>2'6" x 8'0"<br>2'8" x 8'0"<br>2'10" x 8'0"<br>3'0" x 8'0" | <b>FC765</b><br>◆◆ 6<br>2'8" x 6'8"<br>2'10" x 6'8"<br>3'0" x 6'8" | <b>FC770</b><br>◆◆ 6<br>2'8" x 6'8"<br>2'10" x 6'8"<br>3'0" x 6'8" | <b>81952P</b><br>◆◆ 6<br>2'8" x 8'0"<br>2'10" x 8'0"<br>3'0" x 8'0" | <b>FC109</b><br>◆◆ 6<br>2'6" x 6'8"<br>2'8" x 6'8" †<br>2'10" x 6'8" †<br>3'0" x 6'8" † | <b>81933P</b><br>◆◆ 6<br>2'8" x 8'0"<br>2'10" x 8'0"<br>3'0" x 8'0" |
|---|---|---|---|--|--|---|---|---|

**Blackstone Glass** Continues on next page.

### Key

- No Stile Lines
- ◆ Black Nickel Caming (1D)
- ◆◆ Brushed Nickel Caming (1C)
- Vented Sidelite (No Impact)  
(6'6" & 6'8" only in 12" & 14")
- 6 WBDR Options
- 6 WBDR / HVHZ Options
- △ 6'6" Height Available  
(8'0" only in 14")
- ‡ 7'0" Height Available

## Blackstone® Glass *Continued*



**81975P**  
 ◆ ◆ 6  
 2'8" x 8'0"  
 2'10" x 8'0"  
 3'0" x 8'0"



**FC129**  
 ◆ ◆ ◆  
 2'8" x 6'8"  
 2'10" x 6'8"  
 3'0" x 6'8"



**FC714**  
 ◆ ◆ ◆  
 2'8" x 6'8"  
 2'10" x 6'8"  
 3'0" x 6'8"



**FC164**  
 ◆ ◆ ◆  
 2'8" x 6'8"  
 2'10" x 6'8"  
 3'0" x 6'8"



**FC794**  
 ◆ ◆ ◆  
 2'8" x 6'8"  
 2'10" x 6'8"  
 3'0" x 6'8"



**FC801**  
 ◆ ◆ ◆  
 2'8" x 6'8"  
 2'10" x 6'8"  
 3'0" x 6'8"



**FC80943**  
 ◆ ◆ 6  
 2'8" x 6'8"  
 2'10" x 6'8"  
 3'0" x 6'8"



**FC86243**  
 ◆ ◆ ◆ 6  
 2'8" x 8'0"  
 2'10" x 8'0"  
 3'0" x 8'0"

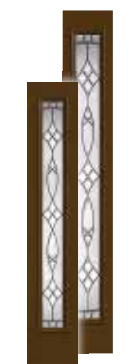

**FC108SL**  
 ◆ ◆ 6  
 10" x 6'8"  
 12" x 6'8"  
 14" x 6'8"



**81918PSL**  
 ◆ ◆ ◆ 6  
 12" x 8'0"  
 14" x 8'0"



**FC808SL**  
 ◆ ◆ ◆ 6  
 12" x 6'8" Δ ‡  
 14" x 6'8" Δ ‡



**81918SL**  
 ◆ ◆ ◆ 6  
 12" x 8'0"  
 14" x 8'0"



**FC765SL**  
 ◆ ◆ ◆ 6  
 12" x 6'8"  
 14" x 6'8"



**81952PSL**  
 ◆ ◆ ◆ 6  
 12" x 8'0"  
 14" x 8'0"



**FC109SL**  
 ◆ ◆ ◆ 6  
 12" x 6'8"  
 14" x 6'8"



**81933PSL**  
 ◆ ◆ ◆ 6  
 12" x 8'0"  
 14" x 8'0"

## Smooth-Star®



**S6002**  
 ◆ ◆ 6  
 2'6" x 6'8" Δ ‡  
 2'8" x 6'8" Δ ‡  
 2'10" x 6'8" Δ ‡  
 3'0" x 6'8" Δ ‡

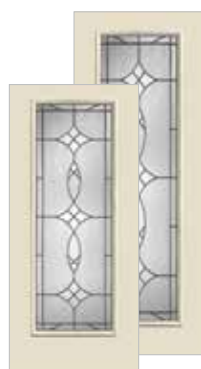

**S85892**  
 ◆ ◆ ◆ 6  
 2'6" x 8'0"  
 2'8" x 8'0"  
 2'10" x 8'0"  
 3'0" x 8'0"



**S310**  
 ◆ ◆ ◆ 6  
 2'6" x 6'8" Δ ‡  
 2'8" x 6'8" Δ ‡  
 2'10" x 6'8" Δ ‡  
 3'0" x 6'8" Δ ‡  
 3'6" x 6'8"



**S816**  
 ◆ ◆ ◆ 6  
 2'6" x 8'0"  
 2'8" x 8'0"  
 2'10" x 8'0"  
 3'0" x 8'0"  
 3'6" x 8'0"



**S975**  
 ◆ ◆ ◆ 6  
 2'8" x 6'8"  
 2'10" x 6'8"  
 3'0" x 6'8"



**S979**  
 ◆ ◆ ◆ 6  
 2'8" x 6'8"  
 2'10" x 6'8"  
 3'0" x 6'8"



**S894**  
 ◆ ◆ ◆ 6  
 2'8" x 8'0"  
 2'10" x 8'0"  
 3'0" x 8'0"



**S6000**  
 ◆ ◆ ◆ 6  
 2'6" x 6'8" ‡  
 2'8" x 6'8" ‡  
 2'10" x 6'8" ‡  
 3'0" x 6'8" ‡



**S81933P**  
 ◆ ◆ ◆ 6  
 2'8" x 8'0"  
 2'10" x 8'0"  
 3'0" x 8'0"



**S6032**  
 ◆ ◆ ◆ 6  
 2'6" x 6'8" ‡  
 2'8" x 6'8" ‡  
 2'10" x 6'8" ‡  
 3'0" x 6'8" ‡



**S6052**  
 ◆ ◆ ◆ 6  
 2'8" x 6'8"  
 2'10" x 6'8"  
 3'0" x 6'8"

**S972**  
 ◆ ◆ ◆ 6  
 2'8" x 6'8"  
 2'10" x 6'8"  
 3'0" x 6'8"

**S85905**  
 ◆ ◆ ◆ 6  
 2'8" x 8'0"  
 2'10" x 8'0"  
 3'0" x 8'0"

**S6013**  
 ◆ ◆ ◆  
 2'8" x 6'8"  
 2'10" x 6'8"  
 3'0" x 6'8"

**S771**  
 ◆ ◆ ◆  
 2'8" x 6'8"  
 2'10" x 6'8"  
 3'0" x 6'8"

**S6085**  
 ◆ ◆ ◆  
 2'8" x 6'8"  
 2'10" x 6'8"  
 3'0" x 6'8"

**S997**  
 ◆ ◆ ◆  
 2'8" x 6'8"  
 2'10" x 6'8"  
 3'0" x 6'8"

**S6111**  
 ◆ ◆ ◆  
 2'8" x 6'8"  
 2'10" x 6'8"  
 3'0" x 6'8"

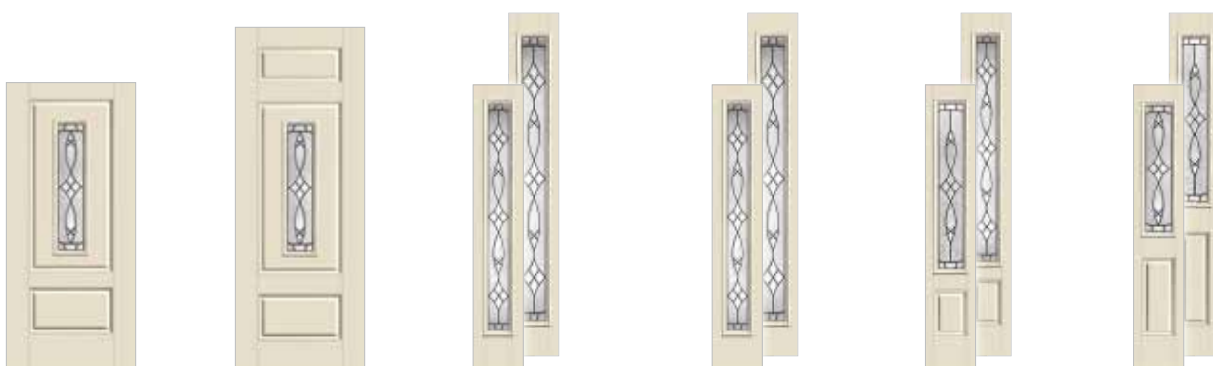

**S9343**  
 ◆ ◆ ◆ 6  
 2'8" x 6'8"  
 2'10" x 6'8"  
 3'0" x 6'8"

**S83143**  
 ◆ ◆ ◆ 6  
 2'8" x 8'0"  
 2'10" x 8'0"  
 3'0" x 8'0"

**S6002SL**  
 ◆ ◆ ◆ 6  
 12" x 6'8"  
 14" x 6'8"

**S85892SL**  
 ◆ ◆ ◆ 6  
 12" x 8'0"  
 14" x 8'0"

**S4570SL**  
 ◆ ◆ ◆ 6  
 10" x 6'8"  
 12" x 6'8" ⚠ ‡  
 14" x 6'8" ⚠ ‡

**S85927SL**  
 ◆ ◆ ◆ 6  
 12" x 8'0"  
 14" x 8'0"

**S975SL**  
 ◆ ◆ ◆ 6  
 12" x 6'8"  
 14" x 6'8"

**S894SL**  
 ◆ ◆ ◆ 6  
 12" x 8'0"  
 14" x 8'0"

**S6000SL**  
 ◆ ◆ ◆ 6  
 12" x 6'8"  
 14" x 6'8"

**S85912SL**  
 ◆ ◆ ◆ 6  
 12" x 8'0"  
 14" x 8'0"

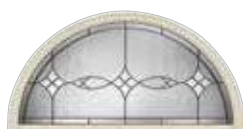

**BSHRT**  
 ◆ ◆ ◆  
 3'0" door + (2) 12" sidelites  
 3'0" door + (2) 14" sidelites  
 Continuous / Boxed Sill Systems



**BSRT**  
 ◆ ◆ ◆  
 3'0" door + (2) 12" sidelites  
 Continuous Sill Systems Only  
 Transoms can be stained or painted to match a Fiber-Classic or Smooth-Star door system.

**Key**

- No Stile Lines
- ◆ Black Nickel Caming (1D)
- ◆◆ Brushed Nickel Caming (1C)
- Vented Sidelite (No Impact)  
 (6'6" & 6'8" only in 12" & 14")  
 (8'0" only in 14")
- ⚡ WBDR Options
- ⚠ 6'6" Height Available
- ‡ 7'0" Height Available





# Crystalline™

## Fiber-Classic® Mahogany



|  |  |  |  |  |  |   |  |  |
|--|--|--|--|--|--|---|--|--|
| <b>FCM16</b><br>◆◆◆◆◆◆<br>2'8" x 6'8"<br>2'10" x 6'8"<br>3'0" x 6'8" | <b>FCM8114</b><br>◆◆◆◆◆◆<br>2'8" x 8'0"<br>2'10" x 8'0"<br>3'0" x 8'0" | <b>FCM668</b><br>◆◆◆◆◆◆<br>2'6" x 6'8" Δ ‡<br>2'8" x 6'8" Δ ‡<br>2'10" x 6'8" Δ ‡<br>3'0" x 6'8" Δ ‡ | <b>FCM814</b><br>◆◆◆◆◆◆<br>2'6" x 8'0"<br>2'8" x 8'0"<br>2'10" x 8'0"<br>3'0" x 8'0" | <b>FCM38</b><br>◆◆◆◆◆◆<br>2'8" x 6'8"<br>2'10" x 6'8"<br>3'0" x 6'8" | <b>FCM45</b><br>◆◆◆◆◆◆<br>2'8" x 6'8"<br>2'10" x 6'8"<br>3'0" x 6'8" | <b>FCM898</b><br>◆◆◆◆◆◆<br>2'8" x 8'0"<br>2'10" x 8'0"<br>3'0" x 8'0" | <b>FCM6027</b><br>◆◆◆◆◆◆<br>2'8" x 6'8"<br>2'10" x 6'8"<br>3'0" x 6'8" | <b>FCM6047</b><br>◆◆◆◆◆◆<br>2'8" x 6'8"<br>2'10" x 6'8"<br>3'0" x 6'8" |
|--|--|--|--|--|--|---|--|--|

Note: See page 273 for important product details that may help with your purchase decision.

Top: Fiber-Classic Oak Collection, Crystalline Glass, Door – FC16, Sidelites – FC46SL, Transom – 19820T



|  |  |  |  |  |  |  |   |  |   |
|--|--|--|--|--|--|--|---|--|---|
| <b>FCM124</b><br>◆◆◆<br>2'8" x 6'8"<br>2'10" x 6'8"<br>3'0" x 6'8" | <b>FCM802</b><br>◆◆◆<br>2'8" x 6'8"<br>2'10" x 6'8"<br>3'0" x 6'8" | <b>FCM18101SL</b><br>◆◆◆◆◆<br>10" x 6'8" †<br>12" x 6'8" †<br>14" x 6'8" † | <b>FCM81800SL</b><br>◆◆◆◆◆<br>12" x 8'0"<br>14" x 8'0" | <b>FCM8114SL</b><br>◆◆◆◆<br>12" x 8'0"<br>14" x 8'0" | <b>FCM38SL</b><br>◆◆◆◆<br>12" x 6'8"<br>14" x 6'8" | <b>FCM8105SL</b><br>◆◆◆◆<br>12" x 8'0"<br>14" x 8'0" | <b>FCM707SL</b><br>◆◆◆◆<br>12" x 6'8"<br>14" x 6'8" | <b>FCM45SL</b><br>◆◆◆◆<br>12" x 6'8"<br>14" x 6'8" | <b>FCM898SL</b><br>◆◆◆◆<br>12" x 8'0"<br>14" x 8'0" |
|--|--|--|--|--|--|--|---|--|---|

## Fiber-Classic® Oak



|  |   |  |  |   |  |   |  |   |   |
|--|---|--|--|---|--|---|--|---|---|
| <b>FC16</b><br>◆◆◆◆<br>2'6" x 6'8"<br>2'8" x 6'8" †<br>2'10" x 6'8" †<br>3'0" x 6'8" † | <b>81800P</b><br>◆◆◆◆<br>2'8" x 8'0"<br>2'10" x 8'0"<br>3'0" x 8'0" | <b>FC668</b><br>◆◆◆◆◆<br>2'6" x 6'8" †<br>2'8" x 6'8" †<br>2'10" x 6'8" †<br>3'0" x 6'8" † | <b>FC814</b><br>◆◆◆◆◆<br>2'6" x 8'0"<br>2'8" x 8'0"<br>2'10" x 8'0"<br>3'0" x 8'0" | <b>FC38</b><br>◆◆◆◆<br>2'8" x 6'8"<br>2'10" x 6'8"<br>3'0" x 6'8" | <b>FC772</b><br>◆◆◆◆<br>2'8" x 6'8"<br>2'10" x 6'8"<br>3'0" x 6'8" | <b>81953P</b><br>◆◆◆◆<br>2'8" x 8'0"<br>2'10" x 8'0"<br>3'0" x 8'0" | <b>FC45</b><br>◆◆◆◆<br>2'6" x 6'8"<br>2'8" x 6'8" †<br>2'10" x 6'8" †<br>3'0" x 6'8" † | <b>81935P</b><br>◆◆◆◆<br>2'8" x 8'0"<br>2'10" x 8'0"<br>3'0" x 8'0" | <b>81977P</b><br>◆◆◆◆<br>2'8" x 8'0"<br>2'10" x 8'0"<br>3'0" x 8'0" |
|--|---|--|--|---|--|---|--|---|---|



|   |  |   |   |  |   |  |  |
|---|--|---|---|--|---|--|--|
| <b>FC43</b><br>◆◆◆◆<br>2'8" x 6'8"<br>2'10" x 6'8"<br>3'0" x 6'8" | <b>FC124</b><br>◆◆◆◆<br>2'8" x 6'8"<br>2'10" x 6'8"<br>3'0" x 6'8" | <b>FC80941</b><br>◆◆◆◆◆<br>2'8" x 6'8"<br>2'10" x 6'8"<br>3'0" x 6'8" | <b>FC86241</b><br>◆◆◆◆◆<br>2'8" x 8'0"<br>2'10" x 8'0"<br>3'0" x 8'0" | <b>FC21</b><br>◆◆◆◆<br>2'6" x 6'8"<br>2'8" x 6'8"<br>2'10" x 6'8"<br>3'0" x 6'8" | <b>FC802</b><br>◆◆◆◆<br>2'6" x 6'8" †<br>2'8" x 6'8" †<br>2'10" x 6'8" †<br>3'0" x 6'8" † | <b>FC46SL</b><br>◆◆◆◆◆<br>10" x 6'8"<br>12" x 6'8"<br>14" x 6'8" | <b>81800PSL</b><br>◆◆◆◆◆<br>12" x 8'0"<br>14" x 8'0" |
|---|--|---|---|--|---|--|--|

Crystalline Glass *Continues on next page.*

### Key

- No Stile Lines
- ◆ Black Nickel Caming (1D)
- Brushed Nickel Caming (1C)
- ◆ Brass Caming (1A)
- Vented Sidelite (No Impact)  
(6'6" & 6'8" only in 12" & 14")  
(8'0" only in 14")
- ⬆ 6'6" Height Available
- ⬆ 7'0" Height Available
- 6 WBDR Options
- 6 WBDR / HVHZ Options

## Smooth-Star®



**18101SL**  
 12" x 6'8" Δ ‡  
 14" x 6'8" Δ ‡



**81800SL**  
 12" x 8'0"  
 14" x 8'0"

**FC38SL**  
 12" x 6'8"  
 14" x 6'8"

**81953PSL**  
 12" x 8'0"  
 14" x 8'0"



**FC707SL**  
 12" x 6'8"  
 14" x 6'8"



**FC43SL**  
 12" x 6'8"  
 14" x 6'8"

**81935PSL**  
 12" x 8'0"  
 14" x 8'0"



**S916**  
 2'6" x 6'8" Δ ‡  
 2'8" x 6'8" Δ ‡  
 2'10" x 6'8" Δ ‡  
 3'0" x 6'8" Δ ‡



**S814**  
 2'6" x 8'0"  
 2'8" x 8'0"  
 2'10" x 8'0"  
 3'0" x 8'0"



**S668**  
 2'6" x 6'8" Δ ‡  
 2'8" x 6'8" Δ ‡  
 2'10" x 6'8" Δ ‡  
 3'0" x 6'8" Δ ‡  
 3'6" x 6'8"



**S815**  
 2'6" x 8'0"  
 2'8" x 8'0"  
 2'10" x 8'0"  
 3'0" x 8'0"  
 3'6" x 8'0"

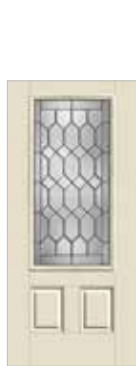

**S977**  
 2'8" x 6'8"  
 2'10" x 6'8"  
 3'0" x 6'8"



**S981**  
 2'8" x 6'8"  
 2'10" x 6'8"  
 3'0" x 6'8"



**S888**  
 2'8" x 8'0"  
 2'10" x 8'0"  
 3'0" x 8'0"



**S926**  
 2'6" x 6'8"  
 2'8" x 6'8" ‡  
 2'10" x 6'8" ‡  
 3'0" x 6'8" ‡



**S81935P**  
 2'8" x 8'0"  
 2'10" x 8'0"  
 3'0" x 8'0"



**S6027**  
 2'6" x 6'8"  
 2'8" x 6'8" ‡  
 2'10" x 6'8" ‡  
 3'0" x 6'8" ‡



**S6047**  
 2'8" x 6'8"  
 2'10" x 6'8"  
 3'0" x 6'8"



**S38**  
 2'8" x 6'8"  
 2'10" x 6'8"  
 3'0" x 6'8"



**S85907**  
 2'8" x 8'0"  
 2'10" x 8'0"  
 3'0" x 8'0"



**S950**  
 2'8" x 6'8"  
 2'10" x 6'8"  
 3'0" x 6'8"



**S930**  
 2'8" x 6'8"  
 2'10" x 6'8"  
 3'0" x 6'8"



**S6113**  
 2'8" x 6'8"  
 2'10" x 6'8"  
 3'0" x 6'8"



**S9341**  
 2'8" x 6'8"  
 2'10" x 6'8"  
 3'0" x 6'8"



**S83141**  
 2'8" x 8'0"  
 2'10" x 8'0"  
 3'0" x 8'0"



**S6123**  
 2'8" x 6'8"  
 2'10" x 6'8"  
 3'0" x 6'8"



**S936**  
 2'6" x 6'8"  
 2'8" x 6'8" ‡  
 2'10" x 6'8" ‡  
 3'0" x 6'8" ‡



**S916SL**  
 12" x 6'8"  
 14" x 6'8"

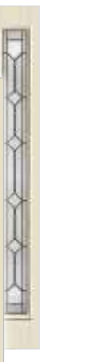

**S814SL**  
 12" x 8'0"  
 14" x 8'0"

\*Not recommended for use behind storm doors or to be painted dark colors, if exposed to direct sunlight.  
 Note: See page 273 for important product details that may help with your purchase decision.



**S6130SL**  
 ■ ◆ ◆ ◆ ◆ ◆  
 ● 6  
 10" x 6'8"  
 12" x 6'8" ▲ †  
 14" x 6'8" ▲ †

**S84586SL**  
 ■ ◆ ◆ ◆ ◆ ◆  
 ● 6  
 12" x 8'0"  
 14" x 8'0"

**S758SL**  
 ■ ◆ ◆ ◆ ◆ ◆  
 ● 6  
 12" x 6'8"  
 14" x 6'8"

**S888SL**  
 ■ ◆ ◆ ◆ ◆ ◆  
 ● 6  
 12" x 8'0"  
 14" x 8'0"

**S768SL**  
 ■ ◆ ◆ ◆ ◆ ◆  
 12" x 6'8"  
 14" x 6'8"

**S930SL**  
 ■ ◆ ◆ ◆ ◆ ◆  
 ● 6  
 12" x 6'8"  
 14" x 6'8"

**S85914SL**  
 ■ ◆ ◆ ◆ ◆ ◆  
 ● 6  
 12" x 8'0"  
 14" x 8'0"

**S950SL**  
 ■ ◆ ◆ ◆ ◆ ◆  
 12" x 6'8"  
 14" x 6'8"



**BLHRT** ◆ ◆ ◆ ◆ ◆ ◆  
 3'0" door + (2) 12" sidelites  
 3'0" door + (2) 14" sidelites  
 Continuous / Boxed Sill Systems



**19810T** ◆ ◆ ◆ ◆ ◆ ◆  
 12" & 14" Sidelite Only



**19800T** ◆ ◆ ◆ ◆ ◆ ◆  
 3'0" Door Only



**19080T** ◆ ◆ ◆ ◆ ◆ ◆  
 3'0" door + (2) 12" sidelites  
 Continuous Sill Systems Only  
 3'0" door + (2) 14" sidelites  
 Continuous / Boxed Sill Systems



**19820T** ◆ ◆ ◆ ◆ ◆ ◆  
 3'0" door + (2) 12" sidelites  
 3'0" door + (2) 14" sidelites  
 Continuous / Boxed Sill Systems

Transoms can be stained or painted to match a Fiber-Classic or Smooth-Star door system.

# Sedona

Note: Shown in art glass with black nickel caming.

## Fiber-Classic® Mahogany



**FCM100-A**  
 ▶  
**FCM100**  
 ◆ ◆ ◆ ◆ ◆ ◆  
 2'8" x 6'8"  
 2'10" x 6'8"  
 3'0" x 6'8"

**FCM872-A**  
 ▶  
**FCM872**  
 ◆ ◆ ◆ ◆ ◆ ◆  
 2'8" x 8'0"  
 2'10" x 8'0"  
 3'0" x 8'0"

**FCM241-A**  
 ▶  
**FCM241**  
 ■ ◆ ◆ ◆ ◆ ◆  
 2'6" x 6'8" ▲ †  
 2'8" x 6'8" ▲ †  
 2'10" x 6'8" ▲ †  
 3'0" x 6'8" ▲ †

**FCM822-A**  
 ▶  
**FCM822**  
 ■ ◆ ◆ ◆ ◆ ◆  
 2'8" x 8'0"  
 2'10" x 8'0"  
 3'0" x 8'0"

**FCM131-A**  
 ▶  
**FCM131**  
 ◆ ◆ ◆ ◆ ◆ ◆  
 2'8" x 6'8"  
 2'10" x 6'8"  
 3'0" x 6'8"

**FCM101-A**  
 ▶  
**FCM101**  
 ◆ ◆ ◆ ◆ ◆ ◆  
 2'8" x 6'8"  
 2'10" x 6'8"  
 3'0" x 6'8"

**FCM864-A**  
 ▶  
**FCM864**  
 ◆ ◆ ◆ ◆ ◆ ◆  
 2'8" x 8'0"  
 2'10" x 8'0"  
 3'0" x 8'0"

**FCM6025-A**  
 ▶  
**FCM6025**  
 ◆ ◆ ◆ ◆ ◆ ◆  
 2'8" x 6'8"  
 2'10" x 6'8"  
 3'0" x 6'8"

**FCM6045-A**  
 ▶  
**FCM6045**  
 ◆ ◆ ◆ ◆ ◆ ◆  
 2'8" x 6'8"  
 2'10" x 6'8"  
 3'0" x 6'8"

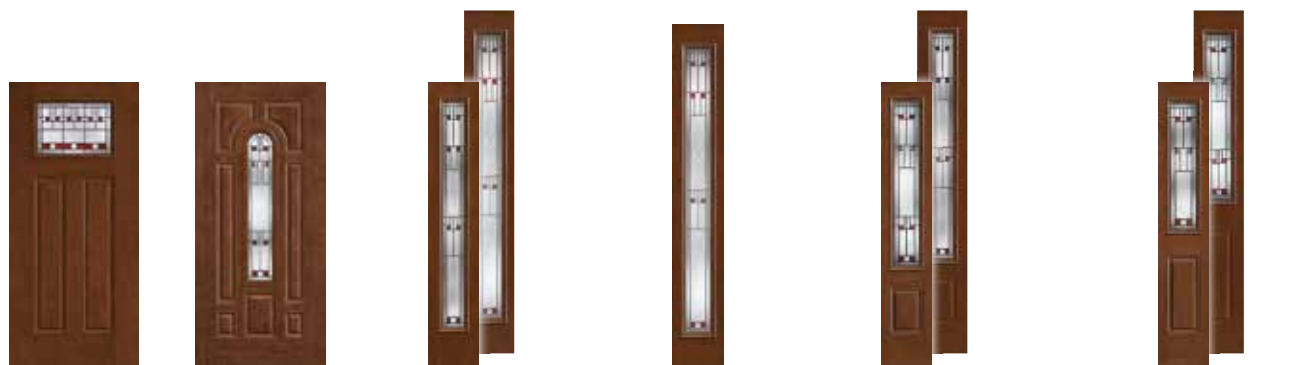

**FCM604-A**  
 ▶  
**FCM604**  
 ◆ ◆ ◆ ◆ ◆ ◆  
 2'8" x 6'8"  
 2'10" x 6'8"  
 3'0" x 6'8"

**FCM126-A**  
 ▶  
**FCM126**  
 ◆ ◆ ◆ ◆ ◆ ◆  
 2'8" x 6'8"  
 2'10" x 6'8"  
 3'0" x 6'8"

**FCM816SL-A**  
 ▶  
**FCM816SL**  
 ■ ◆ ◆ ◆ ◆ ◆  
 10" x 6'8"  
 12" x 6'8" ▲ †  
 14" x 6'8" ▲ †

**FCM81968SL-A**  
 ▶  
**FCM81968SL**  
 ■ ◆ ◆ ◆ ◆ ◆  
 12" x 8'0"  
 14" x 8'0"

**FCM872SL-A**  
 ▶  
**FCM872SL**  
 ◆ ◆ ◆ ◆ ◆ ◆  
 12" x 8'0"  
 14" x 8'0"

**FCM131SL-A**  
 ▶  
**FCM131SL**  
 ◆ ◆ ◆ ◆ ◆ ◆  
 12" x 6'8"  
 14" x 6'8"

**FCM883SL-A**  
 ▶  
**FCM883SL**  
 ◆ ◆ ◆ ◆ ◆ ◆  
 12" x 8'0"  
 14" x 8'0"

**FCM101SL-A**  
 ▶  
**FCM101SL**  
 ◆ ◆ ◆ ◆ ◆ ◆  
 12" x 6'8"  
 14" x 6'8"

**FCM864SL-A**  
 ▶  
**FCM864SL**  
 ◆ ◆ ◆ ◆ ◆ ◆  
 12" x 8'0"  
 14" x 8'0"

Sedona Glass Continues on next page.

### Key

- No Stile Lines
- ▶ Art Glass / Black Nickel Caming (1D)
- ◆ Black Nickel Caming (1D)
- Brushed Nickel Caming (1C)
- ◆ Brass Caming (1A)
- Vented Sidelite (No Impact)  
(6'6" & 6'8" only in 12" & 14")  
 (8'0" only in 14")
- 6 WBDR Options
- 6 WBDR / HVHZ Options
- ▲ 6'6" Height Available
- † 7'0" Height Available

### Optional Dentil Shelf\*



**4-Block Dentil Shelf**  
 Available for all Craftsman-style  
 Fiber-Classic Mahogany Collection doors.

# Fiber-Classic® Oak



**FC100-A**  
▶  
**FC100**  
◆ ◆  
2'6" x 6'8"  
2'8" x 6'8" ‡  
2'10" x 6'8" ‡  
3'0" x 6'8" ‡



**81968P-A**  
▶  
**81968P**  
◆ ◆  
2'8" x 8'0"  
2'10" x 8'0"  
3'0" x 8'0"



**FC241-A**  
▶▶  
**FC241**  
◆ ◆ ◆ ◆  
2'6" x 6'8" ‡ ‡  
2'8" x 6'8" ‡ ‡  
2'10" x 6'8" ‡ ‡  
3'0" x 6'8" ‡ ‡



**FC822-A**  
▶▶  
**FC822**  
◆ ◆ ◆ ◆  
2'8" x 8'0"  
2'10" x 8'0"  
3'0" x 8'0"



**FC131-A**  
▶  
**FC131**  
◆ ◆  
2'8" x 6'8"  
2'10" x 6'8"  
3'0" x 6'8"



**FC773-A**  
▶  
**FC773**  
◆ ◆  
2'8" x 6'8"  
2'10" x 6'8"  
3'0" x 6'8"



**81954P-A**  
▶  
**81954P**  
◆ ◆  
2'8" x 8'0"  
2'10" x 8'0"  
3'0" x 8'0"



**FC101-A**  
▶  
**FC101**  
◆ ◆  
2'6" x 6'8"  
2'8" x 6'8" ‡  
2'10" x 6'8" ‡  
3'0" x 6'8" ‡



**81936P-A**  
▶  
**81936P**  
◆ ◆  
2'8" x 8'0"  
2'10" x 8'0"  
3'0" x 8'0"



**81978P-A**  
▶  
**81978P**  
◆ ◆  
2'8" x 8'0"  
2'10" x 8'0"  
3'0" x 8'0"



**FC128-A**  
▶  
**FC128**  
◆ ◆  
2'8" x 6'8"  
2'10" x 6'8"  
3'0" x 6'8"



**FC126-A**  
▶  
**FC126**  
◆ ◆  
2'8" x 6'8"  
2'10" x 6'8"  
3'0" x 6'8"



**FC80952-A**  
▶  
**FC80952**  
◆ ◆  
2'8" x 6'8"  
2'10" x 6'8"  
3'0" x 6'8"



**FC86252-A**  
▶  
**FC86252**  
◆ ◆  
2'8" x 8'0"  
2'10" x 8'0"  
3'0" x 8'0"



**FC100SL-A**  
▶  
**FC100SL**  
◆ ◆  
10" x 6'8"  
12" x 6'8"  
14" x 6'8"



**81968PSL-A**  
▶  
**81968PSL**  
◆ ◆  
12" x 8'0"  
14" x 8'0"



**FC816SL-A**  
▶▶  
**FC816SL**  
◆ ◆ ◆ ◆  
12" x 6'8" ‡ ‡  
14" x 6'8" ‡ ‡



**81968SL-A**  
▶▶  
**81968SL**  
◆ ◆ ◆ ◆  
12" x 8'0"  
14" x 8'0"



**FC131SL-A**  
▶  
**FC131SL**  
◆ ◆  
12" x 6'8"  
14" x 6'8"



**81954PSL-A**  
▶  
**81954PSL**  
◆ ◆  
12" x 8'0"  
14" x 8'0"

## Smooth-Star®



**S139-A**  
▶  
**S139**  
◆ ◆  
2'6" x 6'8" ‡  
2'8" x 6'8" ‡ ‡  
2'10" x 6'8" ‡ ‡  
3'0" x 6'8" ‡ ‡



**S241-A**  
▶  
**S241**  
◆ ◆ ◆ ◆  
2'6" x 6'8" ‡  
2'8" x 6'8" ‡ ‡  
2'10" x 6'8" ‡ ‡  
3'0" x 6'8" ‡ ‡  
3'6" x 6'8"

\*Not recommended for use behind storm doors or to be painted dark colors, if exposed to direct sunlight.  
Note: See page 273 for important product details that may help with your purchase decision.



|  |  |  |  |  |  |  |  |  |
|--|--|--|--|--|--|--|--|--|
| <p><b>S95-A</b><br/>▶<br/><b>S95</b><br/>◆ ■■<br/>2'8" x 6'8"<br/>2'10" x 6'8"<br/>3'0" x 6'8"</p> | <p><b>S91-A</b><br/>▶<br/><b>S91</b><br/>◆ ■■<br/>2'8" x 6'8"<br/>2'10" x 6'8"<br/>3'0" x 6'8"</p> | <p><b>S887-A</b><br/>▶<br/><b>S887</b><br/>◆ ■■<br/>2'8" x 8'0"<br/>2'10" x 8'0"<br/>3'0" x 8'0"</p> | <p><b>S211-A</b><br/>▶<br/><b>S211</b><br/>◆ ■■<br/>2'6" x 6'8"<br/>2'8" x 6'8" ‡<br/>2'10" x 6'8" ‡<br/>3'0" x 6'8" ‡</p> | <p><b>S81936P-A</b><br/>▶<br/><b>S81936P</b><br/>◆ ■■<br/>2'8" x 8'0"<br/>2'10" x 8'0"<br/>3'0" x 8'0"</p> | <p><b>S6025-A</b><br/>▶<br/><b>S6025</b><br/>◆ ■■<br/>2'6" x 6'8"<br/>2'8" x 6'8" ‡<br/>2'10" x 6'8" ‡<br/>3'0" x 6'8" ‡</p> | <p><b>S6045-A</b><br/>▶<br/><b>S6045</b><br/>◆ ■■<br/>2'8" x 6'8"<br/>2'10" x 6'8"<br/>3'0" x 6'8"</p> | <p><b>S35-A</b><br/>▶<br/><b>S35</b><br/>◆ ■■<br/>2'8" x 6'8"<br/>2'10" x 6'8"<br/>3'0" x 6'8"</p> | <p><b>S833-A</b><br/>▶<br/><b>S833</b><br/>◆ ■■<br/>2'8" x 8'0"<br/>2'10" x 8'0"<br/>3'0" x 8'0"</p> |
|--|--|--|--|--|--|--|--|--|



|  |  |  |  |  |  |   |   |
|--|--|--|--|--|--|---|---|
| <p><b>S294-A</b><br/>▶<br/><b>S294</b><br/>◆ ■■<br/>2'8" x 6'8"<br/>2'10" x 6'8"<br/>3'0" x 6'8"</p> | <p><b>S604-A</b><br/>▶<br/><b>S604</b><br/>◆ ■■<br/>2'8" x 6'8"<br/>2'10" x 6'8"<br/>3'0" x 6'8"</p> | <p><b>S8604-A</b><br/>▶<br/><b>S8604</b><br/>◆ ■■<br/>2'8" x 8'0"<br/>2'10" x 8'0"<br/>3'0" x 8'0"</p> | <p><b>S12-A</b><br/>▶<br/><b>S12</b><br/>◆ ■■<br/>2'8" x 6'8"<br/>2'10" x 6'8"<br/>3'0" x 6'8"</p> | <p><b>S9352-A</b><br/>▶<br/><b>S9352</b><br/>◆ ■■<br/>2'8" x 6'8"<br/>2'10" x 6'8"<br/>3'0" x 6'8"</p> | <p><b>S83152-A</b><br/>▶<br/><b>S83152</b><br/>◆ ■■<br/>2'8" x 8'0"<br/>2'10" x 8'0"<br/>3'0" x 8'0"</p> | <p><b>S139SL-A</b><br/>▶<br/><b>S139SL</b><br/>◆ ■■<br/>12" x 6'8"<br/>14" x 6'8"</p> | <p><b>S604SL-A</b><br/>▶ ▶ ●<br/><b>S604SL</b><br/>◆ ◆ ●<br/>10" x 6'8"<br/>12" x 6'8" † ‡<br/>14" x 6'8" † ‡</p> |
|--|--|--|--|--|--|---|---|



|   |   |   |   |
|---|---|---|---|
| <p><b>S91SL-A</b><br/>▶<br/><b>S91SL</b><br/>◆ ■■<br/>12" x 6'8"<br/>14" x 6'8"</p> | <p><b>S887SL-A</b><br/>▶<br/><b>S887SL</b><br/>◆ ■■<br/>12" x 8'0"<br/>14" x 8'0"</p> | <p><b>S294SL-A</b><br/>▶<br/><b>S294SL</b><br/>◆ ■■<br/>12" x 6'8"<br/>14" x 6'8"</p> | <p><b>S85915SL-A</b><br/>▶<br/><b>S85915SL</b><br/>◆ ■■<br/>12" x 8'0"<br/>14" x 8'0"</p> |
|---|---|---|---|



**19055T-A**  
▶  
**19055T**  
◆ ■■  
3'0" door + (2) 12" sidelites  
3'0" door + (2) 14" sidelites  
Continuous Sill Systems Only



**19520T-A**  
▶  
**19520T**  
◆ ■■  
3'0" door + (2) 12" sidelites  
3'0" door + (2) 14" sidelites  
Continuous Sill Systems Only

Transoms can be stained or painted to match a Fiber-Classic or Smooth-Star door system.

**Key**

- No Stile Lines
- ▶ Art Glass / Black Nickel Caming (1D)
- ◆ Black Nickel Caming (1D)
- ■■ Brushed Nickel Caming (1C)
- Vented Sidelite (No Impact)  
(6'6" & 6'8" only in 12" & 14")  
(8'0" only in 14")
- ▲ 6'6" Height Available
- ‡ 7'0" Height Available

**Optional Dentil Shelf\***

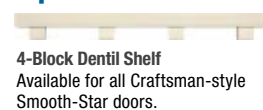



# Salinas®

## Fiber-Classic® Mahogany

Note: Product images show exterior side of door.



|   |   |  |  |   |   |   |  |  |  |
|---|---|--|--|---|---|---|--|--|--|
| <b>FCM113</b><br>X6<br>2'8" x 6'8"<br>2'10" x 6'8"<br>3'0" x 6'8" | <b>FCM873</b><br>X6<br>2'8" x 8'0"<br>2'10" x 8'0"<br>3'0" x 8'0" | <b>FCM369</b><br>X6<br>2'6" x 6'8" † ‡<br>2'8" x 6'8" † ‡<br>2'10" x 6'8" † ‡<br>3'0" x 6'8" † ‡ | <b>FCM817</b><br>X6<br>2'6" x 8'0"<br>2'8" x 8'0"<br>2'10" x 8'0"<br>3'0" x 8'0" | <b>FCM115</b><br>X6<br>2'8" x 6'8"<br>2'10" x 6'8"<br>3'0" x 6'8" | <b>FCM114</b><br>X6<br>2'8" x 6'8"<br>2'10" x 6'8"<br>3'0" x 6'8" | <b>FCM865</b><br>X6<br>2'8" x 8'0"<br>2'10" x 8'0"<br>3'0" x 8'0" | <b>FCM6031</b><br>X6<br>2'8" x 6'8"<br>2'10" x 6'8"<br>3'0" x 6'8" | <b>FCM6051</b><br>X6<br>2'8" x 6'8"<br>2'10" x 6'8"<br>3'0" x 6'8" | <b>FCM118</b><br>X<br>2'8" x 6'8"<br>2'10" x 6'8"<br>3'0" x 6'8" |
|---|---|--|--|---|---|---|--|--|--|

## Fiber-Classic® Oak



|   |   |   |   |   |   |   |   |   |   |   |
|---|---|---|---|---|---|---|---|---|---|---|
| <b>FCM814SL</b><br>X6<br>10" x 6'8"<br>12" x 6'8" † ‡<br>14" x 6'8" † ‡ | <b>FCM81919SL</b><br>X6<br>12" x 8'0"<br>14" x 8'0" | <b>FCM873SL</b><br>X6<br>12" x 8'0"<br>14" x 8'0" | <b>FCM115SL</b><br>X6<br>12" x 6'8"<br>14" x 6'8" | <b>FCM884SL</b><br>X6<br>12" x 8'0"<br>14" x 8'0" | <b>FCM114SL</b><br>X6<br>12" x 6'8"<br>14" x 6'8" | <b>FCM865SL</b><br>X6<br>12" x 8'0"<br>14" x 8'0" | <b>FC113</b><br>X6<br>2'6" x 6'8"<br>2'8" x 6'8" †<br>2'10" x 6'8" †<br>3'0" x 6'8" † | <b>81919P</b><br>X6<br>2'8" x 8'0"<br>2'10" x 8'0"<br>3'0" x 8'0" | <b>FC369</b><br>X6<br>2'6" x 6'8" † ‡<br>2'8" x 6'8" † ‡<br>2'10" x 6'8" † ‡<br>3'0" x 6'8" † ‡ | <b>FC817</b><br>X6<br>2'6" x 8'0"<br>2'8" x 8'0"<br>2'10" x 8'0"<br>3'0" x 8'0" |
|---|---|---|---|---|---|---|---|---|---|---|



|  |  |   |   |   |   |   |   |  |
|--|--|---|---|---|---|---|---|--|
| <b>FC115</b><br>X6<br>2'8" x 6'8"<br>2'10" x 6'8"<br>3'0" x 6'8" | <b>FC775</b><br>X6<br>2'8" x 6'8"<br>2'10" x 6'8"<br>3'0" x 6'8" | <b>81955P</b><br>X6<br>2'8" x 8'0"<br>2'10" x 8'0"<br>3'0" x 8'0" | <b>FC114</b><br>X6<br>2'6" x 6'8"<br>2'8" x 6'8" †<br>2'10" x 6'8" †<br>3'0" x 6'8" † | <b>81937P</b><br>X6<br>2'8" x 8'0"<br>2'10" x 8'0"<br>3'0" x 8'0" | <b>81980P</b><br>X6<br>2'8" x 8'0"<br>2'10" x 8'0"<br>3'0" x 8'0" | <b>FC130</b><br>X<br>2'8" x 6'8"<br>2'10" x 6'8"<br>3'0" x 6'8" | <b>FC118</b><br>X<br>2'8" x 6'8"<br>2'10" x 6'8"<br>3'0" x 6'8" | <b>FC80953</b><br>X6<br>2'8" x 6'8"<br>2'10" x 6'8"<br>3'0" x 6'8" |
|--|--|---|---|---|---|---|---|--|

Note: See page 273 for important product details that may help with your purchase decision.

Right Page: Fiber-Classic Mahogany Collection, Salinas Glass, Doors – FCM865



FC86253  
 X 6  
 2'8" x 8'0"  
 2'10" x 8'0"  
 3'0" x 8'0"



FC113SL 81919PSL  
 X 6 X 6  
 10" x 6'8" 12" x 8'0"  
 12" x 6'8" 14" x 8'0"  
 14" x 6'8"



FC814SL 81919SL  
 X 6 X 6  
 12" x 6'8" 12" x 8'0"  
 14" x 6'8" 14" x 8'0"  
 † † † †

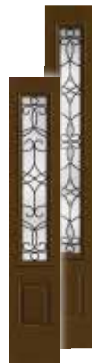

FC115SL 81955PSL  
 X 6 X 6  
 12" x 6'8" 12" x 8'0"  
 14" x 6'8" 14" x 8'0"



FC114SL 81937PSL  
 X 6 X 6  
 12" x 6'8" 12" x 8'0"  
 14" x 6'8" 14" x 8'0"



Salinas Glass *Continues on next page.*

**Key**

- No Stile Lines
- X Wrought Iron (1W)
- Vented Sidelite (No Impact)  
 (6'6" & 6'8" only in 12" & 14")  
 (8'0" only in 14")
- 6 WBDR Options
- 6 WBDR / HVHZ Options
- ⚠ 6'6" Height Available
- ‡ 7'0" Height Available

# Smooth-Star®



**S6008**  
**X6**  
 2'6" x 6'8" Δ  
 2'8" x 6'8" Δ ‡  
 2'10" x 6'8" Δ ‡  
 3'0" x 6'8" Δ ‡

**S85893**  
**X6**  
 2'6" x 8'0"  
 2'8" x 8'0"  
 2'10" x 8'0"  
 3'0" x 8'0"

**S369**  
**X6**  
 2'6" x 6'8" Δ ‡  
 2'8" x 6'8" Δ ‡  
 2'10" x 6'8" Δ ‡  
 3'0" x 6'8" Δ ‡  
 3'6" x 6'8"

**S817**  
**X6**  
 2'6" x 8'0"  
 2'8" x 8'0"  
 2'10" x 8'0"  
 3'0" x 8'0"  
 3'6" x 8'0"

**S6009**  
**X6**  
 2'8" x 6'8"  
 2'10" x 6'8"  
 3'0" x 6'8"

**S6010**  
**X6**  
 2'8" x 6'8"  
 2'10" x 6'8"  
 3'0" x 6'8"

**S895**  
**X6**  
 2'8" x 8'0"  
 2'10" x 8'0"  
 3'0" x 8'0"

**S6006**  
**X6**  
 2'6" x 6'8"  
 2'8" x 6'8" ‡  
 2'10" x 6'8" ‡  
 3'0" x 6'8" ‡

**S81937P**  
**X6**  
 2'8" x 8'0"  
 2'10" x 8'0"  
 3'0" x 8'0"

**S6031**  
**X6**  
 2'6" x 6'8"  
 2'8" x 6'8" ‡  
 2'10" x 6'8" ‡  
 3'0" x 6'8" ‡



**S6051**  
**X6**  
 2'8" x 6'8"  
 2'10" x 6'8"  
 3'0" x 6'8"

**S973**  
**X6**  
 2'8" x 6'8"  
 2'10" x 6'8"  
 3'0" x 6'8"

**S893**  
**X6**  
 2'8" x 8'0"  
 2'10" x 8'0"  
 3'0" x 8'0"

**S6011**  
**X**  
 2'8" x 6'8"  
 2'10" x 6'8"  
 3'0" x 6'8"

**S6014**  
**X**  
 2'8" x 6'8"  
 2'10" x 6'8"  
 3'0" x 6'8"

**S6012**  
**X**  
 2'8" x 6'8"  
 2'10" x 6'8"  
 3'0" x 6'8"

**S9353**  
**X6**  
 2'8" x 6'8"  
 2'10" x 6'8"  
 3'0" x 6'8"

**S83153**  
**X6**  
 2'8" x 8'0"  
 2'10" x 8'0"  
 3'0" x 8'0"



**S6008SL**  
**X6**  
 12" x 6'8"  
 14" x 6'8"

**S85893SL**  
**X6**  
 12" x 8'0"  
 14" x 8'0"

**S6134SL**  
**X6**  
 10" x 6'8"  
 12" x 6'8" Δ ‡  
 14" x 6'8" Δ ‡

**S85931SL**  
**X6**  
 12" x 8'0"  
 14" x 8'0"

**S6009SL**  
**X6**  
 12" x 6'8"  
 14" x 6'8"

**S895SL**  
**X6**  
 12" x 8'0"  
 14" x 8'0"

**S6006SL**  
**X6**  
 12" x 6'8"  
 14" x 6'8"

**S85916SL**  
**X6**  
 12" x 8'0"  
 14" x 8'0"



**SART**  
**X**  
 3'0" door + (2) 12" sidelites  
 Continuous Sill Systems Only

Transoms can be stained or painted to match a Fiber-Classic or Smooth-Star door system.

\*Not recommended for use behind storm doors or to be painted dark colors, if exposed to direct sunlight.  
 Note: See page 273 for important product details that may help with your purchase decision.



# Maple Park®

## Fiber-Classic® Mahogany



**FCM900**  
 ◆ ◆ ◆ 6  
 2'8" x 6'8"  
 2'10" x 6'8"  
 3'0" x 6'8"



**FCM1006**  
 ■ ◆ ◆ ◆ 6  
 2'8" x 6'8" △ ‡  
 2'10" x 6'8" △ ‡  
 3'0" x 6'8" △ ‡



**FCM902**  
 ◆ ◆ ◆ 6  
 2'8" x 6'8"  
 2'10" x 6'8"  
 3'0" x 6'8"



**FCM901**  
 ◆ ◆ ◆ 6  
 2'8" x 6'8"  
 2'10" x 6'8"  
 3'0" x 6'8"



**FCM886**  
 ◆ ◆ ◆ 6  
 2'8" x 8'0"  
 2'10" x 8'0"  
 3'0" x 8'0"



**FCM6107**  
 ◆ ◆ ◆ 6  
 2'8" x 6'8"  
 2'10" x 6'8"  
 3'0" x 6'8"



**FCM6108**  
 ◆ ◆ ◆ 6  
 2'8" x 6'8"  
 2'10" x 6'8"  
 3'0" x 6'8"



**FCM609**  
 ◆ ◆ ◆ 6  
 2'8" x 6'8"  
 2'10" x 6'8"  
 3'0" x 6'8"



**FCM904**  
 ◆ ◆ ◆  
 2'8" x 6'8"  
 2'10" x 6'8"  
 3'0" x 6'8"



**FCM736**  
 ◆ ◆ ◆  
 2'8" x 6'8"  
 2'10" x 6'8"  
 3'0" x 6'8"



**FCM8736**  
 ◆ ◆ ◆  
 2'8" x 8'0"  
 2'10" x 8'0"  
 3'0" x 8'0"



**FCM812SL**  
 ■ ◆ ◆ ◆ 6  
 10" x 6'8"  
 12" x 6'8" △ ‡  
 14" x 6'8" △ ‡



**FCM902SL**  
 ◆ ◆ ◆ 6  
 12" x 6'8"  
 14" x 6'8"



**FCM887SL**  
 ◆ ◆ ◆ 6  
 12" x 8'0"  
 14" x 8'0"



**FCM901SL**  
 ◆ ◆ ◆ 6  
 12" x 6'8"  
 14" x 6'8"



**FCM886SL**  
 ◆ ◆ ◆ 6  
 12" x 8'0"  
 14" x 8'0"

## Fiber-Classic® Oak



**FC900**  
 ◆ ◆ ◆ 6  
 2'8" x 6'8" ‡  
 2'10" x 6'8" ‡  
 3'0" x 6'8" ‡



**FC1006**  
 ■ ◆ ◆ ◆ 6  
 2'8" x 6'8" △ ‡  
 2'10" x 6'8" △ ‡  
 3'0" x 6'8" △ ‡



**FC902**  
 ◆ ◆ ◆ 6  
 2'8" x 6'8"  
 2'10" x 6'8"  
 3'0" x 6'8"



**FC777**  
 ◆ ◆ ◆ 6  
 2'8" x 6'8"  
 2'10" x 6'8"  
 3'0" x 6'8"



**81957P**  
 ◆ ◆ ◆ 6  
 2'8" x 8'0"  
 2'10" x 8'0"  
 3'0" x 8'0"



**FC901**  
 ◆ ◆ ◆ 6  
 2'6" x 6'8"  
 2'8" x 6'8" ‡  
 2'10" x 6'8" ‡  
 3'0" x 6'8" ‡



**81939P**  
 ◆ ◆ ◆ 6  
 2'8" x 8'0"  
 2'10" x 8'0"  
 3'0" x 8'0"



**81982P**  
 ◆ ◆ ◆ 6  
 2'8" x 8'0"  
 2'10" x 8'0"  
 3'0" x 8'0"

**FC903**  
 ◆ ◆ ◆  
 2'8" x 6'8"  
 2'10" x 6'8"  
 3'0" x 6'8"

Maple Park Glass *Continues on next page.*

### Key

- No Stile Lines
- ◆ Black Nickel Caming (1D)
- ◆ Brushed Nickel Caming (1C)
- ✗ Wrought Iron (1W)

- Vented Sidelite (No Impact)  
(6'6" & 6'8" only in 12" & 14")  
(8'0" only in 14")
- 6 WBDR Options
- 6 WBDR / HVHZ Options

- △ 6'6" Height Available
- ‡ 7'0" Height Available

### Optional Dentil Shelf\*



**4-Block Dentil Shelf**  
 Available for all Craftsman-style  
 Fiber-Classic Mahogany Collection doors.

## Maple Park® Glass *Continued*

|   |   |   |   |   |   |  |   |   |   |   |
|---|---|---|---|---|---|--|---|---|---|---|
|  |  |  |  |  |  |  |  |  |  |  |
| <b>FC904</b><br>◆ ◆<br>2'8" x 6'8"<br>2'10" x 6'8"<br>3'0" x 6'8"                 | <b>FC80955</b><br>◆ ◆ ◆<br>2'8" x 6'8"<br>2'10" x 6'8"<br>3'0" x 6'8"             | <b>FC86255</b><br>◆ ◆ ◆<br>2'8" x 8'0"<br>2'10" x 8'0"<br>3'0" x 8'0"             | <b>FC736</b><br>◆ ◆ ◆<br>2'8" x 6'8" ‡<br>2'10" x 6'8" ‡<br>3'0" x 6'8" ‡         | <b>FC8736</b><br>◆ ◆ ◆<br>2'8" x 8'0"<br>2'10" x 8'0"<br>3'0" x 8'0"              | <b>FC900SL</b><br>◆ ◆ ◆<br>10" x 6'8"<br>12" x 6'8"<br>14" x 6'8"                 | <b>FC812SL</b><br>◆ ◆ ◆ ◆ ◆<br>12" x 6'8" ‡ †<br>14" x 6'8" ‡ †                    | <b>FC902SL</b><br>◆ ◆ ◆ ◆<br>12" x 6'8"<br>14" x 6'8"                               | <b>81957PSL</b><br>◆ ◆ ◆ ◆<br>12" x 8'0"<br>14" x 8'0"                              | <b>FC901SL</b><br>◆ ◆ ◆ ◆<br>12" x 6'8"<br>14" x 6'8"                               | <b>81939PSL</b><br>◆ ◆ ◆ ◆<br>12" x 8'0"<br>14" x 8'0"                              |

## Smooth-Star®

|  |  |  |  |  |   |   |  |  |
|--|--|--|--|--|---|---|--|--|
|  |                  |  |  |  |  |  |  |  |
| <b>S6100</b><br>◆ ◆ ◆<br>2'8" x 6'8" ‡<br>2'10" x 6'8" ‡ †<br>3'0" x 6'8" ‡ †      | <b>S1006</b><br>◆ ◆ ◆ ◆ ◆<br>2'8" x 6'8" ‡ †<br>2'10" x 6'8" ‡ †<br>3'0" x 6'8" ‡ †<br>3'6" x 6'8" | <b>S6102</b><br>◆ ◆ ◆ ◆<br>2'8" x 6'8"<br>2'10" x 6'8"<br>3'0" x 6'8"              | <b>S6103</b><br>◆ ◆ ◆ ◆<br>2'8" x 6'8"<br>2'10" x 6'8"<br>3'0" x 6'8"              | <b>S85898</b><br>◆ ◆ ◆ ◆ ◆<br>2'8" x 8'0"<br>2'10" x 8'0"<br>3'0" x 8'0"           | <b>S6101</b><br>◆ ◆ ◆ ◆ ◆<br>2'8" x 6'8" ‡<br>2'10" x 6'8" ‡<br>3'0" x 6'8" ‡       | <b>S81939P</b><br>◆ ◆ ◆ ◆ ◆<br>2'8" x 8'0"<br>2'10" x 8'0"<br>3'0" x 8'0"           | <b>S6107</b><br>◆ ◆ ◆ ◆ ◆<br>2'8" x 6'8" ‡<br>2'10" x 6'8" ‡<br>3'0" x 6'8" ‡        | <b>S6108</b><br>◆ ◆ ◆ ◆ ◆<br>2'8" x 6'8"<br>2'10" x 6'8"<br>3'0" x 6'8"              |

|   |   |   |   |   |   |   |   |
|---|---|---|---|---|---|---|---|
|  |  |  |  |  |  |  |  |
| <b>S6106</b><br>◆ ◆ ◆ ◆<br>2'8" x 6'8"<br>2'10" x 6'8"<br>3'0" x 6'8"               | <b>S85897</b><br>◆ ◆ ◆ ◆ ◆<br>2'8" x 8'0"<br>2'10" x 8'0"<br>3'0" x 8'0"            | <b>S6104</b><br>◆ ◆ ◆ ◆<br>2'8" x 6'8"<br>2'10" x 6'8"<br>3'0" x 6'8"               | <b>S609</b><br>◆ ◆ ◆ ◆ ◆<br>2'8" x 6'8"<br>2'10" x 6'8"<br>3'0" x 6'8"              | <b>S8609</b><br>◆ ◆ ◆ ◆ ◆<br>2'8" x 8'0"<br>2'10" x 8'0"<br>3'0" x 8'0"             | <b>S6105</b><br>◆ ◆ ◆ ◆<br>2'8" x 6'8"<br>2'10" x 6'8"<br>3'0" x 6'8"               | <b>S9355</b><br>◆ ◆ ◆ ◆ ◆<br>2'8" x 6'8"<br>2'10" x 6'8"<br>3'0" x 6'8"               | <b>S83155</b><br>◆ ◆ ◆ ◆ ◆<br>2'8" x 8'0"<br>2'10" x 8'0"<br>3'0" x 8'0"              |

\*Not recommended for use behind storm doors or to be painted dark colors, if exposed to direct sunlight.  
Note: See page 273 for important product details that may help with your purchase decision.



**S736**  
◆◆  
2'8" x 6'8" ‡  
2'10" x 6'8" ‡  
3'0" x 6'8" ‡

**S8736**  
◆◆  
2'8" x 8'0"  
2'10" x 8'0"  
3'0" x 8'0"



**S6100SL**  
◆◆ 6  
12" x 6'8"  
14" x 6'8"



**S6131SL**  
◆◆◆ 6  
10" x 6'8"  
12" x 6'8" ▲‡  
14" x 6'8" ▲‡

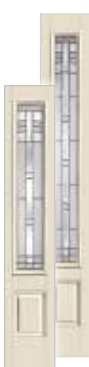

**S6102SL**  
◆◆ 6  
12" x 6'8"  
14" x 6'8"

**S85898SL**  
◆◆ 6  
12" x 8'0"  
14" x 8'0"

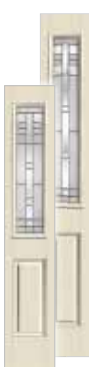

**S6101SL**  
◆◆ 6  
12" x 6'8"  
14" x 6'8"

**S85918SL**  
◆◆ 6  
12" x 8'0"  
14" x 8'0"



**FWRT** ◆◆  
3'0" door + (2) 12" sidelites  
3'0" door + (2) 14" sidelites  
Continuous Sill Systems Only

Transoms can be stained or painted to match a Fiber-Classic or Smooth-Star door system.

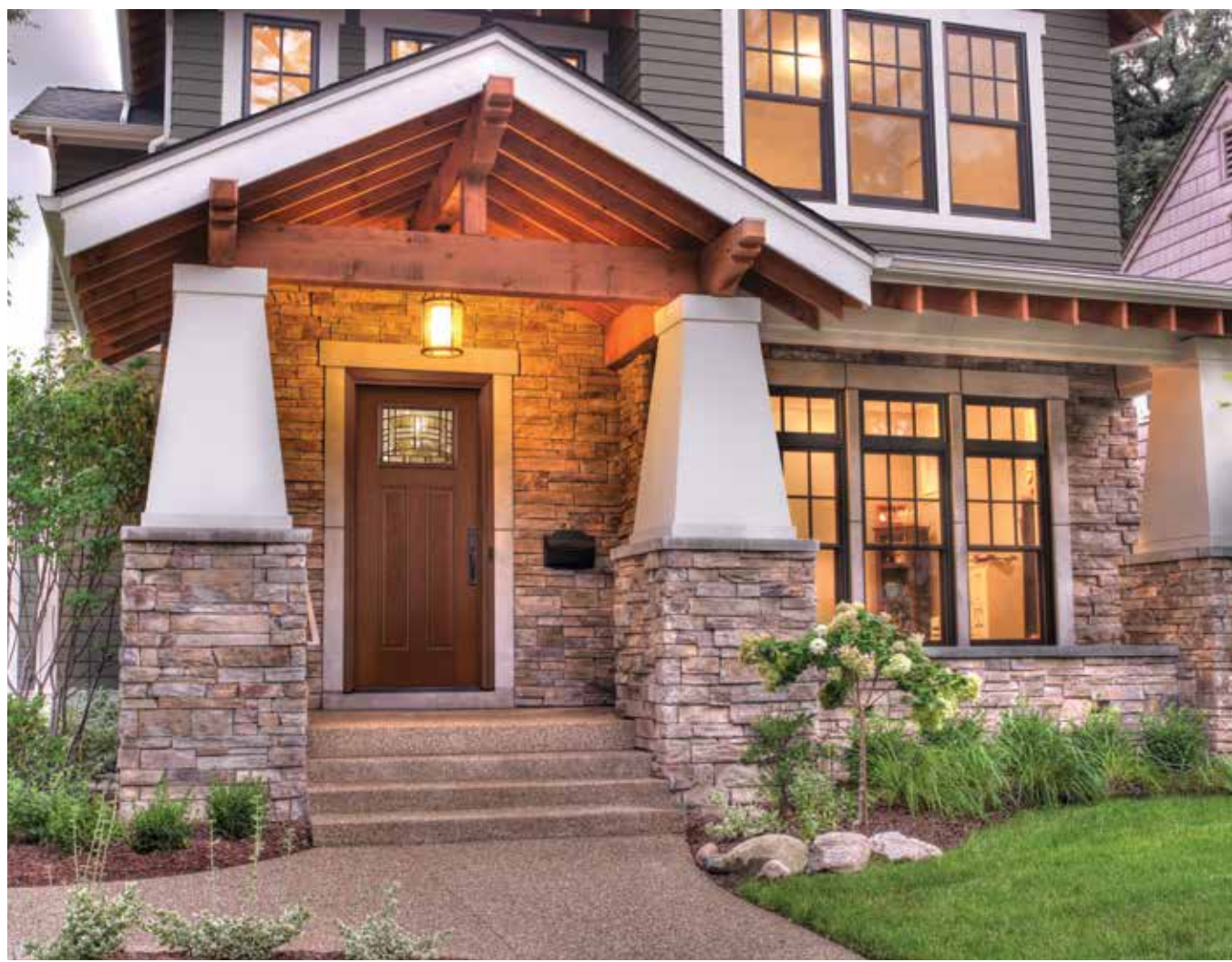

**Key**

- No Stile Lines
- ◆ Black Nickel Caming (1D)
- ◆◆ Brushed Nickel Caming (1C)

- Vented Sidelite (No Impact)  
(6'6" & 6'8" only in 12" & 14")  
(8'0" only in 14")
- 6 WBDR Options

- 6 WBDR / HVHZ Options
- ▲ 6'6" Height Available
- ‡ 7'0" Height Available

**Optional Dentil Shelf\***



**4-Block Dentil Shelf**  
Available for all Craftsman-style Smooth-Star doors.



# Avonlea®

Note: Product images show exterior side of door.

## Fiber-Classic® Mahogany



- |   |  |   |   |   |   |   |   |   |
|---|--|---|---|---|---|---|---|---|
| <p><b>FCM758</b><br/>◆ 6<br/>2'8" x 6'8"<br/>2'10" x 6'8"<br/>3'0" x 6'8"</p> | <p><b>FCM1027</b><br/>◆ 6<br/>2'8" x 6'8" △ ‡<br/>2'10" x 6'8" △ ‡<br/>3'0" x 6'8" △ ‡</p> | <p><b>FCM764</b><br/>◆ 6<br/>2'8" x 6'8"<br/>2'10" x 6'8"<br/>3'0" x 6'8"</p> | <p><b>FCM761</b><br/>◆ 6<br/>2'8" x 6'8"<br/>2'10" x 6'8"<br/>3'0" x 6'8"</p> | <p><b>FCM896</b><br/>◆ 6<br/>2'8" x 8'0"<br/>2'10" x 8'0"<br/>3'0" x 8'0"</p> | <p><b>FCM968</b><br/>◆ 6<br/>2'8" x 6'8"<br/>2'10" x 6'8"<br/>3'0" x 6'8"</p> | <p><b>FCM966</b><br/>◆ 6<br/>2'8" x 6'8"<br/>2'10" x 6'8"<br/>3'0" x 6'8"</p> | <p><b>FCM785</b><br/>◆<br/>2'8" x 6'8"<br/>2'10" x 6'8"<br/>3'0" x 6'8"</p> | <p><b>FCM788</b><br/>◆<br/>2'8" x 6'8"<br/>2'10" x 6'8"<br/>3'0" x 6'8"</p> |
|---|--|---|---|---|---|---|---|---|



- |   |   |  |   |  |  |
|---|---|--|---|--|--|
| <p><b>FCM800</b><br/>◆<br/>2'8" x 6'8"<br/>2'10" x 6'8"<br/>3'0" x 6'8"</p> | <p><b>FCM807SL</b><br/>◆ 6<br/>10" x 6'8"<br/>12" x 6'8" △ ‡<br/>14" x 6'8" △ ‡</p> | <p><b>FCM764SL</b><br/>◆ 6<br/>12" x 6'8"<br/>14" x 6'8"</p> | <p><b>FCM8104SL</b><br/>◆ 6<br/>12" x 8'0"<br/>14" x 8'0"</p> | <p><b>FCM761SL</b><br/>◆ 6<br/>12" x 6'8"<br/>14" x 6'8"</p> | <p><b>FCM896SL</b><br/>◆ 6<br/>12" x 8'0"<br/>14" x 8'0"</p> |
|---|---|--|---|--|--|

## Fiber-Classic® Oak



- |  |   |  |
|--|---|--|
| <p><b>FC758</b><br/>◆ 6<br/>2'8" x 6'8" ‡<br/>2'10" x 6'8" ‡<br/>3'0" x 6'8" ‡</p> | <p><b>FC1027</b><br/>◆ 6<br/>2'8" x 6'8" △ ‡<br/>2'10" x 6'8" △ ‡<br/>3'0" x 6'8" △ ‡</p> | <p><b>FC764</b><br/>◆ 6<br/>2'8" x 6'8"<br/>2'10" x 6'8"<br/>3'0" x 6'8"</p> |
|--|---|--|



- |  |   |  |   |   |  |  |  |  |
|--|---|--|---|---|--|--|--|--|
| <p><b>FC769</b><br/>◆ 6<br/>2'8" x 6'8"<br/>2'10" x 6'8"<br/>3'0" x 6'8"</p> | <p><b>81967P</b><br/>◆ 6<br/>2'8" x 8'0"<br/>2'10" x 8'0"<br/>3'0" x 8'0"</p> | <p><b>FC761</b><br/>◆ 6<br/>2'6" x 6'8"<br/>2'8" x 6'8" ‡<br/>2'10" x 6'8" ‡<br/>3'0" x 6'8" ‡</p> | <p><b>81932P</b><br/>◆ 6<br/>2'8" x 8'0"<br/>2'10" x 8'0"<br/>3'0" x 8'0"</p> | <p><b>81974P</b><br/>◆ 6<br/>2'8" x 8'0"<br/>2'10" x 8'0"<br/>3'0" x 8'0"</p> | <p><b>FC782</b><br/>◆<br/>2'8" x 6'8"<br/>2'10" x 6'8"<br/>3'0" x 6'8"</p> | <p><b>FC785</b><br/>◆<br/>2'8" x 6'8"<br/>2'10" x 6'8"<br/>3'0" x 6'8"</p> | <p><b>FC788</b><br/>◆<br/>2'8" x 6'8"<br/>2'10" x 6'8"<br/>3'0" x 6'8"</p> | <p><b>FC792</b><br/>◆<br/>2'8" x 6'8"<br/>2'10" x 6'8"<br/>3'0" x 6'8"</p> |
|--|---|--|---|---|--|--|--|--|



|   |   |   |   |   |   |  |   |  |
|---|---|---|---|---|---|--|---|--|
| <b>FC800</b><br>◆<br>2'8" x 6'8"<br>2'10" x 6'8"<br>3'0" x 6'8" | <b>FC80956</b><br>◆<br>2'8" x 6'8"<br>2'10" x 6'8"<br>3'0" x 6'8" | <b>FC86256</b><br>◆<br>2'8" x 8'0"<br>2'10" x 8'0"<br>3'0" x 8'0" | <b>FC758SL</b><br>◆<br>10" x 6'8"<br>12" x 6'8"<br>14" x 6'8" | <b>FC807SL</b><br>◆<br>12" x 6'8" †<br>14" x 6'8" † | <b>FC764SL</b><br>◆<br>12" x 6'8"<br>14" x 6'8" | <b>81967PSL</b><br>◆<br>12" x 8'0"<br>14" x 8'0" | <b>FC761SL</b><br>◆<br>12" x 6'8"<br>14" x 6'8" | <b>81932PSL</b><br>◆<br>12" x 8'0"<br>14" x 8'0" |
|---|---|---|---|---|---|--|---|--|

## Smooth-Star®

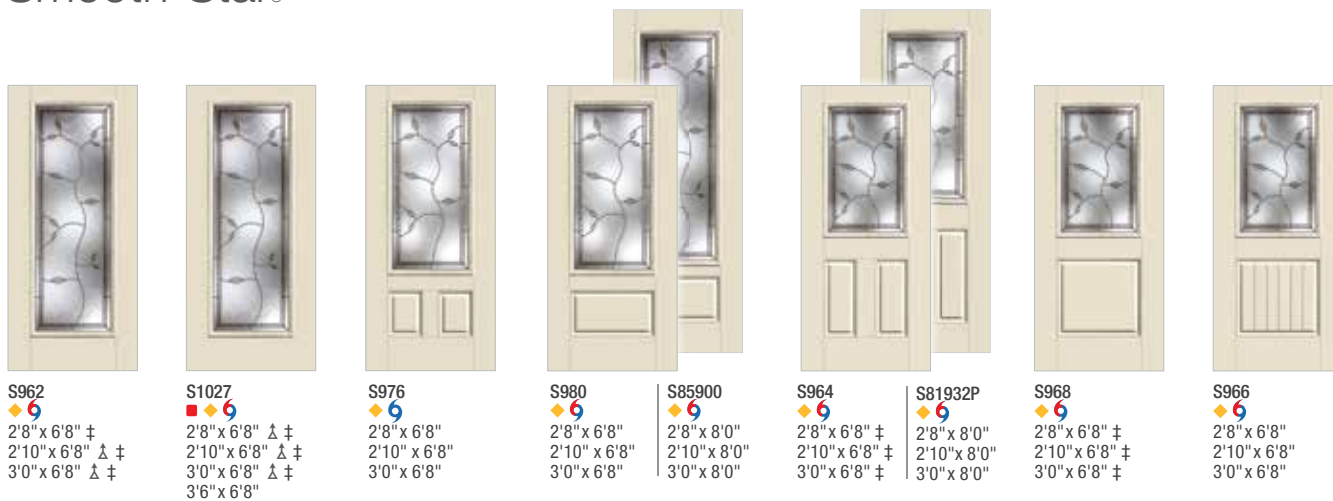

|  |  |  |  |  |  |   |  |  |
|--|--|--|--|--|--|---|--|--|
| <b>S962</b><br>◆<br>2'8" x 6'8" †<br>2'10" x 6'8" †<br>3'0" x 6'8" † | <b>S1027</b><br>◆<br>2'8" x 6'8" †<br>2'10" x 6'8" †<br>3'0" x 6'8" †<br>3'6" x 6'8" | <b>S976</b><br>◆<br>2'8" x 6'8"<br>2'10" x 6'8"<br>3'0" x 6'8" | <b>S980</b><br>◆<br>2'8" x 6'8"<br>2'10" x 6'8"<br>3'0" x 6'8" | <b>S85900</b><br>◆<br>2'8" x 8'0"<br>2'10" x 8'0"<br>3'0" x 8'0" | <b>S964</b><br>◆<br>2'8" x 6'8" †<br>2'10" x 6'8" †<br>3'0" x 6'8" † | <b>S81932P</b><br>◆<br>2'8" x 8'0"<br>2'10" x 8'0"<br>3'0" x 8'0" | <b>S968</b><br>◆<br>2'8" x 6'8" †<br>2'10" x 6'8" †<br>3'0" x 6'8" † | <b>S966</b><br>◆<br>2'8" x 6'8"<br>2'10" x 6'8"<br>3'0" x 6'8" |
|--|--|--|--|--|--|---|--|--|

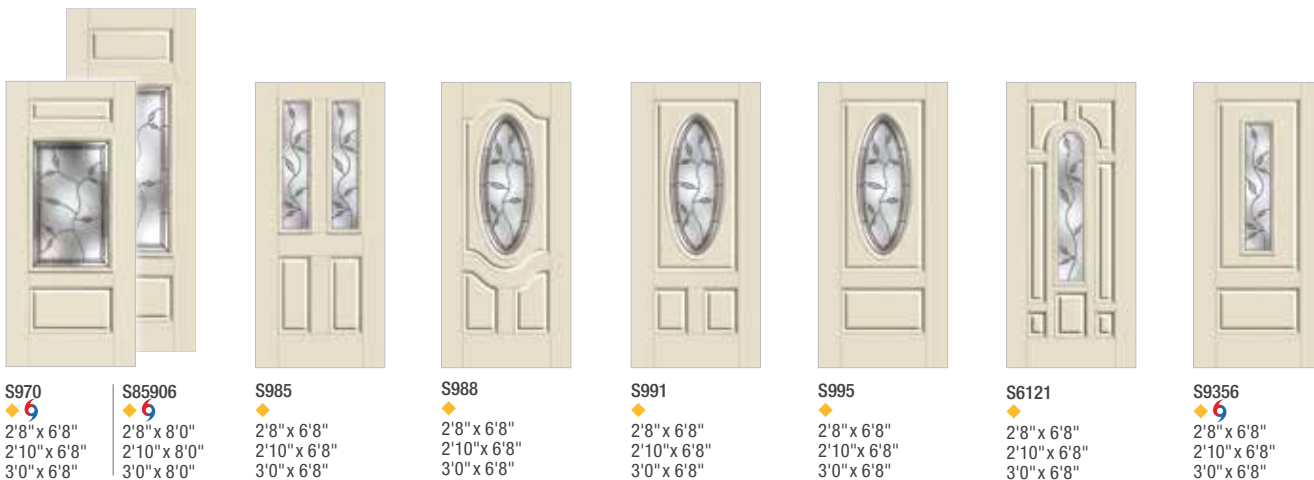

|  |  |  |  |  |  |   |   |
|--|--|--|--|--|--|---|---|
| <b>S970</b><br>◆<br>2'8" x 6'8"<br>2'10" x 6'8"<br>3'0" x 6'8" | <b>S85906</b><br>◆<br>2'8" x 8'0"<br>2'10" x 8'0"<br>3'0" x 8'0" | <b>S985</b><br>◆<br>2'8" x 6'8"<br>2'10" x 6'8"<br>3'0" x 6'8" | <b>S988</b><br>◆<br>2'8" x 6'8"<br>2'10" x 6'8"<br>3'0" x 6'8" | <b>S991</b><br>◆<br>2'8" x 6'8"<br>2'10" x 6'8"<br>3'0" x 6'8" | <b>S995</b><br>◆<br>2'8" x 6'8"<br>2'10" x 6'8"<br>3'0" x 6'8" | <b>S6121</b><br>◆<br>2'8" x 6'8"<br>2'10" x 6'8"<br>3'0" x 6'8" | <b>S9356</b><br>◆<br>2'8" x 6'8"<br>2'10" x 6'8"<br>3'0" x 6'8" |
|--|--|--|--|--|--|---|---|

Avonlea Glass Continues on next page.

### Key

- No Stile Lines
- ◆ Black Nickel Caming (1D)
- Vented Sidelite (No Impact)  
(6'6" & 6'8" only in 12" & 14")  
(8'0" only in 14")
- 6 WBDR Options
- 6 WBDR / HVHZ Options
- △ 6'6" Height Available
- ‡ 7'0" Height Available

**Avonlea® Glass** *Continued*

Note: Product images show exterior side of door.



**S83156**  
 ◆ 6  
 2'8" x 8'0"  
 2'10" x 8'0"  
 3'0" x 8'0"



**S962SL**  
 ◆ 6  
 12" x 6'8"  
 14" x 6'8"



**S6127SL**  
 ◆ 6  
 10" x 6'8"  
 12" x 6'8" † ‡  
 14" x 6'8" † ‡



**S976SL**  
 ◆ 6  
 12" x 6'8"  
 14" x 6'8"



**S85900SL**  
 ◆ 6  
 12" x 8'0"  
 14" x 8'0"

**S964SL**  
 ◆ 6  
 12" x 6'8"  
 14" x 6'8"

**S85911SL**  
 ◆ 6  
 12" x 8'0"  
 14" x 8'0"



**AVRT** ◆  
 3'0" door + (2) 12" sidelites  
 3'0" door + (2) 14" sidelites  
 Continuous Sill Systems Only

Transoms can be stained or painted to match a Fiber-Classic or Smooth-Star door system.

**Saratoga™**

Fiber-Classic® Mahogany



**FCM905**  
 ◆ 6  
 2'8" x 6'8"  
 2'10" x 6'8"  
 3'0" x 6'8"



**FCM6093**  
 ◆ 6  
 2'6" x 6'8" † ‡  
 2'8" x 6'8" † ‡  
 2'10" x 6'8" † ‡  
 3'0" x 6'8" † ‡



**FCM907**  
 ◆ 6  
 2'8" x 6'8"  
 2'10" x 6'8"  
 3'0" x 6'8"



**FCM906**  
 ◆ 6  
 2'8" x 6'8"  
 2'10" x 6'8"  
 3'0" x 6'8"



**FCM888**  
 ◆ 6  
 2'8" x 8'0"  
 2'10" x 8'0"  
 3'0" x 8'0"



**FCM6029**  
 ◆ 6  
 2'8" x 6'8"  
 2'10" x 6'8"  
 3'0" x 6'8"



**FCM6049**  
 ◆ 6  
 2'8" x 6'8"  
 2'10" x 6'8"  
 3'0" x 6'8"



**FCM602**  
 ◆ 6  
 2'8" x 6'8"  
 2'10" x 6'8"  
 3'0" x 6'8"



**FCM909**  
 ◆ 6  
 2'8" x 6'8"  
 2'10" x 6'8"  
 3'0" x 6'8"



**FCM707**  
 ◆ 6  
 2'8" x 6'8"  
 2'10" x 6'8"  
 3'0" x 6'8"



**FCM815SL**  
 ◆ 6  
 10" x 6'8"  
 12" x 6'8" † ‡  
 14" x 6'8" † ‡



**FCM81986SL**  
 ◆ 6  
 12" x 8'0"  
 14" x 8'0"



**FCM893SL**  
 ◆ 6  
 12" x 8'0"  
 14" x 8'0"



**FCM907SL**  
 ◆ 6  
 12" x 6'8"  
 14" x 6'8"



**FCM889SL**  
 ◆ 6  
 12" x 8'0"  
 14" x 8'0"



**FCM906SL**  
 ◆ 6  
 12" x 6'8"  
 14" x 6'8"



**FCM888SL**  
 ◆ 6  
 12" x 8'0"  
 14" x 8'0"

**FC905**  
 ◆ 6  
 2'6" x 6'8"  
 2'8" x 6'8" † ‡  
 2'10" x 6'8" † ‡  
 3'0" x 6'8" † ‡

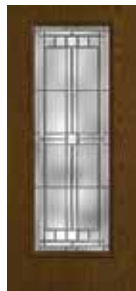

**FC6093**  
 ◆ 6  
 2'6" x 6'8" † ‡  
 2'8" x 6'8" † ‡  
 2'10" x 6'8" † ‡  
 3'0" x 6'8" † ‡

Fiber-Classic®  
Oak

\*Not recommended for use behind storm doors or to be painted dark colors, if exposed to direct sunlight.  
 Note: See page 273 for important product details that may help with your purchase decision.





|   |   |  |  |  |  |   |   |   |
|---|---|--|--|--|--|---|---|---|
| <b>FC907</b><br>◆ ■ ■ ■ 6<br>2'8" x 6'8"<br>2'10" x 6'8"<br>3'0" x 6'8" | <b>FC776</b><br>◆ ■ ■ ■ 6<br>2'8" x 6'8"<br>2'10" x 6'8"<br>3'0" x 6'8" | <b>81956P</b><br>◆ ■ ■ ■ 6<br>2'8" x 8'0"<br>2'10" x 8'0"<br>3'0" x 8'0" | <b>FC906</b><br>◆ ■ ■ ■ 6<br>2'6" x 6'8"<br>2'8" x 6'8" ‡<br>2'10" x 6'8" ‡<br>3'0" x 6'8" ‡ | <b>81938P</b><br>◆ ■ ■ ■ 6<br>2'8" x 8'0"<br>2'10" x 8'0"<br>3'0" x 8'0" | <b>81981P</b><br>◆ ■ ■ ■ 6<br>2'8" x 8'0"<br>2'10" x 8'0"<br>3'0" x 8'0" | <b>FC908</b><br>◆ ■ ■ ■<br>2'8" x 6'8"<br>2'10" x 6'8"<br>3'0" x 6'8" | <b>FC909</b><br>◆ ■ ■ ■<br>2'8" x 6'8"<br>2'10" x 6'8"<br>3'0" x 6'8" | <b>FC80954</b><br>◆ ■ ■ ■ 6<br>2'8" x 6'8"<br>2'10" x 6'8"<br>3'0" x 6'8" |
|---|---|--|--|--|--|---|---|---|



|   |   |  |   |  |   |   |   |  |   |  |
|---|---|--|---|--|---|---|---|--|---|--|
| <b>FC86254</b><br>◆ ■ ■ ■ 6<br>2'8" x 8'0"<br>2'10" x 8'0"<br>3'0" x 8'0" | <b>FC707</b><br>◆ ■ ■ ■<br>2'8" x 6'8" ‡<br>2'10" x 6'8" ‡<br>3'0" x 6'8" ‡ | <b>FC8707</b><br>◆ ■ ■ ■<br>2'8" x 8'0"<br>2'10" x 8'0"<br>3'0" x 8'0" | <b>FC905SL</b><br>◆ ■ ■ ■ 6<br>10" x 6'8"<br>12" x 6'8" | <b>81986PSL</b><br>◆ ■ ■ ■ 6<br>12" x 8'0"<br>14" x 8'0" | <b>FC815SL</b><br>◆ ■ ■ ■ 6<br>12" x 6'8" ‡ †<br>14" x 6'8" ‡ † | <b>81986SL</b><br>◆ ■ ■ ■ 6<br>12" x 8'0"<br>14" x 8'0" | <b>FC907SL</b><br>◆ ■ ■ ■ 6<br>12" x 6'8"<br>14" x 6'8" | <b>81956PSL</b><br>◆ ■ ■ ■ 6<br>12" x 8'0"<br>14" x 8'0" | <b>FC906SL</b><br>◆ ■ ■ ■ 6<br>12" x 6'8"<br>14" x 6'8" | <b>81938PSL</b><br>◆ ■ ■ ■ 6<br>12" x 8'0"<br>14" x 8'0" |
|---|---|--|---|--|---|---|---|--|---|--|

## Smooth-Star®



|   |   |   |  |  |   |   |   |   |
|---|---|---|--|--|---|---|---|---|
| <b>S154</b><br>◆ ■ ■ ■ 6<br>2'6" x 6'8" †<br>2'8" x 6'8" † ‡<br>2'10" x 6'8" † ‡<br>3'0" x 6'8" † ‡ | <b>S6093</b><br>◆ ■ ■ ■ 6<br>2'6" x 6'8" †<br>2'8" x 6'8" † ‡<br>2'10" x 6'8" † ‡<br>3'0" x 6'8" † ‡<br>3'6" x 6'8" | <b>S6092</b><br>◆ ■ ■ ■ 6<br>2'8" x 6'8"<br>2'10" x 6'8"<br>3'0" x 6'8" | <b>S982</b><br>◆ ■ ■ ■ 6<br>2'8" x 6'8"<br>2'10" x 6'8"<br>3'0" x 6'8" | <b>S891</b><br>◆ ■ ■ ■ 6<br>2'8" x 8'0"<br>2'10" x 8'0"<br>3'0" x 8'0" | <b>S213</b><br>◆ ■ ■ ■ 6<br>2'6" x 6'8"<br>2'8" x 6'8" ‡<br>2'10" x 6'8" ‡<br>3'0" x 6'8" ‡ | <b>S81938P</b><br>◆ ■ ■ ■ 6<br>2'8" x 8'0"<br>2'10" x 8'0"<br>3'0" x 8'0" | <b>S6029</b><br>◆ ■ ■ ■ 6<br>2'8" x 6'8" ‡<br>2'10" x 6'8" ‡<br>3'0" x 6'8" ‡ | <b>S6049</b><br>◆ ■ ■ ■ 6<br>2'8" x 6'8"<br>2'10" x 6'8"<br>3'0" x 6'8" |
|---|---|---|--|--|---|---|---|---|

Saratoga Glass *Continues on next page.*

### Key

- No Stile Lines
- ◆ Black Nickel Caming (1D)
- ■ ■ ■ Brushed Nickel Caming (1C)
- Vented Sidelite (No Impact)  
(6'6" & 6'8" only in 12" & 14"  
(8'0" only in 14")
- ⚡ WBDR Options
- ⚡ 6'6" Height Available
- ‡ 7'0" Height Available

### Optional Dentil Shelf\*





**S41**  
◆ ■ 6  
2'8" x 6'8"  
2'10" x 6'8"  
3'0" x 6'8"



**S85908**  
◆ ■ 6  
2'8" x 8'0"  
2'10" x 8'0"  
3'0" x 8'0"



**S291**  
◆ ■ ■  
2'8" x 6'8"  
2'10" x 6'8"  
3'0" x 6'8"



**S602**  
◆ ■ 6  
2'8" x 6'8"  
2'10" x 6'8"  
3'0" x 6'8"



**S8602**  
◆ ■ 6  
2'8" x 8'0"  
2'10" x 8'0"  
3'0" x 8'0"



**S20**  
◆ ■ ■  
2'8" x 6'8"  
2'10" x 6'8"  
3'0" x 6'8"



**S9354**  
◆ ■ 6  
2'8" x 6'8"  
2'10" x 6'8"  
3'0" x 6'8"

**S83154**  
◆ ■ 6  
2'8" x 8'0"  
2'10" x 8'0"  
3'0" x 8'0"



**S707**  
◆ ■ ■  
2'8" x 6'8" ‡  
2'10" x 6'8" ‡  
3'0" x 6'8" ‡

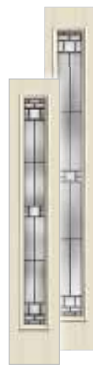

**S8707**  
◆ ■ ■  
2'8" x 8'0"  
2'10" x 8'0"  
3'0" x 8'0"

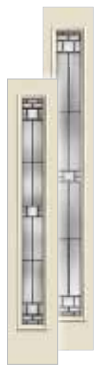

**S154SL**  
◆ ■ 6  
12" x 6'8"  
14" x 6'8"



**S8602SL**  
◆ ■ 6  
12" x 8'0"  
14" x 8'0"



**S602SL**  
◆ ■ ■ 6  
10" x 6'8"  
12" x 6'8" † ‡  
14" x 6'8" † ‡



**S85932SL**  
◆ ■ ■ ■ 6  
12" x 8'0"  
14" x 8'0"



**19740T**  
◆ ■ ■  
3'0" Door Only



**19750T**  
◆ ■ ■  
3'0" door + (2) 12" sidelites  
Continuous Sill Systems Only

**S6092SL**  
◆ ■ 6  
12" x 6'8"  
14" x 6'8"

**S891SL**  
◆ ■ 6  
12" x 8'0"  
14" x 8'0"

**S291SL**  
◆ ■ 6  
12" x 6'8"  
14" x 6'8"

Transoms can be stained or painted to match a Fiber-Classic or Smooth-Star door system.

## Texas Star

### Fiber-Classic® Mahogany



**FCM142**  
■ ■ 6  
2'8" x 6'8"  
2'10" x 6'8"  
3'0" x 6'8"



**FCM1029**  
■ ■ 6  
2'8" x 6'8" † ‡  
2'10" x 6'8" † ‡  
3'0" x 6'8" † ‡



**FCM143**  
■ ■ 6  
2'8" x 6'8"  
2'10" x 6'8"  
3'0" x 6'8"



**FCM144**  
■ ■ 6  
2'8" x 6'8"  
2'10" x 6'8"  
3'0" x 6'8"



**FCM899**  
■ ■ 6  
2'8" x 8'0"  
2'10" x 8'0"  
3'0" x 8'0"



**FCM6074**  
■ ■ 6  
2'8" x 6'8"  
2'10" x 6'8"  
3'0" x 6'8"



**FCM6075**  
■ ■ 6  
2'8" x 6'8"  
2'10" x 6'8"  
3'0" x 6'8"



**FCM146**  
■ ■ ■  
2'8" x 6'8"  
2'10" x 6'8"  
3'0" x 6'8"



**FCM165**  
■ ■ ■  
2'8" x 6'8"  
2'10" x 6'8"  
3'0" x 6'8"

\*Not recommended for use behind storm doors or to be painted dark colors, if exposed to direct sunlight.  
Note: See page 273 for important product details that may help with your purchase decision.

## Fiber-Classic® Oak



|  |  |   |  |  |
|--|--|---|--|--|
| <b>FCM817SL</b><br>■ ■ ■ ● 6<br>10" x 6'8"<br>12" x 6'8" Δ ‡<br>14" x 6'8" Δ ‡ | <b>FCM143SL</b><br>■ ■ 6<br>12" x 6'8"<br>14" x 6'8" | <b>FCM8103SL</b><br>■ ■ 6<br>12" x 8'0"<br>14" x 8'0" | <b>FCM144SL</b><br>■ ■ 6<br>12" x 6'8"<br>14" x 6'8" | <b>FCM899SL</b><br>■ ■ 6<br>12" x 8'0"<br>14" x 8'0" |
|--|--|---|--|--|



|   |  |   |   |  |
|---|--|---|---|--|
| <b>FC142</b><br>■ ■ 6<br>2'8" x 6'8" ‡<br>2'10" x 6'8" ‡<br>3'0" x 6'8" ‡ | <b>FC1029</b><br>■ ■ 6<br>2'8" x 6'8" Δ ‡<br>2'10" x 6'8" Δ ‡<br>3'0" x 6'8" Δ ‡ | <b>FC143</b><br>■ ■ 6<br>2'8" x 6'8"<br>2'10" x 6'8"<br>3'0" x 6'8" | <b>FC778</b><br>■ ■ 6<br>2'8" x 6'8"<br>2'10" x 6'8"<br>3'0" x 6'8" | <b>81958P</b><br>■ ■ 6<br>2'8" x 8'0"<br>2'10" x 8'0"<br>3'0" x 8'0" |
|---|--|---|---|--|



|  |  |  |   |   |   |   |   |
|--|--|--|---|---|---|---|---|
| <b>FC144</b><br>■ ■ 6<br>2'6" x 6'8"<br>2'8" x 6'8" ‡<br>2'10" x 6'8" ‡<br>3'0" x 6'8" ‡ | <b>81940P</b><br>■ ■ 6<br>2'8" x 8'0"<br>2'10" x 8'0"<br>3'0" x 8'0" | <b>81983P</b><br>■ ■ 6<br>2'8" x 8'0"<br>2'10" x 8'0"<br>3'0" x 8'0" | <b>FC145</b><br>■ ■<br>2'8" x 6'8"<br>2'10" x 6'8"<br>3'0" x 6'8" | <b>FC146</b><br>■ ■<br>2'8" x 6'8"<br>2'10" x 6'8"<br>3'0" x 6'8" | <b>FC165</b><br>■ ■<br>2'8" x 6'8"<br>2'10" x 6'8"<br>3'0" x 6'8" | <b>FC795</b><br>■ ■<br>2'8" x 6'8"<br>2'10" x 6'8"<br>3'0" x 6'8" | <b>FC80957</b><br>■ ■ 6<br>2'8" x 6'8"<br>2'10" x 6'8"<br>3'0" x 6'8" |
|--|--|--|---|---|---|---|---|

## Smooth-Star®



|   |   |   |   |  |   |  |
|---|---|---|---|--|---|--|
| <b>FC86257</b><br>■ ■ 6<br>2'8" x 8'0"<br>2'10" x 8'0"<br>3'0" x 8'0" | <b>FC142SL</b><br>■ ■ 6<br>10" x 6'8"<br>12" x 6'8"<br>14" x 6'8" | <b>FC817SL</b><br>■ ■ ■ ● 6<br>12" x 6'8" Δ ‡<br>14" x 6'8" Δ ‡ | <b>FC143SL</b><br>■ ■ 6<br>12" x 6'8"<br>14" x 6'8" | <b>81958PSL</b><br>■ ■ 6<br>12" x 8'0"<br>14" x 8'0" | <b>FC144SL</b><br>■ ■ 6<br>12" x 6'8"<br>14" x 6'8" | <b>81940PSL</b><br>■ ■ 6<br>12" x 8'0"<br>14" x 8'0" |
|---|---|---|---|--|---|--|



|   |  |   |
|---|--|---|
| <b>S6070</b><br>■ ■ 6<br>2'8" x 6'8" ‡<br>2'10" x 6'8" Δ ‡<br>3'0" x 6'8" Δ ‡ | <b>S1029</b><br>■ ■ 6<br>2'8" x 6'8" Δ ‡<br>2'10" x 6'8" Δ ‡<br>3'0" x 6'8" Δ ‡<br>3'6" x 6'8" | <b>S6071</b><br>■ ■ 6<br>2'8" x 6'8"<br>2'10" x 6'8"<br>3'0" x 6'8" |
|---|--|---|

Texas Star Glass *Continues on next page.*

### Key

- No Stile Lines
- ◆ Black Nickel Caming (1D)
- ■ Brushed Nickel Caming (1C)
- Vented Sidelite (No Impact)  
(6'6" & 6'8" only in 12" & 14")  
(8'0" only in 14")
- 6 WBDR Options
- Δ 6'6" Height Available  
(8'0" only in 14")
- ‡ 7'0" Height Available

### Optional Dentil Shelf\*





**Texas Star Glass** *Continued*



S6072

2'8" x 6'8"  
2'10" x 6'8"  
3'0" x 6'8"

S85901

2'8" x 8'0"  
2'10" x 8'0"  
3'0" x 8'0"

S6073

2'8" x 6'8" ‡  
2'10" x 6'8" ‡  
3'0" x 6'8" ‡

S81940P

2'8" x 8'0"  
2'10" x 8'0"  
3'0" x 8'0"

S6075

2'8" x 6'8"  
2'10" x 6'8"  
3'0" x 6'8"

S6074

2'8" x 6'8" ‡  
2'10" x 6'8" ‡  
3'0" x 6'8" ‡

S6076

2'8" x 6'8"  
2'10" x 6'8"  
3'0" x 6'8"

S81983

2'8" x 8'0"  
2'10" x 8'0"  
3'0" x 8'0"

S6077

2'8" x 6'8"  
2'10" x 6'8"  
3'0" x 6'8"

S6078

2'8" x 6'8"  
2'10" x 6'8"  
3'0" x 6'8"



S6079

2'8" x 6'8"  
2'10" x 6'8"  
3'0" x 6'8"

S998

2'8" x 6'8"  
2'10" x 6'8"  
3'0" x 6'8"

S9357

2'8" x 6'8"  
2'10" x 6'8"  
3'0" x 6'8"

S83157

2'8" x 8'0"  
2'10" x 8'0"  
3'0" x 8'0"

S6070SL

12" x 6'8"  
14" x 6'8"

S6135SL

10" x 6'8"  
12" x 6'8" † ‡  
14" x 6'8" † ‡

S6071SL

12" x 6'8"  
14" x 6'8"

85901SL

12" x 8'0"  
14" x 8'0"

S6073SL

12" x 6'8"  
14" x 6'8"

85919SL

12" x 8'0"  
14" x 8'0"

**Wellesley™**

Fiber-Classic.® Mahogany



FCM104

2'8" x 6'8"  
2'10" x 6'8"  
3'0" x 6'8"

FCM874

2'8" x 8'0"  
2'10" x 8'0"  
3'0" x 8'0"

FCM6094

2'6" x 6'8" † ‡  
2'8" x 6'8" † ‡  
2'10" x 6'8" † ‡  
3'0" x 6'8" † ‡

FCM821

2'6" x 8'0"  
2'8" x 8'0"  
2'10" x 8'0"  
3'0" x 8'0"

FCM147

2'8" x 6'8"  
2'10" x 6'8"  
3'0" x 6'8"

FCM105

2'8" x 6'8"  
2'10" x 6'8"  
3'0" x 6'8"

FCM866

2'8" x 8'0"  
2'10" x 8'0"  
3'0" x 8'0"

FCM6030

2'8" x 6'8"  
2'10" x 6'8"  
3'0" x 6'8"

FCM6050

2'8" x 6'8"  
2'10" x 6'8"  
3'0" x 6'8"



**FCM106**  
 ◆ ■ ■ ■ 6  
 2'8" x 6'8"  
 2'10" x 6'8"  
 3'0" x 6'8"



**FCM163**  
 ◆ ■ ■ ■ 6  
 2'8" x 6'8"  
 2'10" x 6'8"  
 3'0" x 6'8"



**FCM125**  
 ◆ ■ ■ ■ 6  
 2'8" x 6'8"  
 2'10" x 6'8"  
 3'0" x 6'8"



**FCM721**  
 ◆ ■ ■ ■ 6  
 2'8" x 6'8"  
 2'10" x 6'8"  
 3'0" x 6'8"



**FCM8721**  
 ◆ ■ ■ ■ 6  
 2'8" x 8'0"  
 2'10" x 8'0"  
 3'0" x 8'0"



**FCM818SL**  
 ● ◆ ■ ■ ■ 6  
 10" x 6'8"  
 12" x 6'8" †  
 14" x 6'8" †



**FCM81921SL**  
 ● ◆ ■ ■ ■ 6  
 12" x 8'0"  
 14" x 8'0"

**FCM874SL**  
 ◆ ■ ■ ■ 6  
 12" x 8'0"  
 14" x 8'0"

## Fiber-Classic® Oak



**FCM147SL**  
 ◆ ■ ■ ■ 6  
 12" x 6'8"  
 14" x 6'8"



**FCM885SL**  
 ◆ ■ ■ ■ 6  
 12" x 8'0"  
 14" x 8'0"



**FCM105SL**  
 ◆ ■ ■ ■ 6  
 12" x 6'8"  
 14" x 6'8"

**FCM866SL**  
 ◆ ■ ■ ■ 6  
 12" x 8'0"  
 14" x 8'0"



**FC104**  
 ◆ ■ ■ ■ 6  
 2'6" x 6'8"  
 2'8" x 6'8" †  
 2'10" x 6'8" †  
 3'0" x 6'8" †

**81921P**  
 ◆ ■ ■ ■ 6  
 2'8" x 8'0"  
 2'10" x 8'0"  
 3'0" x 8'0"



**FC6094**  
 ■ ◆ ■ ■ ■ 6  
 2'6" x 6'8" †  
 2'8" x 6'8" †  
 2'10" x 6'8" †  
 3'0" x 6'8" †



**FC821**  
 ■ ◆ ■ ■ ■ 6  
 2'6" x 8'0"  
 2'8" x 8'0"  
 2'10" x 8'0"  
 3'0" x 8'0"



**FC147**  
 ◆ ■ ■ ■ 6  
 2'8" x 6'8"  
 2'10" x 6'8"  
 3'0" x 6'8"

**FC779**  
 ◆ ■ ■ ■ 6  
 2'8" x 6'8"  
 2'10" x 6'8"  
 3'0" x 6'8"



**FC105**  
 ◆ ■ ■ ■ 6  
 2'6" x 6'8"  
 2'8" x 6'8" †  
 2'10" x 6'8" †  
 3'0" x 6'8" †



**81941P**  
 ◆ ■ ■ ■ 6  
 2'8" x 8'0"  
 2'10" x 8'0"  
 3'0" x 8'0"



**81984P**  
 ◆ ■ ■ ■ 6  
 2'8" x 8'0"  
 2'10" x 8'0"  
 3'0" x 8'0"



**FC127**  
 ◆ ■ ■ ■ 6  
 2'8" x 6'8"  
 2'10" x 6'8"  
 3'0" x 6'8"



**FC713**  
 ◆ ■ ■ ■ 6  
 2'8" x 6'8"  
 2'10" x 6'8"  
 3'0" x 6'8"



**FC163**  
 ◆ ■ ■ ■ 6  
 2'8" x 6'8"  
 2'10" x 6'8"  
 3'0" x 6'8"



**FC796**  
 ◆ ■ ■ ■ 6  
 2'8" x 6'8"  
 2'10" x 6'8"  
 3'0" x 6'8"

### Key

- No Stile Lines
- ◆ Black Nickel Caming (1D)
- ■ ■ Brushed Nickel Caming (1C)
- ◆ ■ ■ ■ Brass Caming (1A)

- Vented Sidelite (No Impact)  
(6'6" & 6'8" only in 12" & 14")  
(8'0" only in 14")
- 6 WBDR Options
- 6 WBDR / HVHZ Options

- △ 6'6" Height Available
- ‡ 7'0" Height Available

Wellesley Glass *Continues on next page.*



|  |  |  |   |  |  |   |   |   |  |   |  |
|--|--|--|---|--|--|---|---|---|--|---|--|
| <b>FC80949</b><br>◆ ◆ ◆ ◆ 6<br>2'8" x 6'8"    †<br>2'10" x 6'8"    †<br>3'0" x 6'8"    † | <b>FC86249</b><br>◆ ◆ ◆ ◆ 6<br>2'8" x 8'0"    †<br>2'10" x 8'0"    †<br>3'0" x 8'0"    † | <b>FC721</b><br>◆ ◆ ◆ ◆<br>2'8" x 6'8"    †<br>2'10" x 6'8"    †<br>3'0" x 6'8"    † | <b>FC8721</b><br>◆ ◆ ◆ ◆<br>2'8" x 8'0"    †<br>2'10" x 8'0"    †<br>3'0" x 8'0"    † | <b>FC104SL</b><br>◆ ◆ ◆ ◆ 6<br>10" x 6'8"    †<br>12" x 6'8"    †<br>14" x 6'8"    † | <b>81921PSL</b><br>◆ ◆ ◆ ◆ 6<br>12" x 8'0"    †<br>14" x 8'0"    † | <b>FC818SL</b><br>◆ ◆ ◆ ◆<br>12" x 6'8"    †<br>14" x 6'8"    † | <b>81921SL</b><br>◆ ◆ ◆ ◆ 6<br>12" x 8'0"    †<br>14" x 8'0"    † | <b>FC147SL</b><br>◆ ◆ ◆ ◆ 6<br>12" x 6'8"    †<br>14" x 6'8"    † | <b>81959PSL</b><br>◆ ◆ ◆ ◆ 6<br>12" x 8'0"    †<br>14" x 8'0"    † | <b>FC105SL</b><br>◆ ◆ ◆ ◆ 6<br>12" x 6'8"    †<br>14" x 6'8"    † | <b>81941PSL</b><br>◆ ◆ ◆ ◆ 6<br>12" x 8'0"    †<br>14" x 8'0"    † |
|--|--|--|---|--|--|---|---|---|--|---|--|

## Smooth-Star®



|   |   |  |   |  |   |   |   |  |  |  |
|---|---|--|---|--|---|---|---|--|--|--|
| <b>S155</b><br>◆ ◆ ◆ ◆ 6<br>2'6" x 6'8"    †<br>2'8" x 6'8"    †<br>2'10" x 6'8"    †<br>3'0" x 6'8"    † | <b>S85896</b><br>◆ ◆ ◆ ◆ 6<br>2'6" x 8'0"    †<br>2'8" x 8'0"    †<br>2'10" x 8'0"    †<br>3'0" x 8'0"    † | <b>S6094</b><br>◆ ◆ ◆ ◆ 6<br>2'6" x 6'8"    †<br>2'8" x 6'8"    †<br>2'10" x 6'8"    †<br>3'0" x 6'8"    †<br>3'6" x 6'8"    † | <b>S821</b><br>◆ ◆ ◆ ◆ 6<br>2'6" x 8'0"    †<br>2'8" x 8'0"    †<br>2'10" x 8'0"    †<br>3'0" x 8'0"    †<br>3'6" x 8'0"    † | <b>S6091</b><br>◆ ◆ ◆ ◆ 6<br>2'8" x 6'8"    †<br>2'10" x 6'8"    †<br>3'0" x 6'8"    † | <b>S983</b><br>◆ ◆ ◆ ◆ 6<br>2'8" x 6'8"    †<br>2'10" x 6'8"    †<br>3'0" x 6'8"    † | <b>S892</b><br>◆ ◆ ◆ ◆ 6<br>2'8" x 8'0"    †<br>2'10" x 8'0"    †<br>3'0" x 8'0"    † | <b>S214</b><br>◆ ◆ ◆ ◆ 6<br>2'6" x 6'8"    †<br>2'8" x 6'8"    †<br>2'10" x 6'8"    †<br>3'0" x 6'8"    † | <b>S81941P</b><br>◆ ◆ ◆ ◆ 6<br>2'8" x 8'0"    †<br>2'10" x 8'0"    †<br>3'0" x 8'0"    † | <b>S6030</b><br>◆ ◆ ◆ ◆ 6<br>2'6" x 6'8"    †<br>2'8" x 6'8"    †<br>2'10" x 6'8"    †<br>3'0" x 6'8"    † | <b>S6050</b><br>◆ ◆ ◆ ◆ 6<br>2'8" x 6'8"    †<br>2'10" x 6'8"    †<br>3'0" x 6'8"    † |
|---|---|--|---|--|---|---|---|--|--|--|



|  |   |   |   |  |   |  |  |   |
|--|---|---|---|--|---|--|--|---|
| <b>S42</b><br>◆ ◆ ◆ ◆ 6<br>2'8" x 6'8"    †<br>2'10" x 6'8"    †<br>3'0" x 6'8"    † | <b>S85909</b><br>◆ ◆ ◆ ◆ 6<br>2'8" x 8'0"    †<br>2'10" x 8'0"    †<br>3'0" x 8'0"    † | <b>S292</b><br>◆ ◆ ◆ ◆<br>2'8" x 6'8"    †<br>2'10" x 6'8"    †<br>3'0" x 6'8"    † | <b>S774</b><br>◆ ◆ ◆ ◆<br>2'8" x 6'8"    †<br>2'10" x 6'8"    †<br>3'0" x 6'8"    † | <b>S6082</b><br>◆ ◆ ◆ ◆<br>2'8" x 6'8"    †<br>2'10" x 6'8"    †<br>3'0" x 6'8"    † | <b>S999</b><br>◆ ◆ ◆ ◆<br>2'8" x 6'8"    †<br>2'10" x 6'8"    †<br>3'0" x 6'8"    † | <b>S6117</b><br>◆ ◆ ◆ ◆<br>2'8" x 6'8"    †<br>2'10" x 6'8"    †<br>3'0" x 6'8"    † | <b>S9349</b><br>◆ ◆ ◆ ◆ 6<br>2'8" x 6'8"    †<br>2'10" x 6'8"    †<br>3'0" x 6'8"    † | <b>S83149</b><br>◆ ◆ ◆ ◆ 6<br>2'8" x 8'0"    †<br>2'10" x 8'0"    †<br>3'0" x 8'0"    † |
|--|---|---|---|--|---|--|--|---|

\*Not recommended for use behind storm doors or to be painted dark colors, if exposed to direct sunlight.  
Note: See page 273 for important product details that may help with your purchase decision.





**S721**  
 ◆ ◆ ◆ ◆  
 2'8" x 6'8" ‡  
 2'10" x 6'8" ‡  
 3'0" x 6'8" ‡

**S8721**  
 ◆ ◆ ◆ ◆  
 2'8" x 8'0"  
 2'10" x 8'0"  
 3'0" x 8'0"

**S155SL**  
 ◆ ◆ ◆ ◆  
 12" x 6'8"  
 14" x 6'8"

**S85896SL**  
 ◆ ◆ ◆ ◆  
 12" x 8'0"  
 14" x 8'0"

**S5870SL**  
 ◆ ◆ ◆ ◆  
 10" x 6'8"  
 12" x 6'8" † ‡  
 14" x 6'8" † ‡

**S85934SL**  
 ◆ ◆ ◆ ◆  
 12" x 8'0"  
 14" x 8'0"

**S6091SL**  
 ◆ ◆ ◆ ◆  
 12" x 6'8"  
 14" x 6'8"

**S892SL**  
 ◆ ◆ ◆ ◆  
 12" x 8'0"  
 14" x 8'0"

**S292SL**  
 ◆ ◆ ◆ ◆  
 12" x 6'8"  
 14" x 6'8"

**S85922SL**  
 ◆ ◆ ◆ ◆  
 12" x 8'0"  
 14" x 8'0"

**WLHRT** ◆ ◆ ◆ ◆  
 3'0" door + (2) 12" sidelites  
 3'0" door + (2) 14" sidelites  
 Continuous / Boxed Sill Systems



**19720T** ◆ ◆ ◆ ◆  
 3'0" Door Only



**19730T** ◆ ◆ ◆ ◆  
 3'0" door + (2) 12" sidelites  
 Continuous Sill Systems Only

Transoms can be stained or painted to match a Fiber-Classic or Smooth-Star door system.

# Riserva™

Note: Product images show exterior side of door.

## Fiber-Classic® Mahogany



**FCM574**  
 X 6  
 2'8" x 6'8"  
 2'10" x 6'8"  
 3'0" x 6'8"

**FCM8574**  
 X 6  
 2'8" x 8'0"  
 2'10" x 8'0"  
 3'0" x 8'0"

**FCM571**  
 X X 6  
 2'6" x 6'8" † ‡  
 2'8" x 6'8" † ‡  
 2'10" x 6'8" † ‡  
 3'0" x 6'8" † ‡

**FCM8571**  
 X X 6  
 2'6" x 8'0"  
 2'8" x 8'0"  
 2'10" x 8'0"  
 3'0" x 8'0"

**FCM543**  
 X 6  
 2'8" x 6'8"  
 2'10" x 6'8"  
 3'0" x 6'8"

**FCM581**  
 X 6  
 2'8" x 6'8"  
 2'10" x 6'8"  
 3'0" x 6'8"

**FCM8581**  
 X 6  
 2'8" x 8'0"  
 2'10" x 8'0"  
 3'0" x 8'0"

**FCM575**  
 X 6  
 2'8" x 6'8"  
 2'10" x 6'8"  
 3'0" x 6'8"

**FCM8575**  
 X 6  
 2'8" x 8'0"  
 2'10" x 8'0"  
 3'0" x 8'0"

**FCM577**  
 X 6  
 2'8" x 6'8"  
 2'10" x 6'8"  
 3'0" x 6'8"

**FCM8577**  
 X 6  
 2'8" x 8'0"  
 2'10" x 8'0"  
 3'0" x 8'0"



**FCM508**  
 X 6  
 2'8" x 6'8"  
 2'10" x 6'8"  
 3'0" x 6'8"

**FCM506**  
 X  
 2'8" x 6'8"  
 2'10" x 6'8"  
 3'0" x 6'8"

**FCM572SL**  
 ◆ ◆ ◆ ◆  
 10" x 6'8"  
 12" x 6'8" † ‡  
 14" x 6'8" † ‡

**FCM8572SL**  
 ◆ ◆ ◆ ◆  
 12" x 8'0"  
 14" x 8'0"

**FCM8573SL**  
 X 6  
 12" x 8'0"  
 14" x 8'0"

**FCM545SL**  
 X 6  
 12" x 6'8"  
 14" x 6'8"

**FCM8545SL**  
 X 6  
 12" x 8'0"  
 14" x 8'0"

**FCM583SL**  
 X 6  
 12" x 6'8"  
 14" x 6'8"

**FCM8583SL**  
 X 6  
 12" x 8'0"  
 14" x 8'0"

Riserva Glass Continues on next page.

### Key

- No Stile Lines
- ◆ Black Nickel Caming (1D)
- ◆◆ Brushed Nickel Caming (1C)
- ◆◆ Brass Caming (1A)
- X Wrought Iron (1W)
- Vented Sidelite (No Impact)  
(6'6" & 6'8" only in 12" & 14")  
(8'0" only in 14")
- ⚙ WBDR Options
- ⚙ WBDR / HVHZ Options
- △ 6'6" Height Available
- ‡ 7'0" Height Available

### Optional Dentil Shelf\*



**4-Block Dentil Shelf**  
 Available for all Craftsman-style  
 Fiber-Classic Mahogany Collection doors.

## Fiber-Classic® Oak

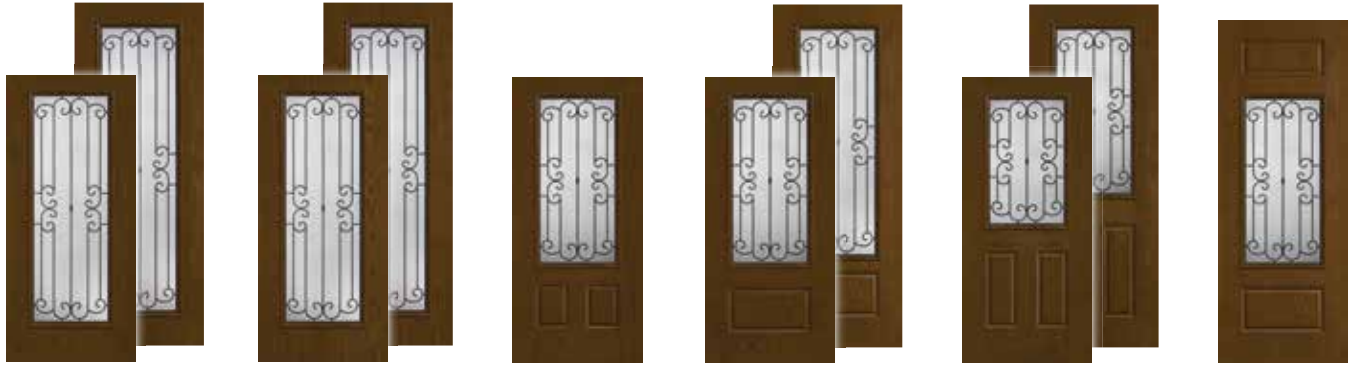

- |  |  |  |   |   |   |  |  |  |  |
|--|--|--|---|---|---|--|--|--|--|
| <b>FC574</b><br><b>X6</b><br>2'6" x 6'8"<br>2'8" x 6'8" ‡<br>2'10" x 6'8" ‡<br>3'0" x 6'8" ‡ | <b>FC8574</b><br><b>X6</b><br>2'8" x 8'0"<br>2'10" x 8'0"<br>3'0" x 8'0" | <b>FC571</b><br><b>X6</b><br>2'6" x 6'8" †‡<br>2'8" x 6'8" †‡<br>2'10" x 6'8" †‡<br>3'0" x 6'8" †‡ | <b>FC8571</b><br><b>X6</b><br>2'6" x 8'0"<br>2'8" x 8'0"<br>2'10" x 8'0"<br>3'0" x 8'0" | <b>FC543</b><br><b>X6</b><br>2'8" x 6'8"<br>2'10" x 6'8"<br>3'0" x 6'8" | <b>FC529</b><br><b>X6</b><br>2'8" x 6'8"<br>2'10" x 6'8"<br>3'0" x 6'8" | <b>FC8529</b><br><b>X6</b><br>2'8" x 8'0"<br>2'10" x 8'0"<br>3'0" x 8'0" | <b>FC581</b><br><b>X6</b><br>2'6" x 6'8"<br>2'8" x 6'8" ‡<br>2'10" x 6'8" ‡<br>3'0" x 6'8" ‡ | <b>FC8581</b><br><b>X6</b><br>2'8" x 8'0"<br>2'10" x 8'0"<br>3'0" x 8'0" | <b>FC8579</b><br><b>X6</b><br>2'8" x 8'0"<br>2'10" x 8'0"<br>3'0" x 8'0" |
|--|--|--|---|---|---|--|--|--|--|



- |  |  |   |   |   |  |   |  |
|--|--|---|---|---|--|---|--|
| <b>FC585</b><br><b>X</b><br>2'8" x 6'8"<br>2'10" x 6'8"<br>3'0" x 6'8" | <b>FC506</b><br><b>X</b><br>2'8" x 6'8"<br>2'10" x 6'8"<br>3'0" x 6'8" | <b>FC507</b><br><b>X6</b><br>2'8" x 6'8"<br>2'10" x 6'8"<br>3'0" x 6'8" | <b>FC549</b><br><b>X6</b><br>2'8" x 8'0"<br>2'10" x 8'0"<br>3'0" x 8'0" | <b>FC573SL</b><br><b>X6</b><br>10" x 6'8"<br>12" x 6'8"<br>14" x 6'8" | <b>FC8573SL</b><br><b>X6</b><br>12" x 8'0"<br>14" x 8'0" | <b>FC572SL</b><br><b>X6</b><br>12" x 6'8" †‡<br>14" x 6'8" †‡ | <b>FC8572SL</b><br><b>X6</b><br>12" x 8'0" †‡<br>14" x 8'0" †‡ |
|--|--|---|---|---|--|---|--|

## Smooth-Star®



- |   |  |   |  |
|---|--|---|--|
| <b>FC545SL</b><br><b>X6</b><br>12" x 6'8"<br>14" x 6'8" | <b>FC8545SL</b><br><b>X6</b><br>12" x 8'0"<br>14" x 8'0" | <b>FC583SL</b><br><b>X6</b><br>12" x 6'8"<br>14" x 6'8" | <b>FC8583SL</b><br><b>X6</b><br>12" x 8'0"<br>14" x 8'0" |
|---|--|---|--|

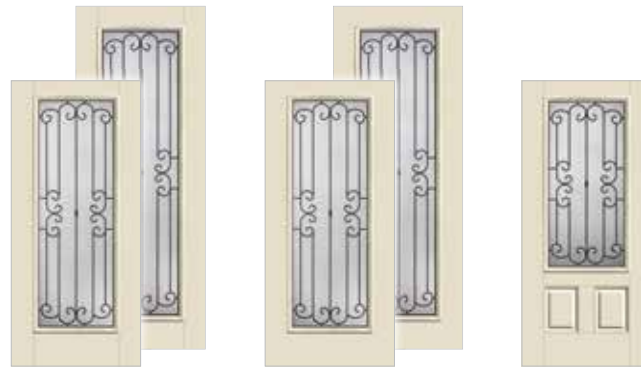

- |  |  |   |   |  |
|--|--|---|---|--|
| <b>S574</b><br><b>X6</b><br>2'6" x 6'8" †<br>2'8" x 6'8" †‡<br>2'10" x 6'8" †‡<br>3'0" x 6'8" †‡ | <b>S8574</b><br><b>X6</b><br>2'6" x 8'0"<br>2'8" x 8'0"<br>2'10" x 8'0"<br>3'0" x 8'0" | <b>S571</b><br><b>X6</b><br>2'6" x 6'8" †<br>2'8" x 6'8" †‡<br>2'10" x 6'8" †‡<br>3'0" x 6'8" †‡<br>3'6" x 6'8" | <b>S8571</b><br><b>X6</b><br>2'6" x 8'0"<br>2'8" x 8'0"<br>2'10" x 8'0"<br>3'0" x 8'0"<br>3'6" x 8'0" | <b>S543</b><br><b>X6</b><br>2'8" x 6'8"<br>2'10" x 6'8"<br>3'0" x 6'8" |
|--|--|---|---|--|

\*Not recommended for use behind storm doors or to be painted dark colors, if exposed to direct sunlight.  
Note: See page 273 for important product details that may help with your purchase decision.



**S529**  
**X 6**  
 2'8" x 6'8"  
 2'10" x 6'8"  
 3'0" x 6'8"

**S8529**  
**X 6**  
 2'8" x 8'0"  
 2'10" x 8'0"  
 3'0" x 8'0"



**S581**  
**X 6**  
 2'6" x 6'8"  
 2'8" x 6'8" ‡  
 2'10" x 6'8" ‡  
 3'0" x 6'8" ‡

**S8581**  
**X 6**  
 2'8" x 8'0"  
 2'10" x 8'0"  
 3'0" x 8'0"



**S575**  
**X 6**  
 2'6" x 6'8"  
 2'8" x 6'8" ‡  
 2'10" x 6'8" ‡  
 3'0" x 6'8" ‡



**S577**  
**X 6**  
 2'8" x 6'8"  
 2'10" x 6'8"  
 3'0" x 6'8"



**S579**  
**X 6**  
 2'8" x 6'8"  
 2'10" x 6'8"  
 3'0" x 6'8"

**S8579**  
**X 6**  
 2'8" x 8'0"  
 2'10" x 8'0"  
 3'0" x 8'0"



**S585**  
**X**  
 2'8" x 6'8"  
 2'10" x 6'8"  
 3'0" x 6'8"



**S508**  
**X 6**  
 2'8" x 6'8"  
 2'10" x 6'8"  
 3'0" x 6'8"

**S8508**  
**X 6**  
 2'8" x 8'0"  
 2'10" x 8'0"  
 3'0" x 8'0"



**S506**  
**X**  
 2'8" x 6'8"  
 2'10" x 6'8"  
 3'0" x 6'8"



**S507**  
**X 6**  
 2'8" x 6'8"  
 2'10" x 6'8"  
 3'0" x 6'8"



**S549**  
**X 6**  
 2'8" x 8'0"  
 2'10" x 8'0"  
 3'0" x 8'0"



**S573SL**  
**X 6**  
 12" x 6'8"  
 14" x 6'8"



**S8573SL**  
**X 6**  
 12" x 8'0"  
 14" x 8'0"



**S572SL**  
**X X 6**  
 10" x 6'8"  
 12" x 6'8" ‡ †  
 14" x 6'8" ‡ †

**S8572SL**  
**X X 6**  
 12" x 8'0"  
 14" x 8'0"



**S545SL**  
**X 6**  
 12" x 6'8"  
 14" x 6'8"



**S8545SL**  
**X 6**  
 12" x 8'0"  
 14" x 8'0"



**RSRT**  
**X**  
 3'0" door + (2) 12" sidelites  
 Continuous Sill Systems Only

**S583SL**  
**X 6**  
 12" x 6'8"  
 14" x 6'8"

**S8583SL**  
**X 6**  
 12" x 8'0"  
 14" x 8'0"

Transoms can be stained or painted to match a Fiber-Classic or Smooth-Star door system.

### Key

- No Stile Lines
- X Wrought Iron (1W)
- Vented Sidelite (No Impact)  
 (6'6" & 6'8" only in 12" & 14")  
 (8'0" only in 14")
- 6 WBDR Options
- 6 WBDR / HVHZ Options
- △ 6'6" Height Available
- ‡ 7'0" Height Available

### Optional Dentil Shelf\*





# Concorde™

## Fiber-Classic® Mahogany



## Fiber-Classic® Oak



Note: See page 273 for important product details that may help with your purchase decision.



|   |   |   |   |   |   |   |
|---|---|---|---|---|---|---|
| <b>FC913</b><br>◆ ■ ■ ■<br>2'8" x 6'8"<br>2'10" x 6'8"<br>3'0" x 6'8" | <b>FC916</b><br>◆ ■ ■ ■<br>2'8" x 6'8"<br>2'10" x 6'8"<br>3'0" x 6'8" | <b>FC915</b><br>◆ ■ ■ ■<br>2'8" x 6'8"<br>2'10" x 6'8"<br>3'0" x 6'8" | <b>FC797</b><br>◆ ■ ■ ■<br>2'8" x 6'8"<br>2'10" x 6'8"<br>3'0" x 6'8" | <b>FC914</b><br>◆ ■ ■ ■<br>2'8" x 6'8"<br>2'10" x 6'8"<br>3'0" x 6'8" | <b>FC80947</b><br>◆ ■ ■ ■ 6<br>2'8" x 6'8"<br>2'10" x 6'8"<br>3'0" x 6'8" | <b>FC86247</b><br>◆ ■ ■ ■ 6<br>2'8" x 8'0"<br>2'10" x 8'0"<br>3'0" x 8'0" |
|---|---|---|---|---|---|---|

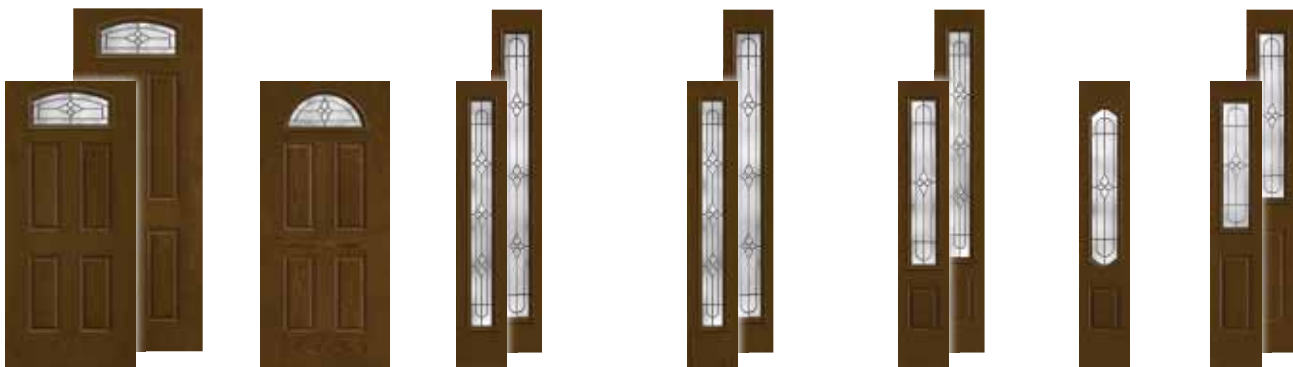

|   |  |  |   |  |   |   |   |  |   |   |  |
|---|--|--|---|--|---|---|---|--|---|---|--|
| <b>FC735</b><br>◆ ■ ■ ■<br>2'8" x 6'8" ‡<br>2'10" x 6'8" ‡<br>3'0" x 6'8" ‡ | <b>FC8735</b><br>◆ ■ ■ ■<br>2'8" x 8'0"<br>2'10" x 8'0"<br>3'0" x 8'0" | <b>FC917</b><br>◆ ■ ■ ■<br>2'6" x 6'8"<br>2'8" x 6'8"<br>2'10" x 6'8"<br>3'0" x 6'8" | <b>FC910SL</b><br>◆ ■ ■ ■ 6<br>10" x 6'8"<br>12" x 6'8"<br>14" x 6'8" | <b>81928PSL</b><br>◆ ■ ■ ■ 6<br>12" x 8'0"<br>14" x 8'0" | <b>FC809SL</b><br>■ ■ ■ ■ 6<br>12" x 6'8" ‡<br>14" x 6'8" ‡ | <b>81928SL</b><br>■ ■ ■ ■ 6<br>12" x 8'0"<br>14" x 8'0" | <b>FC912SL</b><br>◆ ■ ■ ■ 6<br>12" x 6'8"<br>14" x 6'8" | <b>81960PSL</b><br>◆ ■ ■ ■ 6<br>12" x 8'0"<br>14" x 8'0" | <b>FC916SL</b><br>◆ ■ ■ ■<br>12" x 6'8"<br>14" x 6'8" | <b>FC911SL</b><br>◆ ■ ■ ■ 6<br>12" x 6'8"<br>14" x 6'8" | <b>81942PSL</b><br>◆ ■ ■ ■ 6<br>12" x 8'0"<br>14" x 8'0" |
|---|--|--|---|--|---|---|---|--|---|---|--|

## Smooth-Star®



|  |   |   |  |  |   |  |   |   |  |
|--|---|---|--|--|---|--|---|---|--|
| <b>S6090</b><br>◆ ■ ■ ■ 6<br>2'6" x 6'8" ‡<br>2'8" x 6'8" ‡<br>2'10" x 6'8" ‡<br>3'0" x 6'8" ‡ | <b>S85895</b><br>◆ ■ ■ ■ 6<br>2'6" x 8'0"<br>2'8" x 8'0"<br>2'10" x 8'0"<br>3'0" x 8'0" | <b>S6095</b><br>◆ ■ ■ ■ 6<br>2'6" x 6'8" ‡<br>2'8" x 6'8" ‡<br>2'10" x 6'8" ‡<br>3'0" x 6'8" ‡<br>3'6" x 6'8" | <b>S820</b><br>■ ■ ■ ■ 6<br>2'6" x 8'0"<br>2'8" x 8'0"<br>2'10" x 8'0"<br>3'0" x 8'0"<br>3'6" x 8'0" | <b>S912</b><br>◆ ■ ■ ■ 6<br>2'8" x 6'8"<br>2'10" x 6'8"<br>3'0" x 6'8" | <b>S97</b><br>◆ ■ ■ ■ 6<br>2'8" x 6'8"<br>2'10" x 6'8"<br>3'0" x 6'8" | <b>S85902</b><br>◆ ■ ■ ■ 6<br>2'8" x 8'0"<br>2'10" x 8'0"<br>3'0" x 8'0" | <b>S426</b><br>◆ ■ ■ ■ 6<br>2'6" x 6'8"<br>2'8" x 6'8" ‡<br>2'10" x 6'8" ‡<br>3'0" x 6'8" ‡ | <b>S81942P</b><br>◆ ■ ■ ■ 6<br>2'8" x 8'0"<br>2'10" x 8'0"<br>3'0" x 8'0" | <b>S6026</b><br>◆ ■ ■ ■ 6<br>2'6" x 6'8"<br>2'8" x 6'8" ‡<br>2'10" x 6'8" ‡<br>3'0" x 6'8" ‡ |
|--|---|---|--|--|---|--|---|---|--|

Concorde Glass *Continues on next page.*

### Key

- No Stile Lines
- ◆ Black Nickel Caming (1D)
- ■ ■ ■ Brushed Nickel Caming (1C)
- ◆ ■ ■ ■ Brass Caming (1A)
- Vented Sidelite (No Impact)  
(6'6" & 6'8" only in 12" & 14")  
(8'0" only in 14")
- △ 6'6" Height Available
- ‡ 7'0" Height Available
- 6 WBDR Options
- 6 WBDR / HVHZ Options



**S6046**  
 ◆ ◆ ◆ ◆ ◆ ◆  
 2'8" x 6'8"  
 2'10" x 6'8"  
 3'0" x 6'8"

**S37**  
 ◆ ◆ ◆ ◆ ◆ ◆  
 2'8" x 6'8"  
 2'10" x 6'8"  
 3'0" x 6'8"

**S837**  
 ◆ ◆ ◆ ◆ ◆ ◆  
 2'8" x 8'0"  
 2'10" x 8'0"  
 3'0" x 8'0"

**S450**  
 ◆ ◆ ◆ ◆ ◆ ◆  
 2'8" x 6'8"  
 2'10" x 6'8"  
 3'0" x 6'8"

**S430**  
 ◆ ◆ ◆ ◆ ◆ ◆  
 2'8" x 6'8"  
 2'10" x 6'8"  
 3'0" x 6'8"

**S400**  
 ◆ ◆ ◆ ◆ ◆ ◆  
 2'6" x 6'8" †  
 2'8" x 6'8" † ‡  
 2'10" x 6'8" † ‡  
 3'0" x 6'8" † ‡  
 3'6" x 6'8" †

**S773**  
 ◆ ◆ ◆ ◆ ◆ ◆  
 2'8" x 6'8"  
 2'10" x 6'8"  
 3'0" x 6'8"

**S6084**  
 ◆ ◆ ◆ ◆ ◆ ◆  
 2'8" x 6'8"  
 2'10" x 6'8"  
 3'0" x 6'8"



**S1000**  
 ◆ ◆ ◆ ◆ ◆ ◆  
 2'8" x 6'8"  
 2'10" x 6'8"  
 3'0" x 6'8"

**S17**  
 ◆ ◆ ◆ ◆ ◆ ◆  
 2'8" x 6'8"  
 2'10" x 6'8"  
 3'0" x 6'8"

**S9347**  
 ◆ ◆ ◆ ◆ ◆ ◆  
 2'8" x 6'8"  
 2'10" x 6'8"  
 3'0" x 6'8"

**S83147**  
 ◆ ◆ ◆ ◆ ◆ ◆  
 2'8" x 8'0"  
 2'10" x 8'0"  
 3'0" x 8'0"

**S735**  
 ◆ ◆ ◆ ◆ ◆ ◆  
 2'8" x 6'8" ‡  
 2'10" x 6'8" ‡  
 3'0" x 6'8" ‡

**S8735**  
 ◆ ◆ ◆ ◆ ◆ ◆  
 2'8" x 8'0"  
 2'10" x 8'0"  
 3'0" x 8'0"

**S454**  
 ◆ ◆ ◆ ◆ ◆ ◆  
 2'8" x 6'8"  
 2'10" x 6'8"  
 3'0" x 6'8"

**S416SL**  
 ◆ ◆ ◆ ◆ ◆ ◆  
 12" x 6'8"  
 14" x 6'8"

**S85895SL**  
 ◆ ◆ ◆ ◆ ◆ ◆  
 12" x 8'0"  
 14" x 8'0"



**S4070SL**  
 ◆ ◆ ◆ ◆ ◆ ◆  
 10" x 6'8"  
 12" x 6'8" † ‡  
 14" x 6'8" † ‡

**S85930SL**  
 ◆ ◆ ◆ ◆ ◆ ◆  
 12" x 8'0"  
 14" x 8'0"

**S757SL**  
 ◆ ◆ ◆ ◆ ◆ ◆  
 12" x 6'8"  
 14" x 6'8"

**S85902SL**  
 ◆ ◆ ◆ ◆ ◆ ◆  
 12" x 8'0"  
 14" x 8'0"

**S767SL**  
 ◆ ◆ ◆ ◆ ◆ ◆  
 12" x 6'8"  
 14" x 6'8"

**S430SL**  
 ◆ ◆ ◆ ◆ ◆ ◆  
 12" x 6'8"  
 14" x 6'8"

**S85920SL**  
 ◆ ◆ ◆ ◆ ◆ ◆  
 12" x 8'0"  
 14" x 8'0"

**S450SL**  
 ◆ ◆ ◆ ◆ ◆ ◆  
 12" x 6'8"  
 14" x 6'8"

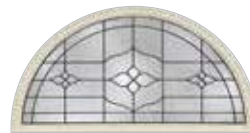

**CNVRT**  
 ◆ ◆ ◆ ◆ ◆ ◆  
 3'0" door + (2) 12" sidelites  
 3'0" door + (2) 14" sidelites  
 Continuous / Boxed Sill Systems



**CNRT**  
 ◆ ◆ ◆ ◆ ◆ ◆  
 3'0" door + (2) 12" sidelites  
 3'0" door + (2) 14" sidelites  
 Continuous Sill Systems Only

Transoms can be stained or painted to match a Fiber-Classic or Smooth-Star door system.



## Fiber-Classic® Mahogany



**FCM148**  
◆ ■ ■ 6  
2'8" x 6'8" ‡  
2'10" x 6'8" ‡  
3'0" x 6'8"



**FCM626**  
■ ◆ ■ ■ 6  
2'8" x 6'8" △ ‡  
2'10" x 6'8" △ ‡  
3'0" x 6'8" △ ‡



**FCM156**  
◆ ■ ■ 6  
2'8" x 6'8" ‡  
2'10" x 6'8" ‡  
3'0" x 6'8"



**FCM149** | **FCM8149**  
◆ ■ ■ 6 | ◆ ■ ■ 6  
2'8" x 6'8" | 2'8" x 8'0"  
2'10" x 6'8" | 2'10" x 8'0"  
3'0" x 6'8" | 3'0" x 8'0"



**FCM6036**  
◆ ■ ■ 6  
2'8" x 6'8" ‡  
2'10" x 6'8" ‡  
3'0" x 6'8"



**FCM6056**  
◆ ■ ■ 6  
2'8" x 6'8" ‡  
2'10" x 6'8" ‡  
3'0" x 6'8"



**FCM151**  
■ ■ ◆  
2'8" x 6'8" ‡  
2'10" x 6'8" ‡  
3'0" x 6'8"



**FCM789**  
◆ ■ ■  
2'8" x 6'8" ‡  
2'10" x 6'8" ‡  
3'0" x 6'8"



**FCM150**  
◆ ■ ■  
2'8" x 6'8" ‡  
2'10" x 6'8" ‡  
3'0" x 6'8"



**FCM813SL**  
■ ◆ ■ ■ 6  
10" x 6'8" ‡  
12" x 6'8" △ ‡  
14" x 6'8" △ ‡



**FCM1442SL**  
◆ ■ ■ 6  
12" x 6'8" ‡  
14" x 6'8" ‡



**FCM8107SL**  
◆ ■ ■ 6  
12" x 8'0" ‡  
14" x 8'0" ‡

**FCM149SL**  
◆ ■ ■ 6  
12" x 6'8" ‡  
14" x 6'8" ‡

**FCM867SL**  
◆ ■ ■ 6  
12" x 8'0" ‡  
14" x 8'0" ‡

## Fiber-Classic® Oak



**FC148**  
◆ ■ ■ 6  
2'8" x 6'8" ‡  
2'10" x 6'8" ‡  
3'0" x 6'8" ‡



**FC626**  
■ ◆ ■ ■ 6  
2'8" x 6'8" △ ‡  
2'10" x 6'8" △ ‡  
3'0" x 6'8" △ ‡



**FC20042**  
◆ ■ ■ 6  
2'8" x 6'8" ‡  
2'10" x 6'8" ‡  
3'0" x 6'8"



**81961P**  
◆ ■ ■ 6  
2'8" x 8'0" ‡  
2'10" x 8'0" ‡  
3'0" x 8'0"



**FC156**  
◆ ■ ■ 6  
2'8" x 6'8" ‡  
2'10" x 6'8" ‡  
3'0" x 6'8"



**FC149**  
◆ ■ ■ 6  
2'6" x 6'8" ‡  
2'8" x 6'8" ‡  
2'10" x 6'8" ‡  
3'0" x 6'8" ‡



**FC8149**  
◆ ■ ■ 6  
2'8" x 8'0" ‡  
2'10" x 8'0" ‡  
3'0" x 8'0"



**FC89701**  
◆ ■ ■ 6  
2'8" x 8'0" ‡  
2'10" x 8'0" ‡  
3'0" x 8'0"



**FC152**  
◆ ■ ■  
2'8" x 6'8" ‡  
2'10" x 6'8" ‡  
3'0" x 6'8"

Kensington Glass *Continues on next page.*

### Key

- No Stile Lines
- ◆ Black Nickel Caming (1D)
- ■ Brushed Nickel Caming (1C)
- ◆ ■ Brass Caming (1A)
- Vented Sidelite (No Impact)  
(6'6" & 6'8" only in 12" & 14")  
(8'0" only in 14")
- 6 WBDR Options
- 6 WBDR / HVHZ Options
- △ 6'6" Height Available
- ‡ 7'0" Height Available



**FC709**  
◆ ◆  
2'8" x 6'8"  
2'10" x 6'8"  
3'0" x 6'8"



**FC151**  
◆ ◆  
2'8" x 6'8"  
2'10" x 6'8"  
3'0" x 6'8"



**FC798**  
◆ ◆  
2'8" x 6'8"  
2'10" x 6'8"  
3'0" x 6'8"



**FC150**  
◆ ◆  
2'8" x 6'8"  
2'10" x 6'8"  
3'0" x 6'8"



**FC80942**  
◆ ◆ 6  
2'8" x 6'8"  
2'10" x 6'8"  
3'0" x 6'8"



**FC86242**  
◆ ◆ 6  
2'8" x 8'0"  
2'10" x 8'0"  
3'0" x 8'0"



**FC148SL**  
◆ ◆ 6  
10" x 6'8"  
12" x 6'8"  
14" x 6'8"



**FC813SL**  
◆ ◆ ◆ 6  
12" x 6'8" Δ ‡  
14" x 6'8" Δ ‡

## Smooth-Star®



**FC1442SL**  
◆ ◆ 6  
12" x 6'8"  
14" x 6'8"



**81961PSL**  
◆ ◆ 6  
12" x 8'0"  
14" x 8'0"

**FC149SL**  
◆ ◆ 6  
12" x 6'8"  
14" x 6'8"

**FC8867SL**  
◆ ◆ 6  
12" x 8'0"  
14" x 8'0"



**S160**  
◆ ◆ 6  
2'8" x 6'8" ‡  
2'10" x 6'8" Δ ‡  
3'0" x 6'8" Δ ‡



**S626**  
◆ ◆ ◆ 6  
2'8" x 6'8" Δ ‡  
2'10" x 6'8" Δ ‡  
3'0" x 6'8" Δ ‡  
3'6" x 6'8"



**S20042**  
◆ ◆ 6  
2'8" x 6'8"  
2'10" x 6'8"  
3'0" x 6'8"



**S902**  
◆ ◆ 6  
2'8" x 8'0"  
2'10" x 8'0"  
3'0" x 8'0"

**S156**  
◆ ◆ 6  
2'8" x 6'8"  
2'10" x 6'8"  
3'0" x 6'8"



**S161**  
◆ ◆ 6  
2'8" x 6'8" ‡  
2'10" x 6'8" ‡  
3'0" x 6'8" ‡



**S8149**  
◆ ◆ 6  
2'8" x 8'0"  
2'10" x 8'0"  
3'0" x 8'0"



**S6036**  
◆ ◆ 6  
2'8" x 6'8" ‡  
2'10" x 6'8" ‡  
3'0" x 6'8" ‡



**S6056**  
◆ ◆ 6  
2'8" x 6'8"  
2'10" x 6'8"  
3'0" x 6'8"



**S43**  
◆ ◆ 6  
2'8" x 6'8"  
2'10" x 6'8"  
3'0" x 6'8"



**S89701**  
◆ ◆ 6  
2'8" x 8'0"  
2'10" x 8'0"  
3'0" x 8'0"



**S162**  
◆ ◆  
2'8" x 6'8"  
2'10" x 6'8"  
3'0" x 6'8"



**S709**  
◆ ◆  
2'8" x 6'8"  
2'10" x 6'8"  
3'0" x 6'8"



**S163**  
 ◆ ■ ■ ■  
 2'8" x 6'8"  
 2'10" x 6'8"  
 3'0" x 6'8"



**S1001**  
 ◆ ■ ■ ■  
 2'8" x 6'8"  
 2'10" x 6'8"  
 3'0" x 6'8"



**S6119**  
 ◆ ■ ■ ■  
 2'8" x 6'8"  
 2'10" x 6'8"  
 3'0" x 6'8"



**S9342**  
 ◆ ■ ■ 6  
 2'8" x 6'8"  
 2'10" x 6'8"  
 3'0" x 6'8"



**S83142**  
 ◆ ■ ■ 6  
 2'8" x 8'0"  
 2'10" x 8'0"  
 3'0" x 8'0"



**S160SL**  
 ◆ ■ ■ 6  
 12" x 6'8"  
 14" x 6'8"



**S6132SL**  
 ■ ◆ ◆ ■ ■ 6  
 10" x 6'8"  
 12" x 6'8" ▲ †  
 14" x 6'8" ▲ †



**S1442SL**  
 ◆ ■ ■ 6  
 12" x 6'8"  
 14" x 6'8"



**S902SL**  
 ◆ ■ ■ 6  
 12" x 8'0"  
 14" x 8'0"

**S161SL**  
 ◆ ■ ■ 6  
 12" x 6'8"  
 14" x 6'8"

**S867SL**  
 ◆ ■ ■ 6  
 12" x 8'0"  
 14" x 8'0"



**KNRT** ◆ ■ ■ ■  
 3'0" door + (2) 12" sidelites  
 3'0" door + (2) 14" sidelites  
 Continuous Sill Systems Only

Transoms can be stained or painted to match a Fiber-Classic or Smooth-Star door system.



**Key**

- No Stile Lines
- ◆ Black Nickel Caming (1D)
- ■ ■ Brushed Nickel Caming (1C)
- Vented Sidelite (No Impact)  
 (6'6" & 6'8" only in 12" & 14")  
 (8'0" only in 14")
- 6 WBDR Options
- 6 WBDR / HVHZ Options
- ▲ 6'6" Height Available
- † 7'0" Height Available



## Fiber-Classic® Mahogany



- |   |  |   |   |   |   |  |   |   |
|---|--|---|---|---|---|--|---|---|
| <b>FCM1652</b><br>◆ 6<br>2'8" x 6'8"<br>2'10" x 6'8"<br>3'0" x 6'8" | <b>FCM81652</b><br>◆ 6<br>2'8" x 8'0"<br>2'10" x 8'0"<br>3'0" x 8'0" | <b>FCM1651</b><br>◆ 6<br>2'4" x 6'8" †<br>2'6" x 6'8" † ‡<br>2'8" x 6'8" † ‡<br>2'10" x 6'8" † ‡<br>3'0" x 6'8" † ‡ | <b>FCM81651</b><br>◆ 6<br>2'6" x 8'0"<br>2'8" x 8'0"<br>2'10" x 8'0"<br>3'0" x 8'0" | <b>FCM1647</b><br>◆ 6<br>2'8" x 6'8"<br>2'10" x 6'8"<br>3'0" x 6'8" | <b>FCM1654</b><br>◆ 6<br>2'8" x 6'8"<br>2'10" x 6'8"<br>3'0" x 6'8" | <b>FCM81654</b><br>◆ 6<br>2'8" x 8'0"<br>2'10" x 8'0"<br>3'0" x 8'0" | <b>FCM1656</b><br>◆ 6<br>2'8" x 6'8"<br>2'10" x 6'8"<br>3'0" x 6'8" | <b>FCM1658</b><br>◆ 6<br>2'8" x 6'8"<br>2'10" x 6'8"<br>3'0" x 6'8" |
|---|--|---|---|---|---|--|---|---|



- |   |   |  |   |  |  |   |  |   |  |
|---|---|--|---|--|--|---|--|---|--|
| <b>FCM1650</b><br>◆ 6<br>2'8" x 6'8"<br>2'10" x 6'8"<br>3'0" x 6'8" | <b>FCM1645</b><br>◆<br>2'8" x 6'8"<br>2'10" x 6'8"<br>3'0" x 6'8" | <b>FCM81645</b><br>◆<br>2'8" x 8'0"<br>2'10" x 8'0"<br>3'0" x 8'0" | <b>FCM1651SL</b><br>◆ 6<br>10" x 6'8"<br>12" x 6'8" † ‡<br>14" x 6'8" † ‡ | <b>FCM81651SL</b><br>◆ 6<br>12" x 8'0"<br>14" x 8'0" | <b>FCM81652SL</b><br>◆ 6<br>12" x 8'0"<br>14" x 8'0" | <b>FCM1646SL</b><br>◆ 6<br>12" x 6'8"<br>14" x 6'8" | <b>FCM81646SL</b><br>◆ 6<br>12" x 8'0"<br>14" x 8'0" | <b>FCM1656SL</b><br>◆ 6<br>12" x 6'8"<br>14" x 6'8" | <b>FCM81654SL</b><br>◆ 6<br>12" x 8'0"<br>14" x 8'0" |
|---|---|--|---|--|--|---|--|---|--|

## Fiber-Classic® Oak



- |   |   |  |  |  |  |   |   |   |
|---|---|--|--|--|--|---|---|---|
| <b>FC1652</b><br>◆ 6<br>2'6" x 6'8"<br>2'8" x 6'8" †<br>2'10" x 6'8" †<br>3'0" x 6'8" † | <b>FC81652</b><br>◆ 6<br>2'8" x 8'0"<br>2'10" x 8'0"<br>3'0" x 8'0" | <b>FC1651</b><br>◆ 6<br>2'4" x 6'8" †<br>2'6" x 6'8" † ‡<br>2'8" x 6'8" † ‡<br>2'10" x 6'8" † ‡<br>3'0" x 6'8" † ‡ | <b>FC81651</b><br>◆ 6<br>2'6" x 8'0"<br>2'8" x 8'0"<br>2'10" x 8'0"<br>3'0" x 8'0" | <b>FC1647</b><br>◆ 6<br>2'8" x 6'8"<br>2'10" x 6'8"<br>3'0" x 6'8" | <b>FC1646</b><br>◆ 6<br>2'8" x 6'8"<br>2'10" x 6'8"<br>3'0" x 6'8" | <b>FC81646</b><br>◆ 6<br>2'8" x 8'0"<br>2'10" x 8'0"<br>3'0" x 8'0" | <b>FC1654</b><br>◆ 6<br>2'6" x 6'8"<br>2'8" x 6'8" †<br>2'10" x 6'8" † ‡<br>3'0" x 6'8" † ‡ | <b>FC81654</b><br>◆ 6<br>2'8" x 8'0"<br>2'10" x 8'0"<br>3'0" x 8'0" |
|---|---|--|--|--|--|---|---|---|

\*Not recommended for use behind storm doors or to be painted dark colors, if exposed to direct sunlight.  
Note: See page 273 for important product details that may help with your purchase decision.



|   |  |   |   |   |  |  |   |  |   |
|---|--|---|---|---|--|--|---|--|---|
| <b>FC81653</b><br>◆ 6<br>2'8" x 8'0"<br>2'10" x 8'0"<br>3'0" x 8'0" | <b>FC1655</b><br>◆ 6<br>2'8" x 6'8"<br>2'10" x 6'8"<br>3'0" x 6'8" | <b>FC81649</b><br>◆ 6<br>2'8" x 8'0"<br>2'10" x 8'0"<br>3'0" x 8'0" | <b>FC1645</b><br>◆<br>2'6" x 6'8" ‡<br>2'8" x 6'8" ‡<br>2'10" x 6'8" ‡<br>3'0" x 6'8" ‡ | <b>FC81645</b><br>◆<br>2'8" x 8'0"<br>2'10" x 8'0"<br>3'0" x 8'0" | <b>FC1661</b><br>◆<br>2'8" x 6'8"<br>2'10" x 6'8"<br>3'0" x 6'8" | <b>FC1652SL</b><br>◆ 6<br>10" x 6'8"<br>12" x 6'8"<br>14" x 6'8" | <b>FC81652SL</b><br>◆ 6<br>12" x 8'0"<br>14" x 8'0" | <b>FC1651SL</b><br>◆ 6<br>12" x 6'8" ‡<br>14" x 6'8" ‡ | <b>FC81651SL</b><br>◆ 6<br>12" x 8'0" ‡<br>14" x 8'0" ‡ |
|---|--|---|---|---|--|--|---|--|---|

## Smooth-Star®



|  |   |  |   |
|--|---|--|---|
| <b>FC1646SL</b><br>◆ 6<br>12" x 6'8"<br>14" x 6'8" | <b>FC81646SL</b><br>◆ 6<br>12" x 8'0"<br>14" x 8'0" | <b>FC1656SL</b><br>◆ 6<br>12" x 6'8"<br>14" x 6'8" | <b>FC81654SL</b><br>◆ 6<br>12" x 8'0"<br>14" x 8'0" |
|--|---|--|---|



|  |   |  |  |   |   |  |
|--|---|--|--|---|---|--|
| <b>S1652</b><br>◆ 6<br>2'6" x 6'8" △<br>2'8" x 6'8" △ ‡<br>2'10" x 6'8" △ ‡<br>3'0" x 6'8" △ ‡ | <b>S81652</b><br>◆ 6<br>2'6" x 8'0"<br>2'8" x 8'0"<br>2'10" x 8'0"<br>3'0" x 8'0" | <b>S1651</b><br>◆ 6<br>2'4" x 6'8" △<br>2'6" x 6'8" △<br>2'8" x 6'8" △ ‡<br>2'10" x 6'8" △ ‡<br>3'0" x 6'8" △ ‡<br>3'6" x 6'8" | <b>S81651</b><br>◆ 6<br>2'6" x 8'0"<br>2'8" x 8'0"<br>2'10" x 8'0"<br>3'0" x 8'0"<br>3'6" x 8'0" | <b>S1647</b><br>◆ 6<br>2'8" x 6'8"<br>2'10" x 6'8"<br>3'0" x 6'8" | <b>S1646</b><br>◆ 6<br>2'8" x 6'8"<br>2'10" x 6'8"<br>3'0" x 6'8" | <b>S81646</b><br>◆ 6<br>2'8" x 8'0"<br>2'10" x 8'0"<br>3'0" x 8'0" |
|--|---|--|--|---|---|--|



|  |  |  |   |   |  |   |  |   |
|--|--|--|---|---|--|---|--|---|
| <b>S1654</b><br>◆ 6<br>2'6" x 6'8"<br>2'8" x 6'8" ‡<br>2'10" x 6'8" ‡<br>3'0" x 6'8" ‡ | <b>S81654</b><br>◆ 6<br>2'8" x 8'0"<br>2'10" x 8'0"<br>3'0" x 8'0" | <b>S1656</b><br>◆ 6<br>2'6" x 6'8"<br>2'8" x 6'8" ‡<br>2'10" x 6'8" ‡<br>3'0" x 6'8" ‡ | <b>S1658</b><br>◆ 6<br>2'8" x 6'8"<br>2'10" x 6'8"<br>3'0" x 6'8" | <b>S1653</b><br>◆ 6<br>2'8" x 6'8"<br>2'10" x 6'8"<br>3'0" x 6'8" | <b>S81653</b><br>◆ 6<br>2'8" x 8'0"<br>2'10" x 8'0"<br>3'0" x 8'0" | <b>S1650</b><br>◆ 6<br>2'8" x 6'8"<br>2'10" x 6'8"<br>3'0" x 6'8" | <b>S81650</b><br>◆ 6<br>2'8" x 8'0"<br>2'10" x 8'0"<br>3'0" x 8'0" | <b>S1655</b><br>◆ 6<br>2'8" x 6'8"<br>2'10" x 6'8"<br>3'0" x 6'8" |
|--|--|--|---|---|--|---|--|---|

Axis Glass *Continues on next page.*

### Key

- No Stile Lines
- ◆ Black Nickel Caming (1D)
- Vented Sidelite (No Impact)  
(6'6" & 6'8" only in 12" & 14")  
(8'0" only in 14")

- 6 WBDR Options
- 6 WBDR / HVHZ Options
- △ 6'6" Height Available
- ‡ 7'0" Height Available

### Optional Dentil Shelves\*

-  4-Block Dentil Shelf  
Available for all Craftsman-style  
Fiber-Classic Mahogany Collection doors.
-  4-Block Dentil Shelf  
Available for all Craftsman-style  
Smooth-Star doors.

**Axis™ Glass** *Continued*



**S81649**  
 ◆ 6  
 2'8" x 8'0"  
 2'10" x 8'0"  
 3'0" x 8'0"



**S1645**  
 ◆  
 2'6" x 6'8"  
 2'8" x 6'8" ‡  
 2'10" x 6'8" ‡  
 3'0" x 6'8" ‡



**S81645**  
 ◆  
 2'6" x 8'0"  
 2'8" x 8'0"  
 2'10" x 8'0"  
 3'0" x 8'0"

**S1661**  
 ◆  
 2'8" x 6'8"  
 2'10" x 6'8"  
 3'0" x 6'8"



**S1652SL**  
 ◆ 6  
 12" x 6'8"  
 14" x 6'8"



**S81652SL**  
 ◆ 6  
 12" x 8'0"  
 14" x 8'0"



**S1651SL**  
 ◆ ◆ ◆ 6  
 10" x 6'8"  
 12" x 6'8" ‡ ‡  
 14" x 6'8" ‡ ‡



**S81651SL**  
 ◆ ◆ ◆ 6  
 12" x 8'0"  
 14" x 8'0"



**S1646SL**  
 ◆ 6  
 12" x 6'8"  
 14" x 6'8"



**S81646SL**  
 ◆ 6  
 12" x 8'0"  
 14" x 8'0"



**AXRT** ◆  
 3'0" door + (2) 12" sidelites  
 3'0" door + (2) 14" sidelites  
 Continuous Sill Systems Only

**S1656SL**  
 ◆ 6  
 12" x 6'8"  
 14" x 6'8"

**S81654SL**  
 ◆ 6  
 12" x 8'0"  
 14" x 8'0"

Transoms can be stained or painted to match a Fiber-Classic or Smooth-Star door system.





# Frosted Images®

## Fiber-Classic® Mahogany



- |   |   |   |   |  |   |  |   |   |
|---|---|---|---|--|---|--|---|---|
| <b>FCM11</b><br>6<br>2'8" x 6'8"<br>2'10" x 6'8"<br>3'0" x 6'8" | <b>FCM8113</b><br>6<br>2'8" x 8'0"<br>2'10" x 8'0"<br>3'0" x 8'0" | <b>FCM669</b><br>6<br>2'6" x 6'8" †‡<br>2'8" x 6'8" †‡<br>2'10" x 6'8" †‡<br>3'0" x 6'8" †‡ | <b>FCM813</b><br>6<br>2'6" x 8'0"<br>2'8" x 8'0"<br>2'10" x 8'0"<br>3'0" x 8'0" | <b>FCM763</b><br>6<br>2'8" x 6'8"<br>2'10" x 6'8"<br>3'0" x 6'8" | <b>FCM66</b><br>6<br>2'8" x 6'8"<br>2'10" x 6'8"<br>3'0" x 6'8" | <b>FCM895</b><br>6<br>2'8" x 8'0"<br>2'10" x 8'0"<br>3'0" x 8'0" | <b>FCM6023</b><br>6<br>2'8" x 6'8"<br>2'10" x 6'8"<br>3'0" x 6'8" | <b>FCM6043</b><br>6<br>2'8" x 6'8"<br>2'10" x 6'8"<br>3'0" x 6'8" |
|---|---|---|---|--|---|--|---|---|

## Fiber-Classic® Oak



- |   |   |  |  |   |   |   |   |  |  |  |
|---|---|--|--|---|---|---|---|--|--|--|
| <b>FCM784</b><br>2'8" x 6'8"<br>2'10" x 6'8"<br>3'0" x 6'8" | <b>FCM787</b><br>2'8" x 6'8"<br>2'10" x 6'8"<br>3'0" x 6'8" | <b>FCM13101SL</b><br>6<br>10" x 6'8"<br>12" x 6'8" †‡<br>14" x 6'8" †‡ | <b>FCM81300SL</b><br>6<br>12" x 8'0"<br>14" x 8'0" | <b>FCM8113SL</b><br>6<br>12" x 8'0"<br>14" x 8'0" | <b>FCM8109SL</b><br>6<br>12" x 8'0"<br>14" x 8'0" | <b>FCM66SL</b><br>6<br>12" x 6'8"<br>14" x 6'8" | <b>FC11</b><br>6<br>2'6" x 6'8"<br>2'8" x 6'8" †<br>2'10" x 6'8" †<br>3'0" x 6'8" † | <b>81970P</b><br>6<br>2'8" x 8'0"<br>2'10" x 8'0"<br>3'0" x 8'0" | <b>FC669</b><br>6<br>2'6" x 6'8" †‡<br>2'8" x 6'8" †‡<br>2'10" x 6'8" †‡<br>3'0" x 6'8" †‡ | <b>FC813</b><br>6<br>2'6" x 8'0"<br>2'8" x 8'0"<br>2'10" x 8'0"<br>3'0" x 8'0" |
|---|---|--|--|---|---|---|---|--|--|--|



- |   |   |  |   |  |  |   |  |  |
|---|---|--|---|--|--|---|--|--|
| <b>FC763</b><br>6<br>2'8" x 6'8"<br>2'10" x 6'8"<br>3'0" x 6'8" | <b>FC768</b><br>6<br>2'8" x 6'8"<br>2'10" x 6'8"<br>3'0" x 6'8" | <b>81963P</b><br>6<br>2'8" x 8'0"<br>2'10" x 8'0"<br>3'0" x 8'0" | <b>FC66</b><br>6<br>2'6" x 6'8"<br>2'8" x 6'8" †<br>2'10" x 6'8" †<br>3'0" x 6'8" † | <b>81931P</b><br>6<br>2'8" x 8'0"<br>2'10" x 8'0"<br>3'0" x 8'0" | <b>81973P</b><br>6<br>2'8" x 8'0"<br>2'10" x 8'0"<br>3'0" x 8'0" | <b>FC44</b><br>2'8" x 6'8"<br>2'10" x 6'8"<br>3'0" x 6'8" | <b>FC784</b><br>2'8" x 6'8"<br>2'10" x 6'8"<br>3'0" x 6'8" | <b>FC787</b><br>2'8" x 6'8"<br>2'10" x 6'8"<br>3'0" x 6'8" |
|---|---|--|---|--|--|---|--|--|

Frosted Images Glass *Continues on next page.*

### Key

- No Stile Lines
- ◆ Black Nickel Caming (1D)
- Vented Sidelite (No Impact)  
(6'6" & 6'8" only in 12" & 14")  
(8'0" only in 14")
- ⬆ WBDR Options
- 6 WBDR / HVHZ Options
- † 6'6" Height Available
- ‡ 7'0" Height Available

## Frosted Images. Glass *Continued*

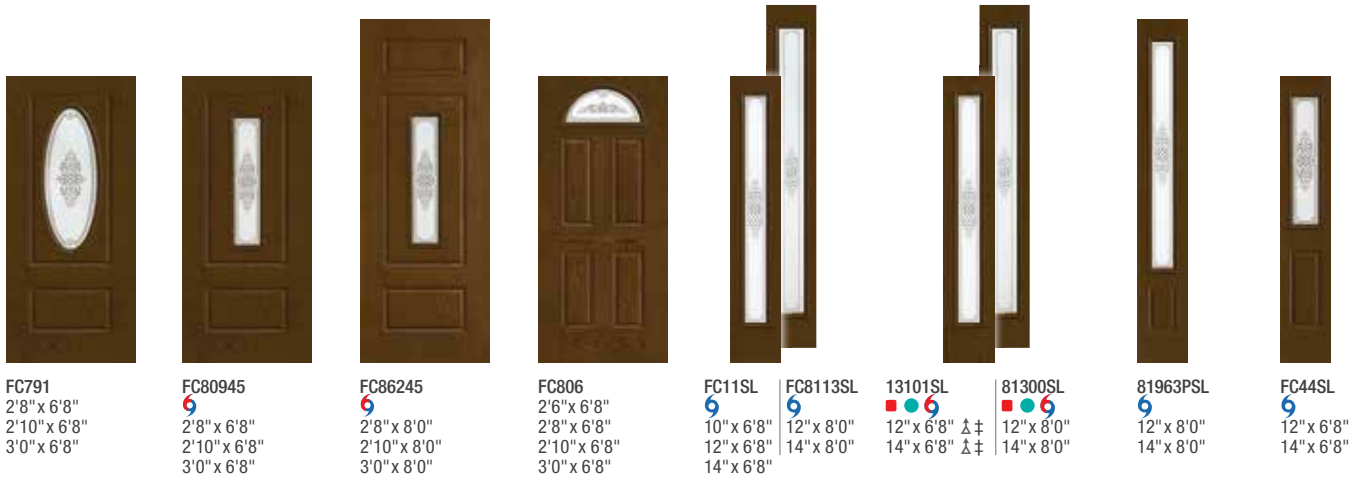

|  |  |  |   |   |   |  |  |   |   |
|--|--|--|---|---|---|--|--|---|---|
| <b>FC791</b><br>2'8" x 6'8"<br>2'10" x 6'8"<br>3'0" x 6'8" | <b>FC80945</b><br>2'8" x 6'8"<br>2'10" x 6'8"<br>3'0" x 6'8" | <b>FC86245</b><br>2'8" x 8'0"<br>2'10" x 8'0"<br>3'0" x 8'0" | <b>FC806</b><br>2'6" x 6'8"<br>2'8" x 6'8"<br>2'10" x 6'8"<br>3'0" x 6'8" | <b>FC11SL</b><br>10" x 6'8"<br>12" x 6'8"<br>14" x 6'8" | <b>FC8113SL</b><br>12" x 8'0"<br>14" x 8'0" | <b>13101SL</b><br>12" x 6'8" † ‡<br>14" x 6'8" † ‡ | <b>81300SL</b><br>12" x 8'0"<br>14" x 8'0" | <b>81963PSL</b><br>12" x 8'0"<br>14" x 8'0" | <b>FC44SL</b><br>12" x 6'8"<br>14" x 6'8" |
|--|--|--|---|---|---|--|--|---|---|

## Smooth-Star.



|  |  |   |  |  |  |   |  |  |  |
|--|--|---|--|--|--|---|--|--|--|
| <b>S138</b><br>2'6" x 6'8" †<br>2'8" x 6'8" † ‡<br>2'10" x 6'8" † ‡<br>3'0" x 6'8" † ‡ | <b>S812</b><br>2'6" x 8'0"<br>2'8" x 8'0"<br>2'10" x 8'0"<br>3'0" x 8'0" | <b>S669</b><br>2'6" x 6'8" †<br>2'8" x 6'8" † ‡<br>2'10" x 6'8" † ‡<br>3'0" x 6'8" † ‡<br>3'6" x 6'8" | <b>S813</b><br>2'6" x 8'0"<br>2'8" x 8'0"<br>2'10" x 8'0"<br>3'6" x 8'0" | <b>S84</b><br>2'8" x 6'8"<br>2'10" x 6'8"<br>3'0" x 6'8" | <b>S94</b><br>2'8" x 6'8"<br>2'10" x 6'8"<br>3'0" x 6'8" | <b>S884</b><br>2'8" x 8'0"<br>2'10" x 8'0"<br>3'0" x 8'0" | <b>S206E</b><br>2'8" x 6'8" † ‡<br>2'10" x 6'8" † ‡<br>3'0" x 6'8" † ‡ | <b>S81931P</b><br>2'8" x 8'0"<br>2'10" x 8'0"<br>3'0" x 8'0" | <b>S6023</b><br>2'8" x 6'8" † ‡<br>2'10" x 6'8" † ‡<br>3'0" x 6'8" † ‡ |
|--|--|---|--|--|--|---|--|--|--|



|  |  |   |   |  |   |   |  |   |
|--|--|---|---|--|---|---|--|---|
| <b>S6043</b><br>2'8" x 6'8"<br>2'10" x 6'8"<br>3'0" x 6'8" | <b>S34</b><br>2'8" x 6'8"<br>2'10" x 6'8"<br>3'0" x 6'8" | <b>S834</b><br>2'8" x 8'0"<br>2'10" x 8'0"<br>3'0" x 8'0" | <b>S250</b><br>2'8" x 6'8"<br>2'10" x 6'8"<br>3'0" x 6'8" | <b>S289E</b><br>2'8" x 6'8"<br>2'10" x 6'8"<br>3'0" x 6'8" | <b>S103</b><br>2'6" x 6'8" †<br>2'8" x 6'8" † ‡<br>2'10" x 6'8" † ‡<br>3'0" x 6'8" † ‡<br>3'6" x 6'8" | <b>S989</b><br>2'8" x 6'8"<br>2'10" x 6'8"<br>3'0" x 6'8" | <b>S6081</b><br>2'8" x 6'8"<br>2'10" x 6'8"<br>3'0" x 6'8" | <b>S994</b><br>2'8" x 6'8"<br>2'10" x 6'8"<br>3'0" x 6'8" |
|--|--|---|---|--|---|---|--|---|

### Privacy & Textured Glass Options

Add the code to the blank in the style number for the desired door and glass combination. For details on glass options, see page 119.

**XE = Satin Etch Glass**  
**XC = Chord Glass**

**XJ = Chinchilla Glass**  
**XR = Rainglass**

**XN = Granite Glass**

\*Not recommended for use behind storm doors or to be painted dark colors, if exposed to direct sunlight.  
Note: See page 273 for important product details that may help with your purchase decision.

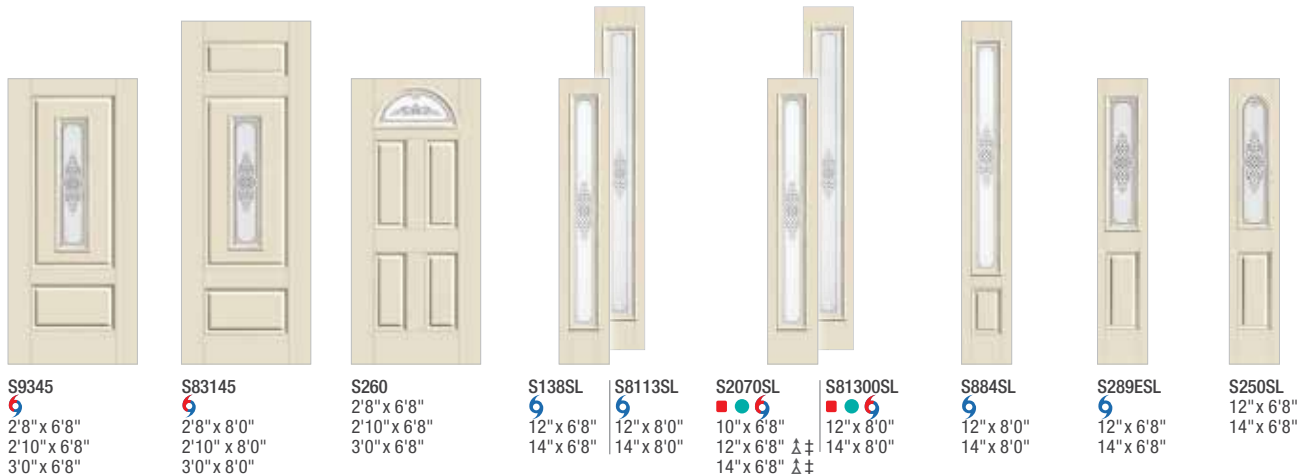

|   |  |   |  |   |   |  |  |   |   |
|---|--|---|--|---|---|--|--|---|---|
| <b>S9345</b><br>6<br>2'8" x 6'8"<br>2'10" x 6'8"<br>3'0" x 6'8" | <b>S83145</b><br>6<br>2'8" x 8'0"<br>2'10" x 8'0"<br>3'0" x 8'0" | <b>S260</b><br>2'8" x 6'8"<br>2'10" x 6'8"<br>3'0" x 6'8" | <b>S138SL</b><br>6<br>12" x 6'8"<br>14" x 6'8" | <b>S8113SL</b><br>6<br>12" x 8'0"<br>14" x 8'0" | <b>S2070SL</b><br>6<br>10" x 6'8"<br>12" x 6'8" ⚠<br>14" x 6'8" ⚠ | <b>S81300SL</b><br>6<br>12" x 8'0"<br>14" x 8'0" | <b>S884SL</b><br>6<br>12" x 8'0"<br>14" x 8'0" | <b>S289ESL</b><br>6<br>12" x 6'8"<br>14" x 6'8" | <b>S250SL</b><br>12" x 6'8"<br>14" x 6'8" |
|---|--|---|--|---|---|--|--|---|---|

# Flush-Glazed Privacy & Textured Glass with Divided Lites

Note: For details on divided lite options, see pages 120–121.

## Fiber-Classic® Oak

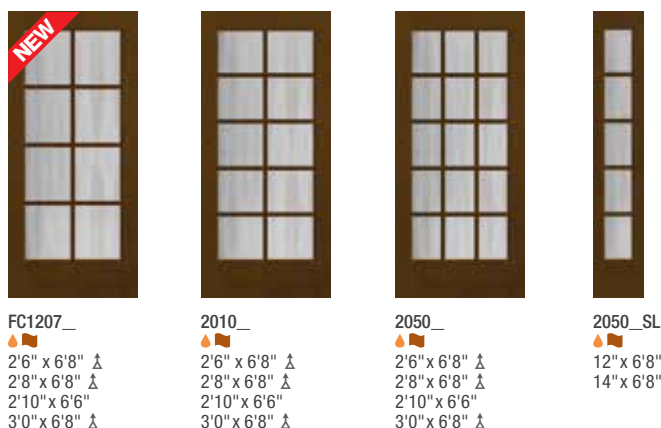

|  |  |  |   |
|--|--|--|---|
| <b>FC1207_</b><br>▲<br>2'6" x 6'8" ⚠<br>2'8" x 6'8" ⚠<br>2'10" x 6'6"<br>3'0" x 6'8" ⚠ | <b>2010_</b><br>▲<br>2'6" x 6'8" ⚠<br>2'8" x 6'8" ⚠<br>2'10" x 6'6"<br>3'0" x 6'8" ⚠ | <b>2050_</b><br>▲<br>2'6" x 6'8" ⚠<br>2'8" x 6'8" ⚠<br>2'10" x 6'6"<br>3'0" x 6'8" ⚠ | <b>2050_SL</b><br>▲<br>12" x 6'8"<br>14" x 6'8" |
|--|--|--|---|

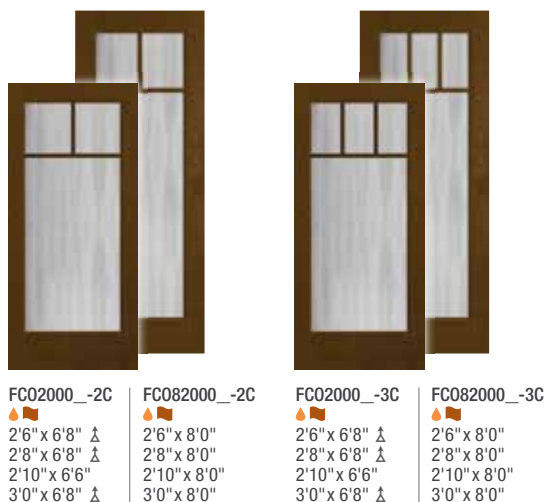

|  |   |  |   |
|--|---|--|---|
| <b>FC02000_-2C</b><br>▲<br>2'6" x 6'8" ⚠<br>2'8" x 6'8" ⚠<br>2'10" x 6'6"<br>3'0" x 6'8" ⚠ | <b>FC082000_-2C</b><br>▲<br>2'6" x 8'0"<br>2'8" x 8'0"<br>2'10" x 8'0"<br>3'0" x 8'0" | <b>FC02000_-3C</b><br>▲<br>2'6" x 6'8" ⚠<br>2'8" x 6'8" ⚠<br>2'10" x 6'6"<br>3'0" x 6'8" ⚠ | <b>FC082000_-3C</b><br>▲<br>2'6" x 8'0"<br>2'8" x 8'0"<br>2'10" x 8'0"<br>3'0" x 8'0" |
|--|---|--|---|



Flush-Glazed Privacy & Textured Glass with Divided Lites *Continues on next page.*

### Key

- No Stile Lines
- ▲ Flush-Glazed Glass (FG)
- Simulated Divided Lites (SDL)\*
- Vented Sidelite (No Impact)  
(6'6" & 6'8" only in 12" & 14")  
(8'0" only in 14")
- ⚠ 6'6" Height Available
- ⚠ 7'0" Height Available
- Ⓜ WBDR Options
- Ⓜ WBDR / HVHZ Options



## Flush-Glazed Privacy & Textured Glass with Divided Lites *Continued*



**FC02000\_-4C**  
 ▲ ▲  
 2'6" x 6'8" ▲  
 2'8" x 6'8" ▲  
 2'10" x 6'6" ▲  
 3'0" x 6'8" ▲



**FC082000\_-4C**  
 ▲ ▲  
 2'6" x 8'0" ▲  
 2'8" x 8'0" ▲  
 2'10" x 8'0" ▲  
 3'0" x 8'0" ▲



**FC02000\_-6C**  
 ▲ ▲  
 2'6" x 6'8" ▲  
 2'8" x 6'8" ▲  
 2'10" x 6'6" ▲  
 3'0" x 6'8" ▲

**FC082000\_-6C**  
 ▲ ▲  
 2'6" x 8'0" ▲  
 2'8" x 8'0" ▲  
 2'10" x 8'0" ▲  
 3'0" x 8'0" ▲



**FC5700\_**  
 ▲ ▲  
 2'6" x 6'8" ▲  
 2'8" x 6'8" ▲  
 2'10" x 6'6" ▲  
 3'0" x 6'8" ▲

**FC85700\_**  
 ▲ ▲  
 2'6" x 8'0" ▲  
 2'8" x 8'0" ▲  
 2'10" x 8'0" ▲  
 3'0" x 8'0" ▲

**FC5710\_**  
 ▲ ▲  
 2'6" x 6'8" ▲  
 2'8" x 6'8" ▲  
 2'10" x 6'6" ▲  
 3'0" x 6'8" ▲

**FC85710\_**  
 ▲ ▲  
 2'6" x 8'0" ▲  
 2'8" x 8'0" ▲  
 2'10" x 8'0" ▲  
 3'0" x 8'0" ▲



**FC5720\_**  
 ▲ ▲  
 2'6" x 6'8" ▲  
 2'8" x 6'8" ▲  
 2'10" x 6'6" ▲  
 3'0" x 6'8" ▲

**FC85720\_**  
 ▲ ▲  
 2'6" x 8'0" ▲  
 2'8" x 8'0" ▲  
 2'10" x 8'0" ▲  
 3'0" x 8'0" ▲



**FC5700\_SL**  
 ▲ ▲  
 12" x 6'8" ▲  
 14" x 6'8" ▲



**FC5710\_SL**  
 ▲ ▲  
 12" x 6'8" ▲  
 14" x 6'8" ▲



**FC5720\_SL**  
 ▲ ▲  
 12" x 6'8" ▲  
 14" x 6'8" ▲

## Smooth-Star®



**S1207\_**  
 ▲ ▲  
 2'6" x 6'8" ▲  
 2'8" x 6'8" ▲  
 2'10" x 6'8" ▲  
 3'0" x 6'8" ▲



**S82105\_**  
 ▲ ▲  
 2'6" x 8'0" ▲  
 2'8" x 8'0" ▲  
 2'10" x 8'0" ▲  
 3'0" x 8'0" ▲



**S82106\_**  
 ▲ ▲  
 2'6" x 8'0" ▲  
 2'8" x 8'0" ▲  
 2'10" x 8'0" ▲  
 3'0" x 8'0" ▲



**S82107\_**  
 ▲ ▲  
 2'6" x 8'0" ▲  
 2'8" x 8'0" ▲  
 2'10" x 8'0" ▲  
 3'0" x 8'0" ▲



**S2010\_SL**  
 ▲ ▲  
 10" x 6'8" ▲  
 12" x 6'8" ▲  
 14" x 6'8" ▲

**S84886\_SL**  
 ▲ ▲  
 12" x 8'0" ▲  
 14" x 8'0" ▲



**S2000\_-2C**  
 ▲ ▲  
 2'6" x 6'8" ▲  
 2'8" x 6'8" ▲  
 2'10" x 6'8" ▲  
 3'0" x 6'8" ▲

**S82000\_-2C**  
 ▲ ▲  
 2'6" x 8'0" ▲  
 2'8" x 8'0" ▲  
 2'10" x 8'0" ▲  
 3'0" x 8'0" ▲



**S2000\_-3C**  
 ▲ ▲  
 2'6" x 6'8" ▲  
 2'8" x 6'8" ▲  
 2'10" x 6'8" ▲  
 3'0" x 6'8" ▲

**S82000\_-3C**  
 ▲ ▲  
 2'6" x 8'0" ▲  
 2'8" x 8'0" ▲  
 2'10" x 8'0" ▲  
 3'0" x 8'0" ▲



**S2000\_-4C**  
 ▲ ▲  
 2'6" x 6'8" ▲  
 2'8" x 6'8" ▲  
 2'10" x 6'8" ▲  
 3'0" x 6'8" ▲

**S82000\_-4C**  
 ▲ ▲  
 2'6" x 8'0" ▲  
 2'8" x 8'0" ▲  
 2'10" x 8'0" ▲  
 3'0" x 8'0" ▲

### Privacy & Textured Glass Options

Add the code to the blank in the style number for the desired door and glass combination. For details on glass options, see page 119.

**XE = Satin Etch Glass**  
**XC = Chord Glass**

**XJ = Chinchilla Glass**  
**XR = Rainglass**

**XN = Granite Glass**

\*Not recommended for use behind storm doors or to be painted dark colors, if exposed to direct sunlight.  
 Note: See page 273 for important product details that may help with your purchase decision.



**S2000\_-6C**  
 ▲ Simulated Divided Lites (SDL)  
 2'6" x 6'8" ▲  
 2'8" x 6'8" ▲  
 2'10" x 6'8" ▲  
 3'0" x 6'8" ▲

**S82000\_-6C**  
 ▲ Simulated Divided Lites (SDL)  
 2'6" x 8'0"  
 2'8" x 8'0"  
 2'10" x 8'0"  
 3'0" x 8'0"



**S82112\_**  
 ▲ Simulated Divided Lites (SDL)  
 2'6" x 8'0"  
 2'8" x 8'0"  
 2'10" x 8'0"  
 3'0" x 8'0"



**S82113\_**  
 ▲ Simulated Divided Lites (SDL)  
 2'6" x 8'0"  
 2'8" x 8'0"  
 2'10" x 8'0"  
 3'0" x 8'0"



**S82114\_**  
 ▲ Simulated Divided Lites (SDL)  
 2'6" x 8'0"  
 2'8" x 8'0"  
 2'10" x 8'0"  
 3'0" x 8'0"



**S82116\_**  
 ▲ Simulated Divided Lites (SDL)  
 2'6" x 8'0"  
 2'8" x 8'0"  
 2'10" x 8'0"  
 3'0" x 8'0"



**S4812\_**  
 ▲ Simulated Divided Lites (SDL)  
 2'8" x 6'8"  
 2'10" x 6'8"  
 3'0" x 6'8"

**S84812\_**  
 ▲ Simulated Divided Lites (SDL)  
 2'8" x 8'0"  
 2'10" x 8'0"  
 3'0" x 8'0"



**S4813\_**  
 ▲ Simulated Divided Lites (SDL)  
 2'8" x 6'8"  
 2'10" x 6'8"  
 3'0" x 6'8"

**S84813\_**  
 ▲ Simulated Divided Lites (SDL)  
 2'8" x 8'0"  
 2'10" x 8'0"  
 3'0" x 8'0"



**S4814\_**  
 ▲ Simulated Divided Lites (SDL)  
 2'8" x 6'8"  
 2'10" x 6'8"  
 3'0" x 6'8"

**S84814\_**  
 ▲ Simulated Divided Lites (SDL)  
 2'8" x 8'0"  
 2'10" x 8'0"  
 3'0" x 8'0"



**S4816\_**  
 ▲ Simulated Divided Lites (SDL)  
 2'8" x 6'8"  
 2'10" x 6'8"  
 3'0" x 6'8"

**S84816\_**  
 ▲ Simulated Divided Lites (SDL)  
 2'8" x 8'0"  
 2'10" x 8'0"  
 3'0" x 8'0"



**S2000\_SL-2C**  
 ▲ Simulated Divided Lites (SDL)  
 10" x 6'8" ▲  
 12" x 6'8" ▲  
 14" x 6'8" ▲



**S2000\_SL-4C**  
 ▲ Simulated Divided Lites (SDL)  
 10" x 6'8" ▲  
 12" x 6'8" ▲  
 14" x 6'8" ▲



**S4812\_SL**  
 ▲ Simulated Divided Lites (SDL)  
 12" x 6'8"  
 14" x 6'8"

**S84812\_SL**  
 ▲ Simulated Divided Lites (SDL)  
 12" x 8'0"  
 14" x 8'0"



**S5700\_**  
 ▲ Simulated Divided Lites (SDL)  
 2'6" x 6'8" ▲  
 2'8" x 6'8" ▲  
 2'10" x 6'8" ▲  
 3'0" x 6'8" ▲

**S85700\_**  
 ▲ Simulated Divided Lites (SDL)  
 2'6" x 8'0"  
 2'8" x 8'0"  
 2'10" x 8'0"  
 3'0" x 8'0"



**S5710\_**  
 ▲ Simulated Divided Lites (SDL)  
 2'6" x 6'8" ▲  
 2'8" x 6'8" ▲  
 2'10" x 6'8" ▲  
 3'0" x 6'8" ▲

**S85710\_**  
 ▲ Simulated Divided Lites (SDL)  
 2'6" x 8'0"  
 2'8" x 8'0"  
 2'10" x 8'0"  
 3'0" x 8'0"



**S5720\_**  
 ▲ Simulated Divided Lites (SDL)  
 2'6" x 6'8" ▲  
 2'8" x 6'8" ▲  
 2'10" x 6'8" ▲  
 3'0" x 6'8" ▲

**S85720\_**  
 ▲ Simulated Divided Lites (SDL)  
 2'6" x 8'0"  
 2'8" x 8'0"  
 2'10" x 8'0"  
 3'0" x 8'0"



**S85730\_**  
 ▲ Simulated Divided Lites (SDL)  
 2'6" x 8'0"  
 2'8" x 8'0"  
 2'10" x 8'0"  
 3'0" x 8'0"

**Flush-Glazed Privacy & Textured Glass with Divided Lites** *Continues on next page.*

**Key**

- ▲ Flush-Glazed Glass (FG)
- ▲ Simulated Divided Lites (SDL)\*
- ▲ Simulated Divided Lites (SDLF1)\*

- ▲ Simulated Divided Lites (SDLF2)\*
- Vented Sidelite (No Impact)  
(6'6" & 6'8" only in 12" & 14")  
(8'0" only in 14")

- ▲ 6'6" Height Available
- ± 7'0" Height Available

**Optional Dentil Shelf\***

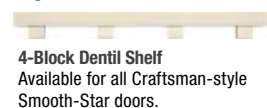

## Flush-Glazed Privacy & Textured Glass with Divided Lites *Continued*



S5700\_SL S85700\_SL  
 ▲ R  
 10" x 6'8" 12" x 8'0"  
 12" x 6'8" 14" x 8'0"  
 14" x 6'8"



S5710\_SL S85710\_SL  
 ▲ R  
 10" x 6'8" 12" x 8'0"  
 12" x 6'8" 14" x 8'0"  
 14" x 6'8"



S5720\_SL S85720\_SL  
 ▲ R  
 10" x 6'8" 12" x 8'0"  
 12" x 6'8" 14" x 8'0"  
 14" x 6'8"

# Flush-Glazed Privacy & Textured Glass

## Fiber-Classic® Oak

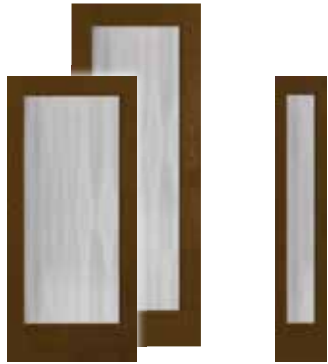

2000\_ 8000\_  
 ▲ 2'0" x 6'8" ▲ 2'0" x 8'0"  
 2'6" x 6'8" ▲ 2'6" x 8'0"  
 2'8" x 6'8" ▲ 2'8" x 8'0"  
 2'10" x 6'6" ▲ 2'10" x 8'0"  
 3'0" x 6'8" ▲ 3'0" x 8'0"

2000\_SL  
 ▲ 12" x 6'8"  
 14" x 6'8"

## Smooth-Star®



S2000\_ S8000\_  
 ▲ 2'0" x 6'8" ▲ 2'0" x 8'0"  
 2'6" x 6'8" ▲ 2'6" x 8'0"  
 2'8" x 6'8" ▲ 2'8" x 8'0"  
 2'10" x 6'8" ▲ 2'10" x 8'0"  
 3'0" x 6'8" ▲ 3'0" x 8'0"

S82200\_  
 ▲ 2'6" x 8'0"  
 2'8" x 8'0"  
 2'10" x 8'0"  
 3'0" x 8'0"

S4810\_ S84810\_  
 ▲ 2'8" x 6'8" ▲ 2'8" x 8'0"  
 2'10" x 6'8" ▲ 2'10" x 8'0"  
 3'0" x 6'8" ▲ 3'0" x 8'0"



S2000\_SL S8000\_SL  
 ▲ 10" x 6'8" ▲ 12" x 8'0"  
 12" x 6'8" ▲ 14" x 8'0"  
 14" x 6'8" ▲



S4810\_SL S84810\_SL  
 ▲ 12" x 6'8" ▲ 12" x 8'0"  
 14" x 6'8" ▲ 14" x 8'0"

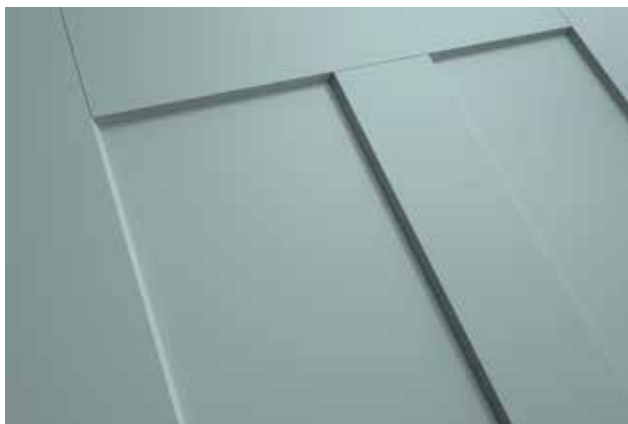

### Privacy & Textured Glass Options

Add the code to the blank in the style number for the desired door and glass combination. For details on glass options, see page 119.

XE = Satin Etch Glass  
 XC = Chord Glass

XJ = Chinchilla Glass  
 XR = Rainglass

XN = Granite Glass

\*Not recommended for use behind storm doors or to be painted dark colors, if exposed to direct sunlight.  
 Note: See page 273 for important product details that may help with your purchase decision.



# Privacy & Textured Glass with Divided Lites

## Fiber-Classic® Mahogany

Note: For details on divided lite options, see pages 120–121.



**FCM138\_**  
 2'8" x 6'8"  
 2'10" x 6'8"  
 3'0" x 6'8"



**FCM1285\_**  
 2'6" x 6'8" Δ‡  
 2'8" x 6'8" Δ‡  
 2'10" x 6'8" Δ‡  
 3'0" x 6'8" Δ‡



**FCM18\_**  
 2'8" x 6'8"  
 2'10" x 6'8"  
 3'0" x 6'8"



**FCM1284\_**  
 2'6" x 6'8" Δ‡  
 2'8" x 6'8" Δ‡  
 2'10" x 6'8" Δ‡  
 3'0" x 6'8" Δ‡



**FCM82\_**  
 2'8" x 6'8"  
 2'10" x 6'8"  
 3'0" x 6'8"



**FCM65\_**  
 2'8" x 6'8"  
 2'10" x 6'8"  
 3'0" x 6'8"



**FCM6022\_**  
 2'8" x 6'8"  
 2'10" x 6'8"  
 3'0" x 6'8"



**FCM6042\_**  
 2'8" x 6'8"  
 2'10" x 6'8"  
 3'0" x 6'8"



**FCM8321\_**  
 2'8" x 8'0"  
 2'10" x 8'0"  
 3'0" x 8'0"



**FCM12102\_SL**  
 12" x 6'8" Δ‡  
 14" x 6'8" Δ‡



**FCM92\_SL**  
 12" x 6'8"  
 14" x 6'8"



**FCM8101\_SL**  
 12" x 8'0"  
 14" x 8'0"



**FCM65\_SL**  
 12" x 6'8"  
 14" x 6'8"



**FCM3487\_SL**  
 12" x 8'0"  
 14" x 8'0"



**FCM605\_**  
 2'8" x 6'8"  
 2'10" x 6'8"  
 3'0" x 6'8"

## Fiber-Classic® Oak



**FCM606\_**  
 2'8" x 6'8"  
 2'10" x 6'8"  
 3'0" x 6'8"



**FCM607\_**  
 2'8" x 6'8"  
 2'10" x 6'8"  
 3'0" x 6'8"



**FCM608\_**  
 2'8" x 6'8"  
 2'10" x 6'8"  
 3'0" x 6'8"



**FCM6124\_SL**  
 12" x 6'8"  
 14" x 6'8"



**FCM6125\_SL**  
 12" x 6'8"  
 14" x 6'8"



**FCM6126\_SL**  
 12" x 6'8"  
 14" x 6'8"



**FC138\_**  
 2'6" x 6'8"  
 2'8" x 6'8" ‡  
 2'10" x 6'8" ‡  
 3'0" x 6'8" ‡



**1285\_**  
 2'6" x 6'8" Δ‡  
 2'8" x 6'8" Δ‡  
 2'10" x 6'8" Δ‡  
 3'0" x 6'8" Δ‡

Privacy & Textured Glass with Divided Lites *Continues on next page.*

### Key

- No Stile Lines
- Flush-Glazed Glass (FG)
- Simulated Divided Lites (SDL)\*
- Simulated Divided Lites (SDLF2)\*
- Vented Sidelite (No Impact)  
(6'6" & 6'8" only in 12" & 14"  
8'0" only in 14")
- ▲ 6'6" Height Available
- ‡ 7'0" Height Available

### Optional Dentil Shelves\*

- 

**4-Block Dentil Shelf**  
 Available for all Craftsman-style  
 Fiber-Classic Mahogany Collection doors.



**4-Block Dentil Shelf**  
 Available for all Craftsman-style  
 Smooth-Star doors.

## Privacy & Textured Glass with Divided Lites *Continued*



FC18\_

2'6" x 6'8"  
2'8" x 6'8" ‡  
2'10" x 6'8" ‡  
3'0" x 6'8" ‡



1284\_

2'6" x 6'8" Δ ‡  
2'8" x 6'8" Δ ‡  
2'10" x 6'8" Δ ‡  
3'0" x 6'8" Δ ‡



FC82\_

2'8" x 6'8"  
2'10" x 6'8"  
3'0" x 6'8"



FC92\_

2'8" x 6'8"  
2'10" x 6'8"  
3'0" x 6'8"



81945P\_

2'8" x 8'0"  
2'10" x 8'0"  
3'0" x 8'0"



81946P\_

2'8" x 8'0"  
2'10" x 8'0"  
3'0" x 8'0"



FC65\_

2'6" x 6'8"  
2'8" x 6'8" ‡  
2'10" x 6'8" ‡  
3'0" x 6'8" ‡



FC8321\_

2'8" x 8'0"  
2'10" x 8'0"  
3'0" x 8'0"



FC832\_

2'8" x 8'0"  
2'10" x 8'0"  
3'0" x 8'0"



FC807\_

2'8" x 6'8"  
2'10" x 6'8"  
3'0" x 6'8"



FC809203\_

2'8" x 6'8"  
2'10" x 6'8"  
3'0" x 6'8"



FC862203\_

2'8" x 8'0"  
2'10" x 8'0"  
3'0" x 8'0"



FC18\_SL

12" x 6'8"  
14" x 6'8"



12102\_SL

12" x 6'8" Δ ‡  
14" x 6'8" Δ ‡



FC92\_SL

12" x 6'8"  
14" x 6'8"



81946P\_SL

12" x 8'0"  
14" x 8'0"



FC63\_SL

12" x 6'8"  
14" x 6'8"



FC3487\_SL

12" x 8'0"  
14" x 8'0"



FC06188\_SL

10" x 6'8"  
12" x 6'8"  
14" x 6'8"



FC06184\_SL

12" x 6'8" Δ ‡  
14" x 6'8" Δ ‡



FC06189\_SL

10" x 6'8"  
12" x 6'8"  
14" x 6'8"



FC06185\_SL

12" x 6'8" Δ ‡  
14" x 6'8" Δ ‡



FC06190\_SL

10" x 6'8"  
12" x 6'8"  
14" x 6'8"



FC06186\_SL

12" x 6'8" Δ ‡  
14" x 6'8" Δ ‡

### Privacy & Textured Glass Options

Add the code to the blank in the style number for the desired door and glass combination. For details on glass options, see page 119.

**XE** = Satin Etch Glass  
**XC** = Chord Glass

**XJ** = Chinchilla Glass  
**XR** = Rainglass

**XN** = Granite Glass

\*Not recommended for use behind storm doors or to be painted dark colors, if exposed to direct sunlight.  
Note: See page 273 for important product details that may help with your purchase decision.

# Smooth-Star®



**S128\_**  
 ■ ■  
 2'6" x 6'8" ▲  
 2'8" x 6'8" ▲ ‡  
 2'10" x 6'8" ▲ ‡  
 3'0" x 6'8" ▲ ‡



**S141\_**  
 ■ ■  
 2'6" x 6'8" ▲  
 2'8" x 6'8" ▲ ‡  
 2'10" x 6'8" ▲ ‡  
 3'0" x 6'8" ▲ ‡  
 3'6" x 6'8"



**S108\_**  
 ■ ■  
 2'6" x 6'8" ▲  
 2'8" x 6'8" ▲ ‡  
 2'10" x 6'8" ▲ ‡  
 3'0" x 6'8" ▲ ‡



**S6063\_**  
 ■ ■  
 2'6" x 6'8" ▲  
 2'8" x 6'8" ▲ ‡  
 2'10" x 6'8" ▲ ‡  
 3'0" x 6'8" ▲ ‡  
 3'6" x 6'8"



**S82\_**  
 ■ ■  
 2'8" x 6'8"  
 2'10" x 6'8"  
 3'0" x 6'8"



**S92\_**  
 ■ ■  
 2'8" x 6'8"  
 2'10" x 6'8"  
 3'0" x 6'8"



**S881\_**  
 ■ ■  
 2'8" x 8'0"  
 2'10" x 8'0"  
 3'0" x 8'0"



**S822\_**  
 ■ ■  
 2'8" x 8'0"  
 2'10" x 8'0"  
 3'0" x 8'0"



**S262\_**  
 ■ ■  
 2'8" x 6'8" ‡  
 2'10" x 6'8" ‡  
 3'0" x 6'8" ‡



**S6022\_**  
 ■ ■  
 2'8" x 6'8" ‡  
 2'10" x 6'8" ‡  
 3'0" x 6'8" ‡



**S6042\_**  
 ■ ■  
 2'8" x 6'8"  
 2'10" x 6'8"  
 3'0" x 6'8"



**S32\_**  
 ■ ■  
 2'8" x 6'8"  
 2'10" x 6'8"  
 3'0" x 6'8"



**S8321\_**  
 ■ ■  
 2'8" x 8'0"  
 2'10" x 8'0"  
 3'0" x 8'0"



**S832\_**  
 ■ ■  
 2'8" x 8'0"  
 2'10" x 8'0"  
 3'0" x 8'0"



**S807\_**  
 ■ ■  
 2'8" x 6'8"  
 2'10" x 6'8"  
 3'0" x 6'8"



**S93203\_**  
 ■ ■  
 2'8" x 6'8"  
 2'10" x 6'8"  
 3'0" x 6'8"



**S831203\_**  
 ■ ■  
 2'8" x 8'0"  
 2'10" x 8'0"  
 3'0" x 8'0"



**S308\_SL**  
 ■ ■  
 12" x 6'8"  
 14" x 6'8"



**S1170\_SL**  
 ■ ■ ●  
 10" x 6'8"  
 12" x 6'8" ▲ ‡  
 14" x 6'8" ▲ ‡



**S82\_SL**  
 ■ ■  
 12" x 6'8"  
 14" x 6'8"



**S881\_SL**  
 ■ ■  
 12" x 8'0"  
 14" x 8'0"



**S263\_SL**  
 ■ ■  
 12" x 6'8"  
 14" x 6'8"



**S3487\_SL**  
 ■ ■  
 12" x 8'0"  
 14" x 8'0"

**Privacy & Textured Glass with Divided Lites** *Continues on next page.*

## Key

■ No Stile Lines  
 ■ Simulated Divided Lites (SDL)\*

● Vented Sidelite (No Impact)  
 (6'6" & 6'8" only in 12" & 14")  
 (8'0" only in 14")

▲ 6'6" Height Available  
 ‡ 7'0" Height Available



## Privacy & Textured Glass *Continued*



**S605\_**  
 2'8" x 6'8"  
 2'10" x 6'8"  
 3'0" x 6'8"



**S8605\_**  
 2'8" x 8'0"  
 2'10" x 8'0"  
 3'0" x 8'0"



**S606\_**  
 2'8" x 6'8"  
 2'10" x 6'8"  
 3'0" x 6'8"



**S8606\_**  
 2'8" x 8'0"  
 2'10" x 8'0"  
 3'0" x 8'0"



**S607\_**  
 2'8" x 6'8"  
 2'10" x 6'8"  
 3'0" x 6'8"



**S8607\_**  
 2'8" x 8'0"  
 2'10" x 8'0"  
 3'0" x 8'0"



**S608\_**  
 2'8" x 6'8"  
 2'10" x 6'8"  
 3'0" x 6'8"



**S8608\_**  
 2'8" x 8'0"  
 2'10" x 8'0"  
 3'0" x 8'0"



**S605\_SL**  
 12" x 6'8"  
 14" x 6'8"



**S6124\_SL**  
 10" x 6'8"  
 12" x 6'8" Δ ‡  
 14" x 6'8" Δ ‡



**S606\_SL**  
 12" x 6'8"  
 14" x 6'8"



**S6125\_SL**  
 10" x 6'8"  
 12" x 6'8" Δ ‡  
 14" x 6'8" Δ ‡



**S607\_SL**  
 12" x 6'8"  
 14" x 6'8"



**S6126\_SL**  
 10" x 6'8"  
 12" x 6'8" Δ ‡  
 14" x 6'8" Δ ‡

## Privacy & Textured Glass

### Fiber-Classic® Mahogany

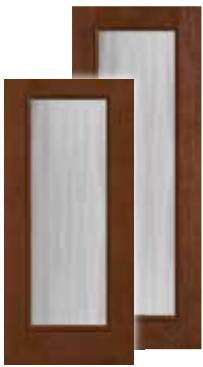

**FCM10\_**  
 2'8" x 6'8"  
 2'10" x 6'8"  
 3'0" x 6'8"



**FCM870\_**  
 2'8" x 8'0"  
 2'10" x 8'0"  
 3'0" x 8'0"



**FCM1283\_**  
 2'4" x 6'8" Δ  
 2'6" x 6'8" Δ ‡  
 2'8" x 6'8" Δ ‡  
 2'10" x 6'8" Δ ‡  
 3'0" x 6'8" Δ ‡



**FCM81200\_**  
 2'6" x 8'0"  
 2'8" x 8'0"  
 2'10" x 8'0"  
 3'0" x 8'0"



**FCM32\_**  
 2'8" x 6'8"  
 2'10" x 6'8"  
 3'0" x 6'8"



**FCM62\_**  
 2'8" x 6'8"  
 2'10" x 6'8"  
 3'0" x 6'8"



**FCM862\_**  
 2'8" x 8'0"  
 2'10" x 8'0"  
 3'0" x 8'0"



**FCM6021\_**  
 2'8" x 6'8"  
 2'10" x 6'8"  
 3'0" x 6'8"

### Privacy & Textured Glass Options

Add the code to the blank in the style number for the desired door and glass combination. For details on glass options, see page 119.

**XE** = Satin Etch Glass  
**XC** = Chord Glass

**XJ** = Chinchilla Glass  
**XR** = Rainglass

**XN** = Granite Glass

\*Not recommended for use behind storm doors or to be painted dark colors, if exposed to direct sunlight.  
 Note: See page 273 for important product details that may help with your purchase decision.



FCM6041\_  
6  
2'8" x 6'8"  
2'10" x 6'8"  
3'0" x 6'8"



FCM104\_  
6  
2'8" x 6'8" ‡  
2'10" x 7'0"  
3'0" x 6'8" ‡



FCM601\_  
6  
2'8" x 6'8"  
2'10" x 6'8"  
3'0" x 6'8"



FCM708\_  
2'8" x 6'8"  
2'10" x 6'8"  
3'0" x 6'8"  
FCM8708\_  
2'8" x 8'0"  
2'10" x 8'0"  
3'0" x 8'0"



FCM61\_  
2'8" x 6'8"  
2'10" x 6'8"  
3'0" x 6'8"  
FCM861\_  
2'8" x 8'0"  
2'10" x 8'0"  
3'0" x 8'0"



FCM12101\_SL  
6  
10" x 6'8"  
12" x 6'8" † ‡  
14" x 6'8" † ‡



FCM81200\_SL  
6  
12" x 8'0"  
14" x 8'0"



FCM870\_SL  
6  
12" x 8'0"  
14" x 8'0"

FCM32\_SL  
6  
12" x 6'8"  
14" x 6'8"

FCM881\_SL  
6  
12" x 8'0"  
14" x 8'0"



FCM62\_SL  
6  
12" x 6'8"  
14" x 6'8"



FCM862\_SL  
6  
12" x 8'0"  
14" x 8'0"

## Fiber-Classic® Oak



1283\_  
6  
2'4" x 6'8" †  
2'6" x 6'8" † ‡  
2'8" x 6'8" † ‡  
2'10" x 6'8" † ‡  
3'0" x 6'8" † ‡  
81200\_  
6  
2'6" x 8'0"  
2'8" x 8'0"  
2'10" x 8'0"  
3'0" x 8'0"

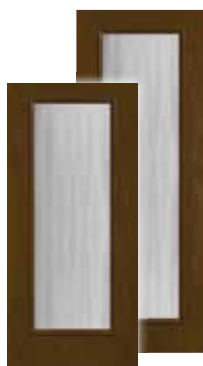

FC10\_  
6  
2'6" x 6'8"  
2'8" x 6'8" ‡  
2'10" x 6'8" ‡  
3'0" x 6'8" ‡  
81200P\_  
6  
2'8" x 8'0"  
2'10" x 8'0"  
3'0" x 8'0"



FC766\_  
6  
2'8" x 6'8"  
2'10" x 6'8"  
3'0" x 6'8"  
81943P\_  
6  
2'8" x 8'0"  
2'10" x 8'0"  
3'0" x 8'0"



FC32\_  
6  
2'8" x 6'8"  
2'10" x 6'8"  
3'0" x 6'8"



FC62\_  
6  
2'6" x 6'8"  
2'8" x 6'8" ‡  
2'10" x 6'8" ‡  
3'0" x 6'8" ‡  
81929P\_  
6  
2'8" x 8'0"  
2'10" x 8'0"  
3'0" x 8'0"

Privacy & Textured Glass *Continues on next page.*

### Key

- No Stile Lines
- Simulated Divided Lites (SDL)\*
- Vented Sidelite (No Impact)  
(6'6" & 6'8" only in 12" & 14")  
(8'0" only in 14")

- 6 WBDR Options
- 6 WBDR / HVHZ Options
- † 6'6" Height Available
- ‡ 7'0" Height Available

### Optional Dentil Shelves\*



4-Block Dentil Shelf  
Available for all Craftsman-style  
Fiber-Classic Mahogany Collection doors.



4-Block Dentil Shelf  
Available for all Craftsman-style  
Smooth-Star doors.

## Privacy & Textured Glass *Continued*



**FC104\_**  
 ■ 6  
 2'8" x 6'8" ‡  
 2'10" x 6'8" ‡  
 3'0" x 6'8" ‡

**81971P\_**  
 6  
 2'8" x 8'0"  
 2'10" x 8'0"  
 3'0" x 8'0"

**FC48\_**  
 2'8" x 6'8"  
 2'10" x 6'8"  
 3'0" x 6'8"

**FC80920\_**  
 6  
 2'8" x 6'8"  
 2'10" x 6'8"  
 3'0" x 6'8"

**FC86220\_**  
 6  
 2'8" x 8'0"  
 2'10" x 8'0"  
 3'0" x 8'0"

**FC708\_**  
 2'8" x 6'8" ‡  
 2'10" x 6'8" ‡  
 3'0" x 6'8" ‡

**FC8708\_**  
 2'8" x 8'0"  
 2'10" x 8'0"  
 3'0" x 8'0"

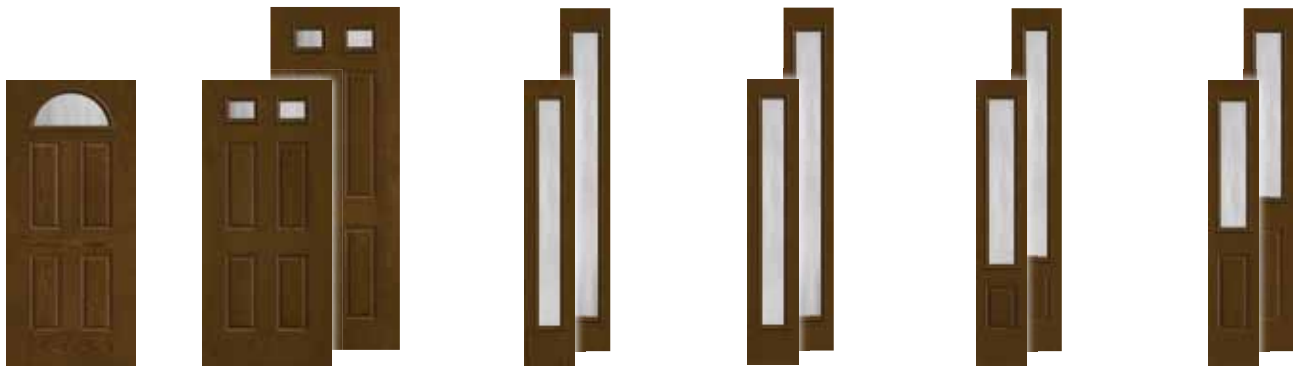

**FC803\_**  
 2'6" x 6'8"  
 2'8" x 6'8"  
 2'10" x 6'8"  
 3'0" x 6'8"

**FC61\_**  
 2'6" x 6'8" ‡  
 2'8" x 6'8" ‡  
 2'10" x 6'8" ‡  
 3'0" x 6'8" ‡

**FC861\_**  
 2'8" x 8'0"  
 2'10" x 8'0"  
 3'0" x 8'0"

**12101\_SL**  
 ■ 6  
 12" x 6'8" ‡ ‡  
 14" x 6'8" ‡ ‡

**81200\_SL**  
 ■ 6  
 12" x 8'0"  
 14" x 8'0"

**FC47\_SL**  
 6  
 10" x 6'8"  
 12" x 6'8"  
 14" x 6'8"

**81200P\_SL**  
 6  
 12" x 8'0"  
 14" x 8'0"

**FC32\_SL**  
 6  
 12" x 6'8"  
 14" x 6'8"

**81943P\_SL**  
 6  
 12" x 8'0"  
 14" x 8'0"

**FC48\_SL**  
 6  
 12" x 6'8"  
 14" x 6'8"

**81929P\_SL**  
 6  
 12" x 8'0"  
 14" x 8'0"

## Smooth-Star®



**S140\_**  
 ■ 6  
 2'4" x 6'8" ‡  
 2'6" x 6'8" ‡  
 2'8" x 6'8" ‡ ‡  
 2'10" x 6'8" ‡ ‡  
 3'0" x 6'8" ‡ ‡  
 3'6" x 6'8"

**S8140\_**  
 ■ 6  
 2'6" x 8'0"  
 2'8" x 8'0"  
 2'10" x 8'0"  
 3'0" x 8'0"  
 3'6" x 8'0"

**S118\_**  
 6  
 2'6" x 6'8" ‡  
 2'8" x 6'8" ‡ ‡  
 2'10" x 6'8" ‡ ‡  
 3'0" x 6'8" ‡ ‡

**S818\_**  
 6  
 2'6" x 8'0"  
 2'8" x 8'0"  
 2'10" x 8'0"  
 3'0" x 8'0"

**S90\_**  
 6  
 2'8" x 6'8"  
 2'10" x 6'8"  
 3'0" x 6'8"

**S880\_**  
 6  
 2'8" x 8'0"  
 2'10" x 8'0"  
 3'0" x 8'0"

**S80\_**  
 6  
 2'8" x 6'8"  
 2'10" x 6'8"  
 3'0" x 6'8"

**S206\_**  
 6  
 2'6" x 6'8"  
 2'8" x 6'8" ‡  
 2'10" x 6'8" ‡  
 3'0" x 6'8" ‡

**S81929P\_**  
 6  
 2'8" x 8'0"  
 2'10" x 8'0"  
 3'0" x 8'0"

**S6021\_**  
 6  
 2'6" x 6'8"  
 2'8" x 6'8" ‡  
 2'10" x 6'8" ‡  
 3'0" x 6'8" ‡

### Privacy & Textured Glass Options

Add the code to the blank in the style number for the desired door and glass combination. For details on glass options, see page 119.

**XE = Satin Etch Glass**  
**XC = Chord Glass**

**XJ = Chinchilla Glass**  
**XR = Rainglass**

**XN = Granite Glass**

\*Not recommended for use behind storm doors or to be painted dark colors, if exposed to direct sunlight.  
 Note: See page 273 for important product details that may help with your purchase decision.





S6041\_   
 2'8" x 6'8"   
 2'10" x 6'8"   
 3'0" x 6'8"



S104\_   
 2'8" x 6'8" ‡   
 2'10" x 6'8" ‡   
 3'0" x 6'8" ‡



S30\_   
 2'8" x 6'8"   
 2'10" x 6'8"   
 3'0" x 6'8"



S830\_   
 2'8" x 8'0"   
 2'10" x 8'0"   
 3'0" x 8'0"



S289\_   
 2'8" x 6'8"   
 2'10" x 6'8"   
 3'0" x 6'8"



S601\_   
 2'8" x 6'8"   
 2'10" x 6'8"   
 3'0" x 6'8"



S8600\_   
 2'8" x 8'0"   
 2'10" x 8'0"   
 3'0" x 8'0"



S9320\_   
 2'8" x 6'8"   
 2'10" x 6'8"   
 3'0" x 6'8"



S83120\_   
 2'8" x 8'0"   
 2'10" x 8'0"   
 3'0" x 8'0"



S708\_   
 2'8" x 6'8" ‡   
 2'10" x 6'8" ‡   
 3'0" x 6'8" ‡



S8708\_   
 2'8" x 8'0"   
 2'10" x 8'0"   
 3'0" x 8'0"



S256\_   
 2'8" x 6'8"   
 2'10" x 6'8"   
 3'0" x 6'8"



S296\_   
 2'6" x 6'8"   
 2'8" x 6'8" ‡   
 2'10" x 6'8" ‡   
 3'0" x 6'8" ‡



S896\_   
 2'6" x 8'0"   
 2'8" x 8'0"   
 2'10" x 8'0"   
 3'0" x 8'0"



S601\_SL   
 10" x 6'8"   
 12" x 6'8" †‡   
 14" x 6'8" †‡

S81086\_SL   
 12" x 8'0"   
 14" x 8'0"



S100\_SL   
 12" x 6'8"   
 14" x 6'8"



S8601\_SL   
 12" x 8'0"   
 14" x 8'0"



S751\_SL   
 12" x 6'8"   
 14" x 6'8"

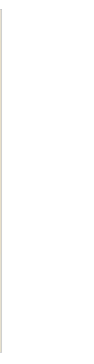

S880\_SL   
 12" x 8'0"   
 14" x 8'0"



S210\_SL   
 12" x 6'8"   
 14" x 6'8"



S85910\_SL   
 12" x 8'0"   
 14" x 8'0"

**Key**

No Stile Lines

Vented Sidelite (No Impact)  
 (6'6" & 6'8" only in 12" & 14")  
 (8'0" only in 14")

WBDR Options

WBDR / HVHZ Options

6'6" Height Available

7'0" Height Available

**Optional Dentil Shelf\***



4-Block Dentil Shelf  
 Available for all Craftsman-style  
 Smooth-Star doors.

# Internal Blinds

Note: Product images show exterior side of door.

## Fiber-Classic® Mahogany



|  |   |   |   |   |  |   |   |   |
|--|---|---|---|---|--|---|---|---|
| <b>FCM141</b><br>★<br>2'8" x 6'8"<br>2'10" x 6'8"<br>3'0" x 6'8" | <b>FCM8115</b><br>★<br>2'8" x 8'0"<br>2'10" x 8'0"<br>3'0" x 8'0" | <b>FCM1286</b><br>★<br>2'4" x 6'8" ▲<br>2'6" x 6'8" ▲‡<br>2'8" x 6'8" ▲‡<br>2'10" x 6'8" ▲‡<br>3'0" x 6'8" ▲‡ | <b>FCM81225</b><br>★<br>2'6" x 8'0"<br>2'8" x 8'0"<br>2'10" x 8'0"<br>3'0" x 8'0" | <b>FCM5425</b><br>★<br>2'8" x 6'8"<br>2'10" x 6'8"<br>3'0" x 6'8" | <b>FCM678</b><br>★<br>2'8" x 6'8"<br>2'10" x 6'8"<br>3'0" x 6'8" | <b>FCM8678</b><br>★<br>2'8" x 8'0"<br>2'10" x 8'0"<br>3'0" x 8'0" | <b>FCM6035</b><br>★<br>2'8" x 6'8"<br>2'10" x 6'8"<br>3'0" x 6'8" | <b>FCM6055</b><br>★<br>2'8" x 6'8"<br>2'10" x 6'8"<br>3'0" x 6'8" |
|--|---|---|---|---|--|---|---|---|



|   |   |  |   |   |   |  |   |
|---|---|--|---|---|---|--|---|
| <b>FCM116</b><br>★<br>2'6" x 6'8" ‡<br>2'8" x 6'8" ‡<br>2'10" x 7'0"<br>3'0" x 6'8" ‡ | <b>FCM1286SL</b><br>★<br>10" x 6'8"<br>12" x 6'8" ▲‡<br>14" x 6'8" ▲‡ | <b>FCM81225SL</b><br>★<br>12" x 8'0"<br>14" x 8'0" | <b>FCM8115SL</b><br>★<br>12" x 8'0"<br>14" x 8'0" | <b>FCM5425SL</b><br>★<br>12" x 6'8"<br>14" x 6'8" | <b>FCM8110SL</b><br>★<br>12" x 8'0"<br>14" x 8'0" | <b>FCM678SL</b><br>★<br>12" x 6'8"<br>14" x 6'8" | <b>FCM8678SL</b><br>★<br>12" x 8'0"<br>14" x 8'0" |
|---|---|--|---|---|---|--|---|

## Fiber-Classic® Oak



|  |  |  |  |   |  |  |  |  |
|--|--|--|--|---|--|--|--|--|
| <b>FC141</b><br>★<br>2'6" x 6'8"<br>2'8" x 6'8" ‡<br>2'10" x 6'8" ‡<br>3'0" x 6'8" ‡ | <b>81225P</b><br>★<br>2'8" x 8'0"<br>2'10" x 8'0"<br>3'0" x 8'0" | <b>1286</b><br>★<br>2'4" x 6'8" ▲<br>2'6" x 6'8" ▲‡<br>2'8" x 6'8" ▲‡<br>2'10" x 6'8" ▲‡<br>3'0" x 6'8" ▲‡ | <b>81225</b><br>★<br>2'6" x 8'0"<br>2'8" x 8'0"<br>2'10" x 8'0"<br>3'0" x 8'0" | <b>1964P</b><br>★<br>2'8" x 6'8"<br>2'10" x 6'8"<br>3'0" x 6'8" | <b>81964P</b><br>★<br>2'8" x 8'0"<br>2'10" x 8'0"<br>3'0" x 8'0" | <b>FC5425</b><br>★<br>2'8" x 6'8"<br>2'10" x 6'8"<br>3'0" x 6'8" | <b>FC678</b><br>★<br>2'6" x 6'8"<br>2'8" x 6'8" ‡<br>2'10" x 6'8" ‡<br>3'0" x 6'8" ‡ | <b>FC8678</b><br>★<br>2'8" x 8'0"<br>2'10" x 8'0"<br>3'0" x 8'0" |
|--|--|--|--|---|--|--|--|--|

\*Not recommended for use behind storm doors or to be painted dark colors, if exposed to direct sunlight.  
Note: See page 273 for important product details that may help with your purchase decision.



|   |  |   |  |   |  |  |   |
|---|--|---|--|---|--|--|---|
| <b>FC116</b><br>★<br>2'4" x 6'8"<br>2'6" x 6'8" ‡<br>2'8" x 6'8" ‡<br>2'10" x 6'8" ‡<br>3'0" x 6'8" ‡ | <b>FC8971</b><br>★<br>2'8" x 8'0"<br>2'10" x 8'0"<br>3'0" x 8'0" | <b>FC925</b><br>★<br>2'8" x 6'8"<br>2'10" x 6'8"<br>3'0" x 6'8" | <b>FC8972</b><br>★<br>2'8" x 8'0"<br>2'10" x 8'0"<br>3'0" x 8'0" | <b>FC141SL</b><br>★<br>10" x 6'8"<br>12" x 6'8"<br>14" x 6'8" | <b>81225PSL</b><br>★<br>12" x 8'0"<br>14" x 8'0" | <b>1286SL</b><br>★ ●<br>12" x 6'8" △ ‡<br>14" x 6'8" △ ‡ | <b>81225SL</b><br>★ ●<br>12" x 8'0"<br>14" x 8'0" |
|---|--|---|--|---|--|--|---|



|  |  |   |  |
|--|--|---|--|
| <b>FC5425SL</b><br>★<br>12" x 6'8"<br>14" x 6'8" | <b>81964PSL</b><br>★<br>12" x 8'0"<br>14" x 8'0" | <b>FC678SL</b><br>★<br>12" x 6'8"<br>14" x 6'8" | <b>FC8678SL</b><br>★<br>12" x 8'0"<br>14" x 8'0" |
|--|--|---|--|

## Smooth-Star®



|   |   |  |  |  |   |   |   |   |
|---|---|--|--|--|---|---|---|---|
| <b>S130</b><br>★<br>2'6" x 6'8" △<br>2'8" x 6'8" △ ‡<br>2'10" x 6'8" △ ‡<br>3'0" x 6'8" △ ‡ | <b>S829</b><br>★<br>2'6" x 8'0"<br>2'8" x 8'0"<br>2'10" x 8'0"<br>3'0" x 8'0" | <b>S6061</b><br>★ ●<br>2'4" x 6'8" △<br>2'6" x 6'8" △<br>2'8" x 6'8" △ ‡<br>2'10" x 6'8" △ ‡<br>3'0" x 6'8" △ ‡<br>3'6" x 6'8" | <b>S81225</b><br>★ ●<br>2'6" x 8'0"<br>2'8" x 8'0"<br>2'10" x 8'0"<br>3'0" x 8'0"<br>3'6" x 8'0" | <b>S682</b><br>★<br>2'8" x 6'8"<br>2'10" x 6'8"<br>3'0" x 6'8" | <b>S8682</b><br>★<br>2'8" x 8'0"<br>2'10" x 8'0"<br>3'0" x 8'0" | <b>S5425</b><br>★<br>2'8" x 6'8"<br>2'10" x 6'8"<br>3'0" x 6'8" | <b>S132</b><br>★<br>2'6" x 6'8"<br>2'8" x 6'8" ‡<br>2'10" x 6'8" ‡<br>3'0" x 6'8" ‡ | <b>S8132</b><br>★<br>2'8" x 8'0"<br>2'10" x 8'0"<br>3'0" x 8'0" |
|---|---|--|--|--|---|---|---|---|

**Internal Blinds** *Continues on next page.*

### Key

- No Stile Lines
- ★ Low-E Glass (LE)
- Vented Sidelite (No Impact)  
(6'6" & 6'8" only in 12" & 14")  
(8'0" only in 14")
- △ 6'6" Height Available
- ‡ 7'0" Height Available



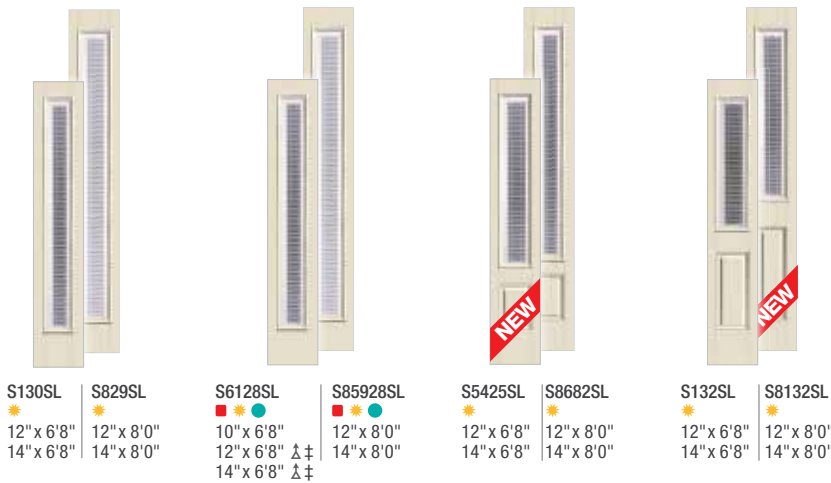

## Screen Vented Lites\*

Smooth-Star®



\*Features a gliding operation and sash locking system.

\*\*Not recommended for use behind storm doors or to be painted dark colors, if exposed to direct sunlight.

Note: See page 273 for important product details that may help with your purchase decision.

# Flush-Glazed Clear Glass with Divided Lites

Note: For details on divided lite options, see pages 120–121.

## Fiber-Classic® Oak

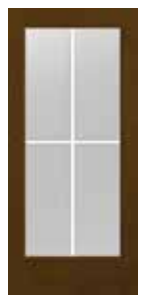

**FC1205**  
 ▲ ● ◆  
 2'6" x 6'8" ▲  
 2'8" x 6'8" ▲  
 2'10" x 6'6" ▲  
 3'0" x 6'8" ▲

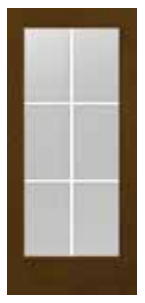

**FC1206**  
 ▲ ● ◆  
 2'6" x 6'8" ▲  
 2'8" x 6'8" ▲  
 2'10" x 6'6" ▲  
 3'0" x 6'8" ▲



**FC1207**  
 ▲ ● ◆ ◆  
 2'6" x 6'8" ▲  
 2'8" x 6'8" ▲  
 2'10" x 6'6" ▲  
 3'0" x 6'8" ▲



**2010**  
 ▲ ● ◆ ◆ ◆  
 2'6" x 6'8" ▲  
 2'8" x 6'8" ▲  
 2'10" x 6'6" ▲  
 3'0" x 6'8" ▲

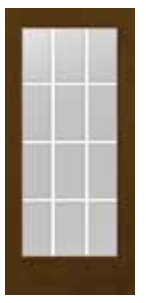

**FC1204**  
 ▲ ● ◆ ◆  
 2'6" x 6'8" ▲  
 2'8" x 6'8" ▲  
 2'10" x 6'6" ▲  
 3'0" x 6'8" ▲



**2050**  
 ▲ ● ◆ ◆ ◆  
 2'6" x 6'8" ▲  
 2'8" x 6'8" ▲  
 2'10" x 6'6" ▲  
 3'0" x 6'8" ▲



**8000-12**  
 ▲ ● ◆ ◆ ◆  
 2'6" x 8'0" ▲  
 2'8" x 8'0" ▲  
 2'10" x 8'0" ▲  
 3'0" x 8'0" ▲

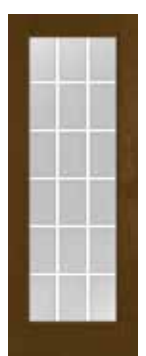

**8000-18**  
 ▲ ● ◆ ◆ ◆  
 2'0" x 8'0" ▲  
 2'6" x 8'0" ▲  
 2'8" x 8'0" ▲  
 2'10" x 8'0" ▲  
 3'0" x 8'0" ▲



**2150**  
 ▲ ● ◆ ◆ ◆  
 2'6" x 6'8" ▲  
 2'8" x 6'8" ▲  
 3'0" x 6'8" ▲



**FC1205SL**  
 ▲ ● ◆ ◆  
 12" x 6'8" ▲  
 14" x 6'8" ▲



**FC1206SL**  
 ▲ ● ◆ ◆  
 12" x 6'8" ▲  
 14" x 6'8" ▲



**FC1204SL**  
 ▲ ● ◆ ◆  
 12" x 6'8" ▲  
 14" x 6'8" ▲



**2050SL**  
 ▲ ● ◆ ◆ ◆  
 12" x 6'8" ▲  
 14" x 6'8" ▲



**FC02000-2C**  
 ▲ ● ◆ ◆ ◆  
 2'0" x 6'8" ▲  
 2'6" x 6'8" ▲  
 2'8" x 6'8" ▲  
 2'10" x 6'6" ▲  
 3'0" x 6'8" ▲



**FC082000-2C**  
 ▲ ● ◆ ◆ ◆  
 2'0" x 8'0" ▲  
 2'6" x 8'0" ▲  
 2'8" x 8'0" ▲  
 2'10" x 8'0" ▲  
 3'0" x 8'0" ▲



**FC02000-3C**  
 ▲ ● ◆ ◆ ◆  
 2'0" x 6'8" ▲  
 2'6" x 6'8" ▲  
 2'8" x 6'8" ▲  
 2'10" x 6'6" ▲  
 3'0" x 6'8" ▲



**FC082000-3C**  
 ▲ ● ◆ ◆ ◆  
 2'0" x 8'0" ▲  
 2'6" x 8'0" ▲  
 2'8" x 8'0" ▲  
 2'10" x 8'0" ▲  
 3'0" x 8'0" ▲



**FC02000-4C**  
 ▲ ● ◆ ◆ ◆  
 2'0" x 6'8" ▲  
 2'6" x 6'8" ▲  
 2'8" x 6'8" ▲  
 2'10" x 6'6" ▲  
 3'0" x 6'8" ▲



**FC082000-4C**  
 ▲ ● ◆ ◆ ◆  
 2'0" x 8'0" ▲  
 2'6" x 8'0" ▲  
 2'8" x 8'0" ▲  
 2'10" x 8'0" ▲  
 3'0" x 8'0" ▲

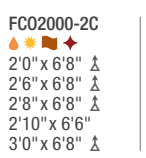

**FC02000-6C**  
 ▲ ● ◆ ◆ ◆  
 2'0" x 6'8" ▲  
 2'6" x 6'8" ▲  
 2'8" x 6'8" ▲  
 2'10" x 6'6" ▲  
 3'0" x 6'8" ▲

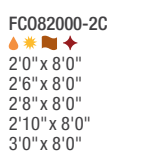

**FC082000-6C**  
 ▲ ● ◆ ◆ ◆  
 2'0" x 8'0" ▲  
 2'6" x 8'0" ▲  
 2'8" x 8'0" ▲  
 2'10" x 8'0" ▲  
 3'0" x 8'0" ▲

Flush-Glazed Clear Glass with Divided Lites *Continues on next page.*















### Key

- No Stile Lines
- ▲ Flush-Glazed Glass (FG)
- ☀ Low-E Glass (LE)
- 🗡 Simulated Divided Lites (SDL)\*\*
- ◆ Flat White Grilles Between Glass Only (GBGFW)
- ◆ Flat or Contour, White or Color Grilles Between Glass (GBGF / GBGC)
- Removable Wood Grilles (RG)
- Vented Sidelite (No Impact)  
(6'6" & 6'8" only in 12" & 14")  
(8'0" only in 14")
- ▲ 6'6" Height Available
- ‡ 7'0" Height Available



**Flush-Glazed Clear Glass with Divided Lites** *Continued*

|   |  |  |   |  |
|---|--|--|---|--|
|   |    |    |   |    |
| <p><b>2009</b><br/>   <br/>                     2'0" x 6'8" <math>\Delta</math><br/>                     2'6" x 6'8" <math>\Delta</math><br/>                     2'8" x 6'8" <math>\Delta</math><br/>                     2'10" x 6'6" <math>\Delta</math><br/>                     3'0" x 6'8" <math>\Delta</math></p> | <p><b>8000-9</b><br/>   <br/>                     2'6" x 8'0" <math>\Delta</math><br/>                     2'8" x 8'0" <math>\Delta</math><br/>                     2'10" x 8'0" <math>\Delta</math><br/>                     3'0" x 8'0" <math>\Delta</math></p> | <p><b>FC1409</b><br/>   <br/>                     2'6" x 6'8" <math>\Delta</math><br/>                     2'8" x 6'8" <math>\Delta</math><br/>                     3'0" x 6'8" <math>\Delta</math></p> | <p><b>2009SL</b><br/>   <br/>                     12" x 6'8" <math>\Delta</math><br/>                     14" x 6'8" <math>\Delta</math></p> | <p><b>FC5700</b><br/>   <br/>                     2'6" x 6'8" <math>\Delta</math><br/>                     2'8" x 6'8" <math>\Delta</math><br/>                     2'10" x 6'6" <math>\Delta</math><br/>                     3'0" x 6'8" <math>\Delta</math></p> |

|   |   |   |   |
|---|---|---|---|
|    |    |    |    |
| <p><b>FC85720</b><br/>   <br/>                     2'6" x 6'8" <math>\Delta</math><br/>                     2'8" x 6'8" <math>\Delta</math><br/>                     2'10" x 6'6" <math>\Delta</math><br/>                     3'0" x 6'8" <math>\Delta</math></p> | <p><b>FC5700SL</b><br/>   <br/>                     12" x 6'8" <math>\Delta</math><br/>                     14" x 6'8" <math>\Delta</math></p> | <p><b>FC5710SL</b><br/>   <br/>                     12" x 6'8" <math>\Delta</math><br/>                     14" x 6'8" <math>\Delta</math></p> | <p><b>FC5720SL</b><br/>   <br/>                     12" x 6'8" <math>\Delta</math><br/>                     14" x 6'8" <math>\Delta</math></p> |

\*Available 2nd quarter 2017. To learn more about availability, call 1-800-323-3533.  
 \*\*Not recommended for use behind storm doors or to be painted dark colors, if exposed to direct sunlight.  
 Note: See page 273 for important product details that may help with your purchase decision.  
 Top: Fiber-Classic Oak Collection, Clear Glass with SDLs, Door – FC5710, Sidelite – FC5710SL



# Smooth-Star®

|   |   |   |   |   |   |  |  |
|---|---|---|---|---|---|--|--|
|   |   |   |   |   |   |  |  |
| <b>S1205</b><br><br>2'6" x 6'8" ⚠<br>2'8" x 6'8" ⚠<br>2'10" x 6'8" ⚠<br>3'0" x 6'8" ⚠ | <b>S1206</b><br><br>2'6" x 6'8" ⚠<br>2'8" x 6'8" ⚠<br>2'10" x 6'8" ⚠<br>3'0" x 6'8" ⚠ | <b>S1207</b><br><br>2'6" x 6'8" ⚠<br>2'8" x 6'8" ⚠<br>2'10" x 6'8" ⚠<br>3'0" x 6'8" ⚠ | <b>S2010</b><br><br>2'6" x 6'8" ⚠<br>2'8" x 6'8" ⚠<br>2'10" x 6'8" ⚠<br>3'0" x 6'8" ⚠ | <b>S1204</b><br><br>2'6" x 6'8" ⚠<br>2'8" x 6'8" ⚠<br>2'10" x 6'8" ⚠<br>3'0" x 6'8" ⚠ | <b>S2050</b><br><br>2'6" x 6'8" ⚠<br>2'8" x 6'8" ⚠<br>2'10" x 6'8" ⚠<br>3'0" x 6'8" ⚠ | <b>S8000-12</b><br><br>2'6" x 8'0"<br>2'8" x 8'0"<br>2'10" x 8'0"<br>3'0" x 8'0" | <b>S8000-18</b><br><br>2'6" x 8'0"<br>2'8" x 8'0"<br>2'10" x 8'0"<br>3'0" x 8'0" |

|   |  |   |  |   |  |   |  |  |
|---|--|---|--|---|--|---|--|--|
|   |  |   |  |   |  |   |  |  |
| <b>S2103</b><br><br>2'6" x 6'8"<br>2'8" x 6'8"<br>2'10" x 6'8"<br>3'0" x 6'8" | <b>S82103</b><br><br>2'6" x 8'0"<br>2'8" x 8'0"<br>2'10" x 8'0"<br>3'0" x 8'0" | <b>S2104</b><br><br>2'6" x 6'8"<br>2'8" x 6'8"<br>2'10" x 6'8"<br>3'0" x 6'8" | <b>S82104</b><br><br>2'6" x 8'0"<br>2'8" x 8'0"<br>2'10" x 8'0"<br>3'0" x 8'0" | <b>S2105</b><br><br>2'6" x 6'8"<br>2'8" x 6'8"<br>2'10" x 6'8"<br>3'0" x 6'8" | <b>S82105</b><br><br>2'6" x 8'0"<br>2'8" x 8'0"<br>2'10" x 8'0"<br>3'0" x 8'0" | <b>S2250</b><br><br>2'6" x 6'8"<br>2'8" x 6'8"<br>2'10" x 6'8"<br>3'0" x 6'8" | <b>S82250</b><br><br>2'6" x 8'0"<br>2'8" x 8'0"<br>2'10" x 8'0"<br>3'0" x 8'0" | <b>S82106</b><br><br>2'6" x 8'0"<br>2'8" x 8'0"<br>2'10" x 8'0"<br>3'0" x 8'0" |

|  |   |  |  |  |  |  |  |  |  |
|--|---|--|--|--|--|--|--|--|--|
|  |   |  |  |  |  |  |  |  |  |
| <b>S82107</b><br><br>2'6" x 8'0"<br>2'8" x 8'0"<br>2'10" x 8'0"<br>3'0" x 8'0" | <b>S2150</b><br><br>2'6" x 6'8"<br>2'8" x 6'8"<br>3'0" x 6'8" | <b>S1205SL</b><br><br>10" x 6'8" ⚠<br>12" x 6'8" ⚠<br>14" x 6'8" ⚠ | <b>S1206SL</b><br><br>10" x 6'8" ⚠<br>12" x 6'8" ⚠<br>14" x 6'8" ⚠ | <b>S1204SL</b><br><br>10" x 6'8" ⚠<br>12" x 6'8" ⚠<br>14" x 6'8" ⚠ | <b>S2010SL</b><br><br>10" x 6'8" ⚠<br>12" x 6'8" ⚠<br>14" x 6'8" ⚠ | <b>S84886SL*</b><br><br>12" x 8'0"<br>14" x 8'0" | <b>S2103SL</b><br><br>12" x 6'8"<br>14" x 6'8" | <b>S2104SL</b><br><br>12" x 6'8"<br>14" x 6'8" | <b>S92SL</b><br><br>12" x 6'8"<br>14" x 6'8" |

**Flush-Glazed Clear Glass with Divided Lites** *Continues on next page.*

## Key

- Low-E Glass (LE)**
- Flush-Glazed Glass (FG)**
- Simulated Divided Lites (SDL)\*\***
- Simulated Divided Lites (SDLF1)\*\***
- Simulated Divided Lites (SDLF2)\*\***
- Flat or Contour, White or Color Grilles Between Glass (GBGF / GBGC)**
- Removable Wood Grilles (RG)**
- Vented Sidelite (No Impact)**  
(6'6" & 6'8" only in 12" & 14")  
(8'0" only in 14")
- 6'6" Height Available**

## Flush-Glazed Clear Glass with Divided Lites *Continued*



**S2000-2C**  
 ▲ ★ ■ ◆  
 2'0" x 6'8" ▲  
 2'6" x 6'8" ▲  
 2'8" x 6'8" ▲  
 2'10" x 6'8" ▲  
 3'0" x 6'8" ▲

**S82000-2C**  
 ▲ ★ ■ ◆  
 2'0" x 8'0" ▲  
 2'6" x 8'0" ▲  
 2'8" x 8'0" ▲  
 2'10" x 8'0" ▲  
 3'0" x 8'0" ▲

**S2000-3C**  
 ▲ ★ ■ ◆  
 2'0" x 6'8" ▲  
 2'6" x 6'8" ▲  
 2'8" x 6'8" ▲  
 2'10" x 6'8" ▲  
 3'0" x 6'8" ▲

**S82000-3C**  
 ▲ ★ ■ ◆  
 2'0" x 8'0" ▲  
 2'6" x 8'0" ▲  
 2'8" x 8'0" ▲  
 2'10" x 8'0" ▲  
 3'0" x 8'0" ▲

**S2000-4C**  
 ▲ ★ ■ ◆  
 2'0" x 6'8" ▲  
 2'6" x 6'8" ▲  
 2'8" x 6'8" ▲  
 2'10" x 6'8" ▲  
 3'0" x 6'8" ▲

**S82000-4C**  
 ▲ ★ ■ ◆  
 2'0" x 8'0" ▲  
 2'6" x 8'0" ▲  
 2'8" x 8'0" ▲  
 2'10" x 8'0" ▲  
 3'0" x 8'0" ▲

**S2000-6C**  
 ▲ ★ ■ ◆  
 2'0" x 6'8" ▲  
 2'6" x 6'8" ▲  
 2'8" x 6'8" ▲  
 2'10" x 6'8" ▲  
 3'0" x 6'8" ▲

**S82000-6C**  
 ▲ ★ ■ ◆  
 2'0" x 8'0" ▲  
 2'6" x 8'0" ▲  
 2'8" x 8'0" ▲  
 2'10" x 8'0" ▲  
 3'0" x 8'0" ▲

**S82112**  
 ▲ ★ ■ ◆  
 2'6" x 8'0" ▲  
 2'8" x 8'0" ▲  
 2'10" x 8'0" ▲  
 3'0" x 8'0" ▲



**S82113**  
 ▲ ★ ■ ◆  
 2'6" x 8'0" ▲  
 2'8" x 8'0" ▲  
 2'10" x 8'0" ▲  
 3'0" x 8'0" ▲



**S82114**  
 ▲ ★ ■ ◆  
 2'6" x 8'0" ▲  
 2'8" x 8'0" ▲  
 2'10" x 8'0" ▲  
 3'0" x 8'0" ▲



**S82116**  
 ▲ ★ ■ ◆  
 2'6" x 8'0" ▲  
 2'8" x 8'0" ▲  
 2'10" x 8'0" ▲  
 3'0" x 8'0" ▲



**S4812**  
 ▲ ★ ■  
 2'8" x 6'8" ▲  
 2'10" x 6'8" ▲  
 3'0" x 6'8" ▲



**S84812**  
 ▲ ★ ■  
 2'8" x 8'0" ▲  
 2'10" x 8'0" ▲  
 3'0" x 8'0" ▲

**S4813**  
 ▲ ★ ■  
 2'8" x 6'8" ▲  
 2'10" x 6'8" ▲  
 3'0" x 6'8" ▲

**S84813**  
 ▲ ★ ■  
 2'8" x 8'0" ▲  
 2'10" x 8'0" ▲  
 3'0" x 8'0" ▲



\*Available 2nd quarter 2017. To learn more about availability, call 1-800-323-3533.

\*\*Not recommended for use behind storm doors or to be painted dark colors, if exposed to direct sunlight.

Note: See page 273 for important product details that may help with your purchase decision.

Top: Smooth-Star, Low-E Glass with SDLs, Door – S84816, Sidelites – S8000SL



**S4814**  
 ▲ 🔥 🔦 🔦  
 2'8" x 6'8" ▲  
 2'10" x 6'8" ▲  
 3'0" x 6'8" ▲

**S84814**  
 ▲ 🔥 🔦 🔦  
 2'8" x 8'0" ▲  
 2'10" x 8'0" ▲  
 3'0" x 8'0" ▲



**S4816**  
 ▲ 🔥 🔦 🔦  
 2'8" x 6'8" ▲  
 2'10" x 6'8" ▲  
 3'0" x 6'8" ▲

**S84816**  
 ▲ 🔥 🔦 🔦  
 2'8" x 8'0" ▲  
 2'10" x 8'0" ▲  
 3'0" x 8'0" ▲



**S2000SL-2C**  
 ▲ 🔥 🔦 🔦 🔦 🔦  
 10" x 6'8" ▲  
 12" x 6'8" ▲  
 14" x 6'8" ▲



**S2000SL-4C**  
 ▲ 🔥 🔦 🔦 🔦 🔦  
 10" x 6'8" ▲  
 12" x 6'8" ▲  
 14" x 6'8" ▲



**S4812SL**  
 ▲ 🔥 🔦 🔦  
 12" x 6'8" ▲  
 14" x 6'8" ▲

**S84812SL**  
 ▲ 🔥 🔦 🔦  
 12" x 8'0" ▲  
 14" x 8'0" ▲

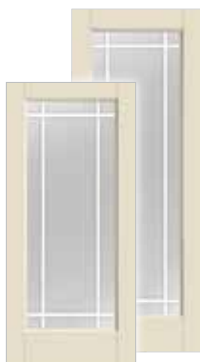

**S2009**  
 ▲ 🔥 🔦 🔦 🔦  
 2'0" x 6'8" ▲  
 2'6" x 6'8" ▲  
 2'8" x 6'8" ▲  
 2'10" x 6'8" ▲  
 3'0" x 6'8" ▲

**S8000-9**  
 ▲ 🔥 🔦 🔦 🔦  
 2'0" x 8'0" ▲  
 2'6" x 8'0" ▲  
 2'8" x 8'0" ▲  
 2'10" x 8'0" ▲  
 3'0" x 8'0" ▲



**S1401**  
 ▲ 🔥 🔦 🔦  
 2'6" x 6'8" ▲  
 2'8" x 6'8" ▲  
 2'10" x 6'8" ▲  
 3'0" x 6'8" ▲

**S81401**  
 ▲ 🔥 🔦 🔦 🔦  
 2'6" x 8'0" ▲  
 2'8" x 8'0" ▲  
 2'10" x 8'0" ▲  
 3'0" x 8'0" ▲



**S1409**  
 ▲ 🔥 🔦 🔦  
 2'6" x 6'8" ▲  
 2'8" x 6'8" ▲  
 3'0" x 6'8" ▲



**S2009SL**  
 ▲ 🔥 🔦 🔦 🔦  
 10" x 6'8" ▲  
 12" x 6'8" ▲  
 14" x 6'8" ▲



**S1401SL**  
 ▲ 🔥 🔦 🔦  
 12" x 6'8" ▲  
 14" x 6'8" ▲



**S5700**  
 ▲ 🔥 🔦 🔦  
 2'6" x 6'8" ▲  
 2'8" x 6'8" ▲  
 2'10" x 6'8" ▲  
 3'0" x 6'8" ▲

**S85700**  
 ▲ 🔥 🔦 🔦  
 2'6" x 8'0" ▲  
 2'8" x 8'0" ▲  
 2'10" x 8'0" ▲  
 3'0" x 8'0" ▲



**S5710**  
 ▲ 🔥 🔦 🔦  
 2'6" x 6'8" ▲  
 2'8" x 6'8" ▲  
 2'10" x 6'8" ▲  
 3'0" x 6'8" ▲

**S85710**  
 ▲ 🔥 🔦 🔦  
 2'6" x 8'0" ▲  
 2'8" x 8'0" ▲  
 2'10" x 8'0" ▲  
 3'0" x 8'0" ▲



**S5720**  
 ▲ 🔥 🔦 🔦  
 2'6" x 6'8" ▲  
 2'8" x 6'8" ▲  
 2'10" x 6'8" ▲  
 3'0" x 6'8" ▲

**S85720**  
 ▲ 🔥 🔦 🔦  
 2'6" x 8'0" ▲  
 2'8" x 8'0" ▲  
 2'10" x 8'0" ▲  
 3'0" x 8'0" ▲



**S5730**  
 ▲ 🔥 🔦 🔦  
 2'6" x 6'8" ▲  
 2'8" x 6'8" ▲  
 2'10" x 6'8" ▲  
 3'0" x 6'8" ▲

**S85730**  
 ▲ 🔥 🔦 🔦  
 2'6" x 8'0" ▲  
 2'8" x 8'0" ▲  
 2'10" x 8'0" ▲  
 3'0" x 8'0" ▲



**S5700SL**  
 ▲ 🔥 🔦 🔦 🔦  
 10" x 6'8" ▲  
 12" x 6'8" ▲  
 14" x 6'8" ▲

**S85700SL\***  
 ▲ 🔥 🔦 🔦 🔦  
 12" x 8'0" ▲  
 14" x 8'0" ▲

**Flush-Glazed Clear Glass with Divided Lites** *Continues on next page.*

**Key**

- ▲ Flush-Glazed Glass (FG)
- 🔦 Low-E Glass (LE)
- 🔦 Simulated Divided Lites (SDL)\*\*
- 🔦 Simulated Divided Lites (SDLF1)\*\*

- 🔦 Simulated Divided Lites (SDLF2)\*\*
- 🔦 Flat White Grilles Between Glass Only (GBGFW)
- 🔦 Flat or Contour, White or Color Grilles Between Glass (GBGF / GBGC)

- ➡ Removable Wood Grilles (RG)
- Vented Sidelite (No Impact)  
(6'6" & 6'8" only in 12" & 14")  
(8'0" only in 14")
- ▲ 6'6" Height Available

**Optional Dentil Shelf\*\***



**4-Block Dentil Shelf**  
 Available for all Craftsman-style Smooth-Star doors.



## Flush-Glazed Clear Glass with Divided Lites *Continued*

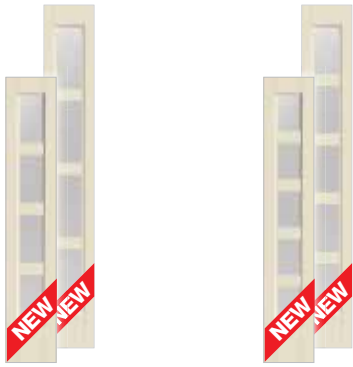

**S5710SL** | **S85710SL\***  
 ▲ ▲ ▲ ▲ ▲ ▲  
 10" x 6'8" | 12" x 8'0"  
 12" x 6'8" | 14" x 8'0"  
 14" x 6'8"

**S5720SL** | **S85720SL\***  
 ▲ ▲ ▲ ▲ ▲ ▲  
 10" x 6'8" | 12" x 8'0"  
 12" x 6'8" | 14" x 8'0"  
 14" x 6'8"



## Flush-Glazed Clear Glass

### Fiber-Classic® Oak



**2000** | **8000**  
 ▲ ▲ ▲ ▲ ▲ ▲  
 2'0" x 6'8" ▲ | 2'0" x 8'0"  
 2'6" x 6'8" ▲ | 2'6" x 8'0"  
 2'8" x 6'8" ▲ | 2'8" x 8'0"  
 2'10" x 6'6" ▲ | 2'10" x 8'0"  
 3'0" x 6'8" ▲ | 3'0" x 8'0"

**2100** | **2000SL**  
 ▲ ▲ ▲ ▲ ▲ ▲  
 2'6" x 6'8" | 12" x 6'8"  
 2'8" x 6'8" | 14" x 6'8"  
 3'0" x 6'8"

### Smooth-Star®



**S2000** | **S8000**  
 ▲ ▲ ▲ ▲ ▲ ▲  
 2'0" x 6'8" ▲ | 2'0" x 8'0"  
 2'6" x 6'8" ▲ | 2'6" x 8'0"  
 2'8" x 6'8" ▲ | 2'8" x 8'0"  
 2'10" x 6'8" ▲ | 2'10" x 8'0"  
 3'0" x 6'8" ▲ | 3'0" x 8'0"

**S2200** | **S82200**  
 ▲ ▲ ▲ ▲ ▲ ▲  
 2'6" x 6'8" | 2'6" x 8'0"  
 2'8" x 6'8" | 2'8" x 8'0"  
 2'10" x 6'8" | 2'10" x 8'0"  
 3'0" x 6'8" | 3'0" x 8'0"

**S2100**  
 ▲ ▲ ▲ ▲ ▲ ▲  
 2'6" x 6'8"  
 2'8" x 6'8"  
 3'0" x 6'8"



**S4810** | **S84810**  
 ▲ ▲ ▲ ▲ ▲ ▲  
 2'8" x 6'8" | 2'8" x 8'0"  
 2'10" x 6'8" | 2'10" x 8'0"  
 3'0" x 6'8" | 3'0" x 8'0"

**S2000SL** | **S8000SL\***  
 ▲ ▲ ▲ ▲ ▲ ▲  
 10" x 6'8" ▲ | 12" x 8'0"  
 12" x 6'8" ▲ | 14" x 8'0"  
 14" x 6'8"

**S90SL**  
 ▲ ▲ ▲ ▲ ▲ ▲  
 12" x 6'8"  
 14" x 6'8"

**S4810SL** | **S84810SL**  
 ▲ ▲ ▲ ▲ ▲ ▲  
 12" x 6'8" | 12" x 8'0"  
 14" x 6'8" | 14" x 8'0"

\*Available 2nd quarter 2017. To learn more about availability, call 1-800-323-3533.

\*\*Not recommended for use behind storm doors or to be painted dark colors, if exposed to direct sunlight.

Note: See page 273 for important product details that may help with your purchase decision.

Top: Smooth-Star, Satin Etch Glass with SDLs, Door – S5710XE, Sidelite – S5710XESL

# Clear Glass with Divided Lites

Note: For details on divided lite options, see pages 120-121.

## Fiber-Classic® Mahogany



**FCM1209**  
 ☀️ ♦️  
 2'8" x 6'8"  
 2'10" x 6'8"  
 3'0" x 6'8"



**FCM1201**  
 ■ ☀️ ♦️  
 2'4" x 6'8" △  
 2'6" x 6'8" △ ‡  
 2'8" x 6'8" △ ‡  
 2'10" x 6'8" △ ‡  
 3'0" x 6'8" △ ‡



**FCM1211**  
 ☀️ ♦️  
 2'8" x 6'8"  
 2'10" x 6'8"  
 3'0" x 6'8"



**FCM1202**  
 ■ ☀️ ♦️  
 2'4" x 6'8" △  
 2'6" x 6'8" △ ‡  
 2'8" x 6'8" △ ‡  
 2'10" x 6'8" △ ‡  
 3'0" x 6'8" △ ‡

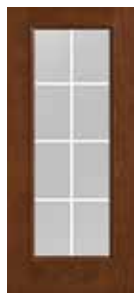

**FCM1212**  
 ☀️ ♦️  
 2'8" x 6'8"  
 2'10" x 6'8"  
 3'0" x 6'8"

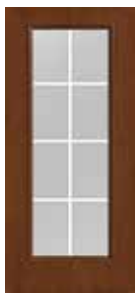

**FCM1203**  
 ■ ☀️ ♦️  
 2'4" x 6'8" △  
 2'6" x 6'8" △ ‡  
 2'8" x 6'8" △ ‡  
 2'10" x 6'8" △ ‡  
 3'0" x 6'8" △ ‡



**FCM138**  
 ☀️ ■ ♦️ > 6  
 2'8" x 6'8"  
 2'10" x 6'8"  
 3'0" x 6'8"



**FCM1285**  
 ■ ☀️ ■ > 6  
 2'4" x 6'8" △  
 2'6" x 6'8" △ ‡  
 2'8" x 6'8" △ ‡  
 2'10" x 6'8" △ ‡  
 3'0" x 6'8" △ ‡

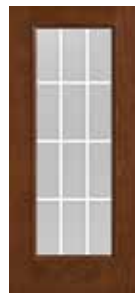

**FCM1208**  
 ☀️ 6  
 2'8" x 6'8"  
 2'10" x 6'8"  
 3'0" x 6'8"

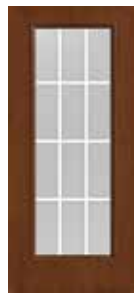

**FCM1200**  
 ■ ☀️ ♦️ 6  
 2'4" x 6'8" △  
 2'6" x 6'8" △ ‡  
 2'8" x 6'8" △ ‡  
 2'10" x 6'8" △ ‡  
 3'0" x 6'8" △ ‡



**FCM18**  
 ☀️ ■ > 6  
 2'8" x 6'8"  
 2'10" x 6'8"  
 3'0" x 6'8"



**FCM1284**  
 ■ ☀️ ■ > 6  
 2'4" x 6'8" △  
 2'6" x 6'8" △ ‡  
 2'8" x 6'8" △ ‡  
 2'10" x 6'8" △ ‡  
 3'0" x 6'8" △ ‡



**FCM828**  
 ☀️ 6  
 2'8" x 8'0"  
 2'10" x 8'0"  
 3'0" x 8'0"



**FCM81828**  
 ■ ☀️ ♦️ 6  
 2'6" x 8'0"  
 2'8" x 8'0"  
 2'10" x 8'0"  
 3'0" x 8'0"



**FCM81208P**  
 ☀️ ♦️ 6  
 2'8" x 8'0"  
 2'10" x 8'0"  
 3'0" x 8'0"



**FCM81829**  
 ■ ☀️ ♦️ 6  
 2'6" x 8'0"  
 2'8" x 8'0"  
 2'10" x 8'0"  
 3'0" x 8'0"



**FCM2106**  
 ☀️ ♦️  
 2'8" x 6'8"  
 2'10" x 6'8"  
 3'0" x 6'8"



**FCM2107**  
 ☀️ 6  
 2'8" x 6'8"  
 2'10" x 6'8"  
 3'0" x 6'8"



**FCM2108**  
 ☀️ ♦️  
 2'8" x 6'8"  
 2'10" x 6'8"  
 3'0" x 6'8"



**FCM82**  
 ☀️ ■ > 6  
 2'8" x 6'8"  
 2'10" x 6'8"  
 3'0" x 6'8"



**FCM63**  
 ☀️ >  
 2'8" x 6'8"  
 2'10" x 6'8"  
 3'0" x 6'8"

Clear Glass with Divided Lites *Continues on next page.*

**Key**

- No Stile Lines
- 🔥 Flush-Glazed Glass (FG)
- ☀️ Low-E Glass (LE)
- 🪟 Simulated Divided Lites (SDL)\*\*
- 🪟 Simulated Divided Lites (SDLF2)\*\*

- ♦️ Flat or Contour, White or Color Grilles Between Glass (GBGF / GBGC)
- Removable Wood Grilles (RG)
- Vented Sidelite (No Impact) (6'6" & 6'8" only in 12" & 14") (8'0" only in 14")

- 🌀 WBDR / HVHZ Options
- △ 6'6" Height Available
- ‡ 7'0" Height Available

**Optional Dentil Shelf\*\***



**Clear Glass with Divided Lites** *Continued*



|  |   |  |  |  |  |  |
|--|---|--|--|--|--|--|
| <b>FCM6097</b><br>☀️➡️<br>2'8" x 6'8"<br>2'10" x 6'8"<br>3'0" x 6'8" | <b>FCM811</b><br>☀️➡️<br>2'8" x 6'8"<br>2'10" x 6'8"<br>3'0" x 6'8" | <b>FCM8322</b><br>☀️⬆️<br>2'8" x 8'0"<br>2'10" x 8'0"<br>3'0" x 8'0" | <b>FCM8323</b><br>☀️⬆️⬅️<br>2'8" x 8'0"<br>2'10" x 8'0"<br>3'0" x 8'0" | <b>FCM8324</b><br>☀️⬆️<br>2'8" x 8'0"<br>2'10" x 8'0"<br>3'0" x 8'0" | <b>FCM65</b><br>☀️⬆️➡️⬅️⬆️<br>2'8" x 6'8"<br>2'10" x 6'8"<br>3'0" x 6'8" | <b>FCM6022</b><br>☀️⬆️➡️⬅️⬆️<br>2'8" x 6'8"<br>2'10" x 6'8"<br>3'0" x 6'8" |
|--|---|--|--|--|--|--|



|  |  |   |  |  |  |  |   |  |   |
|--|--|---|--|--|--|--|---|--|---|
| <b>FCM6042</b><br>☀️⬆️➡️⬅️⬆️<br>2'8" x 6'8"<br>2'10" x 6'8"<br>3'0" x 6'8" | <b>FCM8321</b><br>☀️⬆️⬅️<br>2'8" x 8'0"<br>2'10" x 8'0"<br>3'0" x 8'0" | <b>FCM752</b><br>☀️⬆️⬆️<br>2'8" x 6'8"<br>2'10" x 6'8"<br>3'0" x 6'8" | <b>FCM8752</b><br>☀️⬆️⬆️<br>2'8" x 8'0"<br>2'10" x 8'0"<br>3'0" x 8'0" | <b>FCM1201SL</b><br>☀️⬆️⬆️⬆️<br>10" x 6'8"<br>12" x 6'8" Δ ‡<br>14" x 6'8" Δ ‡ | <b>FCM1202SL</b><br>☀️⬆️⬆️⬆️<br>10" x 6'8"<br>12" x 6'8" Δ ‡<br>14" x 6'8" Δ ‡ | <b>FCM1200SL</b><br>☀️⬆️⬆️⬆️⬆️<br>10" x 6'8"<br>12" x 6'8" Δ ‡<br>14" x 6'8" Δ ‡ | <b>FCM12102SL</b><br>☀️⬆️⬆️⬆️⬆️⬆️<br>10" x 6'8"<br>12" x 6'8" Δ ‡<br>14" x 6'8" Δ ‡ | <b>FCM81208PSL</b><br>☀️⬆️⬆️<br>12" x 8'0"<br>14" x 8'0" | <b>FCM81208SL</b><br>☀️⬆️⬆️⬆️⬆️<br>12" x 8'0"<br>14" x 8'0" |
|--|--|---|--|--|--|--|---|--|---|



|  |  |  |  |  |  |  |  |  |  |  |
|--|--|--|--|--|--|--|--|--|--|--|
| <b>FCM1089SL</b><br>☀️⬆️<br>12" x 6'8"<br>14" x 6'8" | <b>FCM8311SL</b><br>☀️⬆️<br>12" x 8'0"<br>14" x 8'0" | <b>FCM2101SL</b><br>☀️⬆️⬆️<br>12" x 6'8"<br>14" x 6'8" | <b>FCM8313SL</b><br>☀️⬆️⬆️<br>12" x 8'0"<br>14" x 8'0" | <b>FCM92SL</b><br>☀️⬆️⬆️⬆️<br>12" x 6'8" | <b>FCM8310SL</b><br>☀️⬆️⬆️<br>12" x 8'0"<br>14" x 8'0" | <b>FCM8101SL</b><br>☀️⬆️⬆️⬆️⬆️<br>12" x 8'0"<br>14" x 8'0" | <b>FCM8675SL</b><br>☀️⬆️<br>12" x 8'0"<br>14" x 8'0" | <b>FCM65SL</b><br>☀️⬆️⬆️⬆️⬆️<br>12" x 6'8"<br>14" x 6'8" | <b>FCM7125SL</b><br>☀️⬆️⬆️<br>12" x 8'0"<br>14" x 8'0" | <b>FCM3487SL</b><br>☀️⬆️⬆️⬆️<br>12" x 8'0"<br>14" x 8'0" |
|--|--|--|--|--|--|--|--|--|--|--|

\*2'0" frames do not have simulated divided lites option.  
 \*\*Not recommended for use behind storm doors or to be painted dark colors, if exposed to direct sunlight.  
 Note: See page 273 for important product details that may help with your purchase decision.





**FCM3000-2C**  
 \* \* \* \*  
 2'8" x 6'8"  
 2'10" x 6'8"  
 3'0" x 6'8"



**FCM83000-2C**  
 \* \* \* \*  
 2'8" x 8'0"  
 2'10" x 8'0"  
 3'0" x 8'0"



**FCM3000-3C**  
 \* \* \* \*  
 2'8" x 6'8"  
 2'10" x 6'8"  
 3'0" x 6'8"



**FCM83000-3C**  
 \* \* \* \*  
 2'8" x 8'0"  
 2'10" x 8'0"  
 3'0" x 8'0"



**FCM3000-4C**  
 \* \* \* \*  
 2'8" x 6'8"  
 2'10" x 6'8"  
 3'0" x 6'8"



**FCM3000F-3C**  
 \* \* \* \*  
 2'0" x 6'8" ▽  
 2'4" x 6'8" △  
 2'6" x 6'8" △ ‡  
 2'8" x 6'8" △ ‡  
 2'10" x 6'8" △ ‡  
 3'0" x 6'8" △ ‡



**FCM83000F-3C**  
 \* \* \* \*  
 2'0" x 8'0" ▽  
 2'4" x 8'0" △  
 2'6" x 8'0" △ ‡  
 2'8" x 8'0" △ ‡  
 2'10" x 8'0" △ ‡  
 3'0" x 8'0" △ ‡



**FCM3000-4C**  
 \* \* \* \*  
 2'8" x 6'8"  
 2'10" x 6'8"  
 3'0" x 6'8"



**FCM83000-4C**  
 \* \* \* \*  
 2'8" x 8'0"  
 2'10" x 8'0"  
 3'0" x 8'0"



**FCM3000F-4C**  
 \* \* \* \*  
 2'0" x 6'8" ▽  
 2'4" x 6'8" △  
 2'6" x 6'8" △ ‡  
 2'8" x 6'8" △ ‡  
 2'10" x 6'8" △ ‡  
 3'0" x 6'8" △ ‡



**FCM608**  
 \* \*  
 2'8" x 6'8"  
 2'10" x 6'8"  
 3'0" x 6'8"



**FCM6124SL**  
 \* \* \* \*  
 10" x 6'8"  
 12" x 6'8" △ ‡  
 14" x 6'8" △ ‡



**FCM6125SL**  
 \* \* \* \*  
 10" x 6'8"  
 12" x 6'8" △ ‡  
 14" x 6'8" △ ‡



**FCM6126SL**  
 \* \* \* \*  
 10" x 6'8"  
 12" x 6'8" △ ‡  
 14" x 6'8" △ ‡



**FCM81900SL**  
 \* \* \* \*  
 12" x 8'0"  
 14" x 8'0"



**FCM81947SL**  
 \* \* \* \*  
 12" x 8'0"  
 14" x 8'0"



**FCM81949SL**  
 \* \* \* \*  
 12" x 8'0"  
 14" x 8'0"



**FCM198**  
 \* \* \* \*  
 2'8" x 6'8"  
 2'10" x 6'8"  
 3'0" x 6'8"

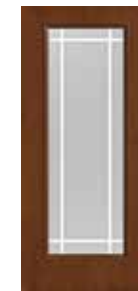

**FCM1289**  
 \* \* \* \*  
 2'4" x 6'8" △  
 2'6" x 6'8" △ ‡  
 2'8" x 6'8" △ ‡  
 2'10" x 6'8" △ ‡  
 3'0" x 6'8" △ ‡



**FCM1402**  
 \* \* \* \*  
 2'8" x 6'8"  
 2'10" x 6'8"  
 3'0" x 6'8"

Clear Glass with Divided Lites *Continues on next page.*

**Key**

- No Stile Lines
- ☀ Low-E Glass (LE)
- ▭ Simulated Divided Lites (SDL)\*,\*\*
- ◆ Flat White Grilles Between Glass Only (GBGFW)
- ◆ Flat or Contour, White or Color Grilles Between Glass (GBGF / GBGC)
- Removable Wood Grilles (RG)
- ◆ Fixed Grilles (FXG)
- Vented Sidelite (No Impact) (6'6" & 6'8" only in 12" & 14") (8'0" only in 14")
- ⚙ WBDR Options
- ⚙ WBDR / HVHZ Options
- △ 6'6" Height Available
- ‡ 7'0" Height Available
- ▭ PVC Doorlite Frame\*\*

**Optional Dentil Shelf\*\***





**Clear Glass with Divided Lites** *Continued*

|   |   |   |   |  |   |  |   |  |   |   |
|---|---|---|---|--|---|--|---|--|---|---|
|   |   |   |   |  |   |  |   |  |   |   |
| <b>FCM1408</b><br>☀️ ⬆️<br>2'8" x 6'8"<br>2'10" x 6'8"<br>3'0" x 6'8" | <b>FCM8145</b><br>☀️ ⬆️<br>2'8" x 8'0"<br>2'10" x 8'0"<br>3'0" x 8'0" | <b>FCM1405</b><br>☀️ ⬆️<br>2'8" x 6'8"<br>2'10" x 6'8"<br>3'0" x 6'8" | <b>FCM1406</b><br>☀️ ⬆️<br>2'8" x 6'8"<br>2'10" x 6'8"<br>3'0" x 6'8" | <b>FCM704</b><br>☀️ ⬆️<br>2'8" x 6'8"<br>2'10" x 6'8"<br>3'0" x 6'8" | <b>FCM8704</b><br>☀️ ⬆️<br>2'8" x 8'0"<br>2'10" x 8'0"<br>3'0" x 8'0" | <b>FCM1289SL</b><br>☀️ ⬆️ ⬇️<br>10" x 6'8"<br>12" x 6'8" ⚠️ ‡<br>14" x 6'8" ⚠️ ‡ | <b>FCM1400SL</b><br>☀️ ⬆️<br>12" x 6'8"<br>14" x 6'8" | <b>FCM81944SL</b><br>☀️ ⬆️<br>12" x 8'0"<br>14" x 8'0" | <b>FCM1405SL</b><br>☀️ ⬆️<br>12" x 8'0"<br>14" x 6'8" | <b>FCM8145SL</b><br>☀️ ⬆️<br>12" x 8'0"<br>14" x 8'0" |

**Fiber-Classic.® Oak**

|   |  |   |  |   |  |   |
|---|--|---|--|---|--|---|
|   |  |   |  |   |  |   |
| <b>FC1209</b><br>☀️ ⬆️<br>2'6" x 6'8"<br>2'8" x 6'8" ‡<br>2'10" x 6'8" ‡<br>3'0" x 6'8" ‡ | <b>FC1201</b><br>☀️ ⬆️ ⬇️<br>2'4" x 6'8" ⚠️<br>2'6" x 6'8" ⚠️ ‡<br>2'8" x 6'8" ⚠️ ‡<br>2'10" x 6'8" ⚠️ ‡<br>3'0" x 6'8" ⚠️ ‡ | <b>FC1211</b><br>☀️ ⬆️<br>2'6" x 6'8"<br>2'8" x 6'8" ‡<br>2'10" x 6'8" ‡<br>3'0" x 6'8" ‡ | <b>FC1202</b><br>☀️ ⬆️ ⬇️<br>2'4" x 6'8" ⚠️<br>2'6" x 6'8" ⚠️ ‡<br>2'8" x 6'8" ⚠️ ‡<br>2'10" x 6'8" ⚠️ ‡<br>3'0" x 6'8" ⚠️ ‡ | <b>FC1212</b><br>☀️ ⬆️<br>2'6" x 6'8"<br>2'8" x 6'8" ‡<br>2'10" x 6'8" ‡<br>3'0" x 6'8" ‡ | <b>FC1203</b><br>☀️ ⬆️ ⬇️<br>2'4" x 6'8" ⚠️<br>2'6" x 6'8" ⚠️ ‡<br>2'8" x 6'8" ⚠️ ‡<br>2'10" x 6'8" ⚠️ ‡<br>3'0" x 6'8" ⚠️ ‡ | <b>FC138</b><br>☀️ ⬆️ ⬇️<br>2'6" x 6'8"<br>2'8" x 6'8" ‡<br>2'10" x 6'8" ‡<br>3'0" x 6'8" ‡ |

\*Not recommended for use behind storm doors or to be painted dark colors, if exposed to direct sunlight.

Note: See page 273 for important product details that may help with your purchase decision.

Top: Shown Left – Smooth-Star, Clear Glass with GBGs, Doors – S808; Shown Right – Fiber-Classic Oak Collection, Clear Glass with SDLs, Door – 81946P, Sidelites 81946PSL



**1285**  
  
 2'4" x 6'8"  $\Delta$   
 2'6" x 6'8"  $\Delta$  ‡  
 2'8" x 6'8"  $\Delta$  ‡  
 2'10" x 6'8"  $\Delta$  ‡  
 3'0" x 6'8"  $\Delta$  ‡

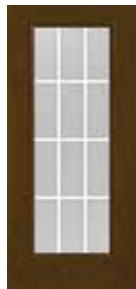

**FC1208**  
  
 2'6" x 6'8"  
 2'8" x 6'8" ‡  
 2'10" x 6'8" ‡  
 3'0" x 6'8" ‡

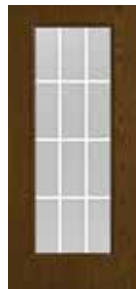

**FC1200**  
  
 2'4" x 6'8"  $\Delta$   
 2'6" x 6'8"  $\Delta$  ‡  
 2'8" x 6'8"  $\Delta$  ‡  
 2'10" x 6'8"  $\Delta$  ‡  
 3'0" x 6'8"  $\Delta$  ‡



**FC18**  
  
 2'6" x 6'8"  
 2'8" x 6'8" ‡  
 2'10" x 6'8" ‡  
 3'0" x 6'8" ‡



**1284**  
  
 2'4" x 6'8"  $\Delta$   
 2'6" x 6'8"  $\Delta$  ‡  
 2'8" x 6'8"  $\Delta$  ‡  
 2'10" x 6'8"  $\Delta$  ‡  
 3'0" x 6'8"  $\Delta$  ‡



**FC828**  
  
 2'8" x 8'0"  
 2'10" x 8'0"  
 3'0" x 8'0"



**81828**  
  
 2'4" x 6'8"  $\Delta$   
 2'6" x 6'8"  $\Delta$   
 2'8" x 6'8"  $\Delta$   
 2'10" x 6'8"  $\Delta$  ‡  
 3'0" x 6'8"  $\Delta$  ‡

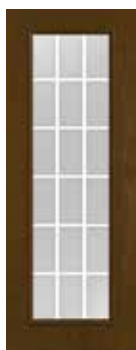

**81208P**  
  
 2'8" x 8'0"  
 2'10" x 8'0"  
 3'0" x 8'0"

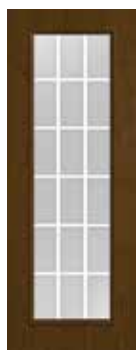

**81208**  
  
 2'6" x 8'0"  
 2'8" x 8'0"  
 2'10" x 8'0"  
 3'0" x 8'0"



**FC2106**  
  
 2'8" x 6'8"  
 2'10" x 6'8"  
 3'0" x 6'8"



**FC2107**  
  
 2'8" x 6'8"  
 2'10" x 6'8"  
 3'0" x 6'8"



**FC2108**  
  
 2'8" x 6'8"  
 2'10" x 6'8"  
 3'0" x 6'8"



**FC82**  
  
 2'8" x 6'8"  
 2'10" x 6'8"  
 3'0" x 6'8"



**FC1089**  
  
 2'8" x 6'8"  
 2'10" x 6'8"  
 3'0" x 6'8"



**FC8311**  
  
 2'8" x 8'0"  
 2'10" x 8'0"  
 3'0" x 8'0"



**FC2101**  
  
 2'8" x 6'8"  
 2'10" x 6'8"  
 3'0" x 6'8"

**FC8313**  
  
 2'8" x 8'0"  
 2'10" x 8'0"  
 3'0" x 8'0"



**FC2102**  
  
 2'8" x 6'8"  
 2'10" x 6'8"  
 3'0" x 6'8"

**FC8316**  
  
 2'8" x 8'0"  
 2'10" x 8'0"  
 3'0" x 8'0"



**FC92**  
  
 2'8" x 6'8"  
 2'10" x 6'8"  
 3'0" x 6'8"



**FC8310**  
  
 2'8" x 8'0"  
 2'10" x 8'0"  
 3'0" x 8'0"



**81945P**  
  
 2'8" x 8'0"  
 2'10" x 8'0"  
 3'0" x 8'0"

**81946P**  
  
 2'8" x 8'0"  
 2'10" x 8'0"  
 3'0" x 8'0"

Clear Glass with Divided Lites *Continues on next page.*

**Key**

No Stile Lines

Low-E Glass (LE)

Simulated Divided Lites (SDL)\*

Flat or Contour, White or Color Grilles

Between Glass (GBGF / GBGC)

Removable Wood Grilles (RG)

Fixed Grilles (FXG)

Vented Sidelite (No Impact)  
 (6'6" & 6'8" only in 12" & 14")  
 (8'0" only in 14")

WBDR / HVHZ Options

6'6" Height Available

7'0" Height Available



**Clear Glass with Divided Lites** *Continued*



**FC8322**  
 \* ♦  
 2'8" x 8'0"  
 2'10" x 8'0"  
 3'0" x 8'0"



**FC8323**  
 \* ♦ 6  
 2'8" x 8'0"  
 2'10" x 8'0"  
 3'0" x 8'0"



**FC8324**  
 \* ♦  
 2'8" x 8'0"  
 2'10" x 8'0"  
 3'0" x 8'0"



**FC63**  
 \* > ♦  
 2'6" x 6'8"  
 2'8" x 6'8" ‡  
 2'10" x 6'8" ‡  
 3'0" x 6'8" ‡



**FC65**  
 \* > ♦ > 6  
 2'6" x 6'8"  
 2'8" x 6'8" ‡  
 2'10" x 6'8" ‡  
 3'0" x 6'8" ‡



**FC8321**  
 \* > ♦ 6  
 2'8" x 8'0"  
 2'10" x 8'0"  
 3'0" x 8'0"



**FC8318**  
 \* ♦  
 2'8" x 8'0"  
 2'10" x 8'0"  
 3'0" x 8'0"



**FC8319**  
 \* > ♦ 6  
 2'8" x 8'0"  
 2'10" x 8'0"  
 3'0" x 8'0"



**FC8320**  
 \* > ♦  
 2'8" x 8'0"  
 2'10" x 8'0"  
 3'0" x 8'0"



**FC832**  
 \* > ♦ > 6  
 2'8" x 8'0"  
 2'10" x 8'0"  
 3'0" x 8'0"



**FC807**  
 \* > ♦ >  
 2'8" x 6'8"  
 2'10" x 6'8"  
 3'0" x 6'8"



**FC809203**  
 \* > ♦ > 6  
 2'8" x 6'8"  
 2'10" x 6'8"  
 3'0" x 6'8"



**FC862203**  
 \* > ♦ > 6  
 2'8" x 8'0"  
 2'10" x 8'0"  
 3'0" x 8'0"



**FC752**  
 \* > ♦ > 6  
 2'8" x 6'8" ‡  
 2'10" x 6'8" ‡  
 3'0" x 6'8" ‡

**FC8752**  
 \* > ♦  
 2'8" x 8'0"  
 2'10" x 8'0"  
 3'0" x 8'0"



**FC23**  
 \* > ♦  
 2'6" x 6'8"  
 2'8" x 6'8"  
 2'10" x 6'8"  
 3'0" x 6'8"



**FC1209SL**  
 \* > ♦  
 10" x 6'8"  
 12" x 6'8"  
 14" x 6'8"



**FC1201SL**  
 \* > ♦ > 6  
 12" x 6'8" ‡  
 14" x 6'8" ‡



**FC1211SL**  
 \* > ♦  
 10" x 6'8"  
 12" x 6'8"  
 14" x 6'8"



**FC1202SL**  
 \* > ♦ > 6  
 12" x 6'8" ‡  
 14" x 6'8" ‡



**FC1208SL**  
 \* > ♦ 6  
 10" x 6'8"  
 12" x 6'8"  
 14" x 6'8"



**FC1200SL**  
 \* > ♦ > 6  
 12" x 6'8" ‡  
 14" x 6'8" ‡



**FC18SL**  
 \* > ♦ > 6  
 10" x 6'8"  
 12" x 6'8"  
 14" x 6'8"



**12102SL**  
 \* > ♦ > 6  
 12" x 6'8" ‡  
 14" x 6'8" ‡

\*2'0" frames do not have simulated divided lites option.

\*\*Not recommended for use behind storm doors or to be painted dark colors, if exposed to direct sunlight.

Note: See page 273 for important product details that may help with your purchase decision.



|   |  |  |  |   |  |   |   |   |  |   |   |   |
|---|--|--|--|---|--|---|---|---|--|---|---|---|
| <b>81208PSL</b><br>☀️👉👈<br>12"x 8'0"<br>14"x 8'0" | <b>81208SL</b><br>☀️👉👈👉👈<br>12"x 8'0"<br>14"x 8'0" | <b>FC1089SL</b><br>☀️👉<br>12"x 6'8"<br>14"x 6'8" | <b>FC8311SL</b><br>☀️👉<br>12"x 8'0"<br>14"x 8'0" | <b>FC2101SL</b><br>☀️👉👈<br>12"x 6'8"<br>14"x 6'8" | <b>FC8313SL</b><br>☀️👉<br>12"x 8'0"<br>14"x 8'0" | <b>FC92SL</b><br>☀️👉👈<br>12"x 6'8"<br>14"x 6'8" | <b>FC8310SL</b><br>☀️👉👈<br>12"x 8'0"<br>14"x 8'0" | <b>81946PSL</b><br>☀️👉👈👉👈<br>12"x 8'0"<br>14"x 8'0" | <b>FC8675SL</b><br>☀️👉<br>12"x 8'0"<br>14"x 8'0" | <b>FC63SL</b><br>☀️👉👈👉👈<br>12"x 6'8"<br>14"x 6'8" | <b>FC7125SL</b><br>☀️👉👈<br>12"x 8'0"<br>14"x 8'0" | <b>FC3487SL</b><br>☀️👉👈<br>12"x 8'0"<br>14"x 8'0" |
|---|--|--|--|---|--|---|---|---|--|---|---|---|



|   |  |   |  |   |  |   |  |   |  |
|---|--|---|--|---|--|---|--|---|--|
| <b>FC3000-2C</b><br>☀️👉👈<br>2'6"x 6'8"<br>2'8"x 6'8" ‡<br>2'10"x 6'8" ‡<br>3'0"x 6'8" ‡ | <b>FC083000P-2C</b><br>☀️👉👈<br>2'8"x 8'0"<br>2'10"x 8'0"<br>3'0"x 8'0" | <b>FC03000F-2C</b><br>☀️👉👈<br>2'0"x 6'8" ▴<br>2'4"x 6'8" ▴<br>2'6"x 6'8" ▴‡<br>2'8"x 6'8" ▴‡<br>2'10"x 6'8" ▴‡<br>3'0"x 6'8" ▴‡ | <b>FC083000F-2C</b><br>☀️👉👈<br>2'0"x 8'0" ▽<br>2'4"x 8'0" ▽<br>2'6"x 8'0"<br>2'8"x 8'0"<br>2'10"x 8'0"<br>3'0"x 8'0" | <b>FC3000-3C</b><br>☀️👉👈<br>2'6"x 6'8"<br>2'8"x 6'8" ‡<br>2'10"x 6'8" ‡<br>3'0"x 6'8" ‡ | <b>FC083000P-3C</b><br>☀️👉👈<br>2'8"x 8'0"<br>2'10"x 8'0"<br>3'0"x 8'0" | <b>FC03000F-3C</b><br>☀️👉👈<br>2'0"x 6'8" ▽<br>2'4"x 6'8" ▴<br>2'6"x 6'8" ▴‡<br>2'8"x 6'8" ▴‡<br>2'10"x 6'8" ▴‡<br>3'0"x 6'8" ▴‡ | <b>FC083000F-3C</b><br>☀️👉👈<br>2'0"x 8'0" ▽<br>2'4"x 8'0" ▽<br>2'6"x 8'0"<br>2'8"x 8'0"<br>2'10"x 8'0"<br>3'0"x 8'0" | <b>FC3000-4C</b><br>☀️👉👈<br>2'6"x 6'8"<br>2'8"x 6'8" ‡<br>2'10"x 6'8" ‡<br>3'0"x 6'8" ‡ | <b>FC083000P-4C</b><br>☀️👉👈<br>2'8"x 8'0"<br>2'10"x 8'0"<br>3'0"x 8'0" |
|---|--|---|--|---|--|---|--|---|--|



|   |  |   |  |   |  |   |   |   |
|---|--|---|--|---|--|---|---|---|
| <b>FC03000F-4C</b><br>☀️👉👈<br>2'0"x 6'8" ▽<br>2'4"x 6'8" ▴<br>2'6"x 6'8" ▴‡<br>2'8"x 6'8" ▴‡<br>2'10"x 6'8" ▴‡<br>3'0"x 6'8" ▴‡ | <b>FC083000F-4C</b><br>☀️👉👈<br>2'0"x 8'0" ▽<br>2'4"x 8'0" ▽<br>2'6"x 8'0"<br>2'8"x 8'0"<br>2'10"x 8'0"<br>3'0"x 8'0" | <b>FC3000-6C</b><br>☀️👉👈<br>2'6"x 6'8"<br>2'8"x 6'8" ‡<br>2'10"x 6'8" ‡<br>3'0"x 6'8" ‡ | <b>FC083000P-6C</b><br>☀️👉👈<br>2'8"x 8'0"<br>2'10"x 8'0"<br>3'0"x 8'0" | <b>FC03000F-6C</b><br>☀️👉👈<br>2'0"x 6'8" ▽<br>2'4"x 6'8" ▴<br>2'6"x 6'8" ▴‡<br>2'8"x 6'8" ▴‡<br>2'10"x 6'8" ▴‡<br>3'0"x 6'8" ▴‡ | <b>FC083000F-6C</b><br>☀️👉👈<br>2'0"x 8'0" ▽<br>2'4"x 8'0" ▽<br>2'6"x 8'0"<br>2'8"x 8'0"<br>2'10"x 8'0"<br>3'0"x 8'0" | <b>81947P</b><br>☀️👉<br>2'8"x 8'0"<br>2'10"x 8'0"<br>3'0"x 8'0" | <b>81948P</b><br>☀️👉<br>2'8"x 8'0"<br>2'10"x 8'0"<br>3'0"x 8'0" | <b>81949P</b><br>☀️👉<br>2'8"x 8'0"<br>2'10"x 8'0"<br>3'0"x 8'0" |
|---|--|---|--|---|--|---|---|---|

Clear Glass with Divided Lites *Continues on next page.*

**Key**

- ☐ No Stile Lines
- ☀️ Low-E Glass (LE)
- 👉 Simulated Divided Lites (SDL)\*, \*\*
- ◆ Flat White Grilles Between Glass Only (GBGFW)
- 👈 Flat or Contour, White or Color Grilles Between Glass (GBGF / GBGC)
- 👉 Removable Wood Grilles (RG)
- 👈 Fixed Grilles (FXG)
- 👈 Vented Sidelite (No Impact) (6'6" & 6'8" only in 12" & 14") (8'0" only in 14")
- 👈 WBDR Options
- 👈 WBDR / HVHZ Options
- ▴ 6'6" Height Available
- ‡ 7'0" Height Available
- ▽ PVC Doorlite Frame\*\*

**Clear Glass with Divided Lites** *Continued*



**81950P**  
  
 2'8" x 8'0"  
 2'10" x 8'0"  
 3'0" x 8'0"



**FC06188SL**  
  
 10" x 6'8"  
 12" x 6'8"  
 14" x 6'8"



**FC06184SL**  
  
 12" x 6'8"  $\Delta$  ‡  
 14" x 6'8"  $\Delta$  ‡



**FC06189SL**  
  
 10" x 6'8"  
 12" x 6'8"  
 14" x 6'8"



**FC06185SL**  
  
 12" x 6'8"  $\Delta$  ‡  
 14" x 6'8"  $\Delta$  ‡



**FC06190SL**  
  
 10" x 6'8"  
 12" x 6'8"  
 14" x 6'8"



**FC06186SL**  
  
 12" x 6'8"  $\Delta$  ‡  
 14" x 6'8"  $\Delta$  ‡



**81900PSL**  
  
 12" x 8'0"  
 14" x 8'0"



**81947PSL**  
  
 12" x 8'0"  
 14" x 8'0"



**81949PSL**  
  
 12" x 8'0"  
 14" x 8'0"

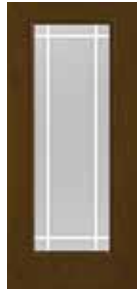

**FC198**  
  
 2'6" x 6'8"  
 2'8" x 6'8" ‡  
 2'10" x 6'8" ‡  
 3'0" x 6'8" ‡

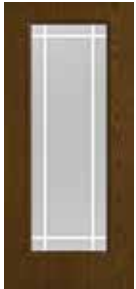

**1289**  
  
 2'4" x 6'8"  $\Delta$   
 2'6" x 6'8"  $\Delta$  ‡  
 2'8" x 6'8"  $\Delta$  ‡  
 2'10" x 6'8"  $\Delta$  ‡  
 3'0" x 6'8"  $\Delta$  ‡



**FC1402**  
  
 2'8" x 6'8"  
 2'10" x 6'8"  
 3'0" x 6'8"



**FC1400**  
  
 2'8" x 6'8"  
 2'10" x 6'8"  
 3'0" x 6'8"



**81944P**  
  
 2'8" x 8'0"  
 2'10" x 8'0"  
 3'0" x 8'0"



**FC1408**  
  
 2'6" x 6'8"  
 2'8" x 6'8" ‡  
 2'10" x 6'8" ‡  
 3'0" x 6'8" ‡



**FC8145**  
  
 2'8" x 8'0"  
 2'10" x 8'0"  
 3'0" x 8'0"



**FC8144**  
  
 2'8" x 8'0"  
 2'10" x 8'0"  
 3'0" x 8'0"



**FC1411**  
  
 2'8" x 6'8"  
 2'10" x 6'8"  
 3'0" x 6'8"



**FC1404**  
  
 2'8" x 6'8"  
 2'10" x 6'8"  
 3'0" x 6'8"



**FC8141**  
  
 2'8" x 8'0"  
 2'10" x 8'0"  
 3'0" x 8'0"



**FC704**  
  
 2'8" x 6'8" ‡  
 2'10" x 6'8" ‡  
 3'0" x 6'8" ‡



**FC8704**  
  
 2'8" x 8'0"  
 2'10" x 8'0"  
 3'0" x 8'0"



**FC198SL**  
  
 10" x 6'8"  
 12" x 6'8"  
 14" x 6'8"



**FC1289SL**  
  
 12" x 6'8"  $\Delta$  ‡  
 14" x 6'8"  $\Delta$  ‡

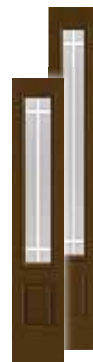

**FC1400SL** | **81944PSL**  
  
 12" x 6'8"  
 14" x 6'8"



**FC1408SL** | **FC8145SL**  
  
 12" x 6'8"  
 14" x 6'8"

\*Not recommended for use behind storm doors or to be painted dark colors, if exposed to direct sunlight.  
 Note: See page 273 for important product details that may help with your purchase decision.



# Smooth-Star®



**S1209**  
 \*♦  
 2'6" x 6'8" ⚠  
 2'8" x 6'8" ⚠‡  
 2'10" x 6'8" ⚠‡  
 3'0" x 6'8" ⚠‡



**S1201**  
 \*♦♦♦  
 2'4" x 6'8" ⚠  
 2'6" x 6'8" ⚠  
 2'8" x 6'8" ⚠‡  
 2'10" x 6'8" ⚠‡  
 3'0" x 6'8" ⚠‡  
 3'6" x 6'8"



**S1211**  
 \*♦♦♦  
 2'6" x 6'8" ⚠  
 2'8" x 6'8" ⚠‡  
 2'10" x 6'8" ⚠‡  
 3'0" x 6'8" ⚠‡



**S1202**  
 \*♦♦♦  
 2'4" x 6'8" ⚠  
 2'6" x 6'8" ⚠  
 2'8" x 6'8" ⚠‡  
 2'10" x 6'8" ⚠‡  
 3'0" x 6'8" ⚠‡  
 3'6" x 6'8"



**S1212**  
 \*♦♦♦  
 2'6" x 6'8" ⚠  
 2'8" x 6'8" ⚠‡  
 2'10" x 6'8" ⚠‡  
 3'0" x 6'8" ⚠‡



**S1203**  
 \*♦♦♦  
 2'4" x 6'8" ⚠  
 2'6" x 6'8" ⚠  
 2'8" x 6'8" ⚠‡  
 2'10" x 6'8" ⚠‡  
 3'0" x 6'8" ⚠‡  
 3'6" x 6'8"



**S128**  
 \*♦♦♦♦♦♦  
 2'6" x 6'8" ⚠  
 2'8" x 6'8" ⚠‡  
 2'10" x 6'8" ⚠‡  
 3'0" x 6'8" ⚠‡



**S141**  
 \*♦♦♦♦♦♦♦♦  
 2'4" x 6'8" ⚠  
 2'6" x 6'8" ⚠  
 2'8" x 6'8" ⚠‡  
 2'10" x 6'8" ⚠‡  
 3'0" x 6'8" ⚠‡  
 3'6" x 6'8"



**S1208**  
 \*♦♦♦♦♦  
 2'6" x 6'8" ⚠  
 2'8" x 6'8" ⚠‡  
 2'10" x 6'8" ⚠‡  
 3'0" x 6'8" ⚠‡



**S1200**  
 \*♦♦♦♦♦♦  
 2'4" x 6'8" ⚠  
 2'6" x 6'8" ⚠  
 2'8" x 6'8" ⚠‡  
 2'10" x 6'8" ⚠‡  
 3'0" x 6'8" ⚠‡  
 3'6" x 6'8"



**S108**  
 \*♦♦♦♦♦♦♦♦  
 2'6" x 6'8" ⚠  
 2'8" x 6'8" ⚠‡  
 2'10" x 6'8" ⚠‡  
 3'0" x 6'8" ⚠‡



**S6063**  
 \*♦♦♦♦♦♦♦♦  
 2'4" x 6'8" ⚠  
 2'6" x 6'8" ⚠  
 2'8" x 6'8" ⚠‡  
 2'10" x 6'8" ⚠‡  
 3'0" x 6'8" ⚠‡  
 3'6" x 6'8"



**S828**  
 \*♦♦♦♦♦  
 2'6" x 8'0"  
 2'8" x 8'0"  
 2'10" x 8'0"  
 3'0" x 8'0"



**S81828**  
 \*♦♦♦♦♦♦♦♦  
 2'6" x 8'0"  
 2'8" x 8'0"  
 2'10" x 8'0"  
 3'0" x 8'0"  
 3'6" x 8'0"



**S808**  
 \*♦♦♦♦♦  
 2'6" x 8'0"  
 2'8" x 8'0"  
 2'10" x 8'0"  
 3'0" x 8'0"



**S81208**  
 \*♦♦♦♦♦♦♦♦  
 2'6" x 8'0"  
 2'8" x 8'0"  
 2'10" x 8'0"  
 3'0" x 8'0"  
 3'6" x 8'0"



**S2106**  
 \*♦♦  
 2'8" x 6'8"  
 2'10" x 6'8"  
 3'0" x 6'8"



**S2107**  
 \*♦♦♦  
 2'8" x 6'8"  
 2'10" x 6'8"  
 3'0" x 6'8"



**S2108**  
 \*♦♦♦  
 2'8" x 6'8"  
 2'10" x 6'8"  
 3'0" x 6'8"



**S82**  
 \*♦♦♦♦♦♦♦♦  
 2'8" x 6'8"  
 2'10" x 6'8"  
 3'0" x 6'8"



**S1089**  
 \*♦♦♦  
 2'8" x 6'8"  
 2'10" x 6'8"  
 3'0" x 6'8"



**S8311**  
 \*♦♦♦  
 2'8" x 8'0"  
 2'10" x 8'0"  
 3'0" x 8'0"



**S2101**  
 \*♦♦♦♦♦  
 2'8" x 6'8"  
 2'10" x 6'8"  
 3'0" x 6'8"

**S8313**  
 \*♦♦♦  
 2'8" x 8'0"  
 2'10" x 8'0"  
 3'0" x 8'0"

## Key

- No Stile Lines
- ☀ Low-E Glass (LE)
- Simulated Divided Lites (SDL)\*
- ◆ Flat White Grilles Between Glass Only (GBGFW)
- ◆ Flat or Contour, White or Color Grilles Between Glass (GBGF / GBGC)
- ▶ Removable Wood Grilles (RG)
- ◆ Fixed Grilles (FXG)
- Vented Sidelite (No Impact) (6'6" & 6'8" only in 12" & 14") (8'0" only in 14")
- ⚠ 6'6" Height Available
- ‡ 7'0" Height Available
- 6 WBDR Options
- 6 WBDR / HVHZ Options

Clear Glass with Divided Lites *Continues on next page.*



**Clear Glass with Divided Lites** *Continued*

|   |   |   |   |   |  |   |  |
|---|---|---|---|---|--|---|--|
|       |  |   |   |  |  |  |   |
| S881<br>* > > > > 6<br>2'8" x 8'0"<br>2'10" x 8'0"<br>3'0" x 8'0"                       | S92<br>* > > > > 6<br>2'8" x 6'8"<br>2'10" x 6'8"<br>3'0" x 6'8"                    | S8310<br>* > > 6<br>2'8" x 8'0"<br>2'10" x 8'0"<br>3'0" x 8'0"                      | S882<br>* > > > > 6<br>2'8" x 8'0"<br>2'10" x 8'0"<br>3'0" x 8'0"                   | S663<br>* ><br>2'8" x 6'8" ‡<br>2'10" x 6'8" ‡<br>3'0" x 6'8" ‡                     | S6097<br>* ><br>2'8" x 6'8" ‡<br>2'10" x 6'8" ‡<br>3'0" x 6'8" ‡                     | S811<br>* ><br>2'8" x 6'8"<br>2'10" x 6'8"<br>3'0" x 6'8"                             | S262<br>* > > > > 6<br>2'6" x 6'8"<br>2'8" x 6'8" ‡<br>2'10" x 6'8" ‡<br>3'0" x 6'8" ‡ |
|      |  |  |  |  |  |  |   |
| S6022<br>* > > > > 6<br>2'6" x 6'8"<br>2'8" x 6'8" ‡<br>2'10" x 6'8" ‡<br>3'0" x 6'8" ‡ | S6042<br>* > > > > 6<br>2'8" x 6'8"<br>2'10" x 6'8"<br>3'0" x 6'8"                  | S8322<br>* > ><br>2'8" x 8'0"<br>2'10" x 8'0"<br>3'0" x 8'0"                        | S8323<br>* > > > 6<br>2'8" x 8'0"<br>2'10" x 8'0"<br>3'0" x 8'0"                    | S8324<br>* > ><br>2'8" x 8'0"<br>2'10" x 8'0"<br>3'0" x 8'0"                        | S8321<br>* > > > > 6<br>2'8" x 8'0"<br>2'10" x 8'0"<br>3'0" x 8'0"                   | S8318<br>* > ><br>2'8" x 8'0"<br>2'10" x 8'0"<br>3'0" x 8'0"                          | S8319<br>* > > > 6<br>2'8" x 8'0"<br>2'10" x 8'0"<br>3'0" x 8'0"                       |

\*Not recommended for use behind storm doors or to be painted dark colors, if exposed to direct sunlight.  
 Note: See page 273 for important product details that may help with your purchase decision.  
 Top: Smooth-Star, Clear Glass with GBGs, Door – S1089, Transom – 19200T



**S8320**  
  
 2'8" x 8'0"  
 2'10" x 8'0"  
 3'0" x 8'0"

**S32**  
  
 2'8" x 6'8"  
 2'10" x 6'8"  
 3'0" x 6'8"

**S832**  
  
 2'8" x 8'0"  
 2'10" x 8'0"  
 3'0" x 8'0"

**S151**  
  
 2'8" x 6'8"  
 2'10" x 6'8"  
 3'0" x 6'8"

**S807**  
  
 2'8" x 6'8"  
 2'10" x 6'8"  
 3'0" x 6'8"

**S93203**  
  
 2'8" x 6'8"  
 2'10" x 6'8"  
 3'0" x 6'8"

**S831203**  
  
 2'8" x 8'0"  
 2'10" x 8'0"  
 3'0" x 8'0"

**S115**  
  
 2'6" x 6'8"  
 2'8" x 6'8" ‡  
 2'10" x 6'8" ‡  
 3'0" x 6'8" ‡

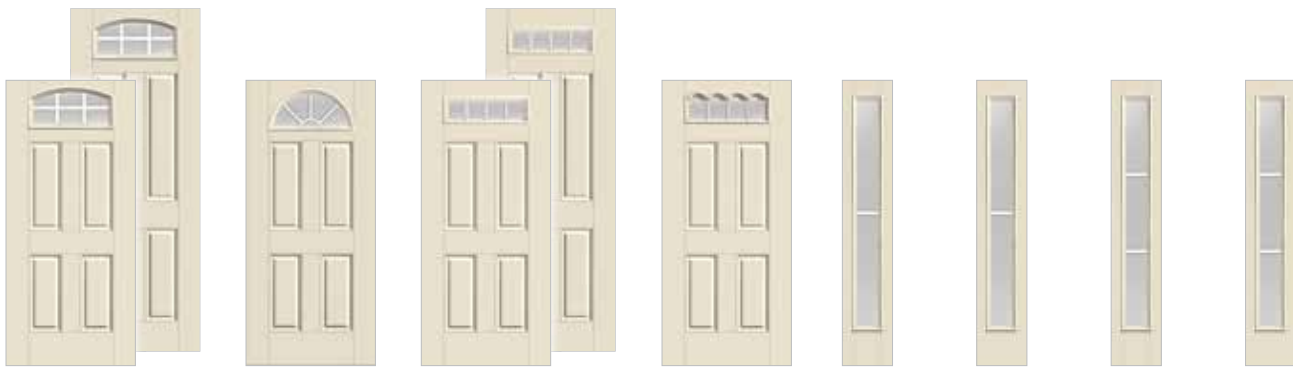

**S752**  
  
 2'8" x 6'8" ‡  
 2'10" x 6'8" ‡  
 3'0" x 6'8" ‡

**S8752**  
  
 2'8" x 8'0"  
 2'10" x 8'0"  
 3'0" x 8'0"

**S255**  
  
 2'8" x 6'8"  
 2'10" x 6'8"  
 3'0" x 6'8"

**S236**  
  
 2'6" x 6'8"  
 2'8" x 6'8"  
 2'10" x 6'8"  
 3'0" x 6'8"

**S8317**  
  
 2'6" x 8'0"  
 2'8" x 8'0"  
 2'10" x 8'0"  
 3'0" x 8'0"

**S237**  
  
 2'8" x 6'8"  
 2'10" x 6'8"  
 3'0" x 6'8"  
 (Scalloped Lite Frame)

**S1209SL**  
  
 12" x 6'8"  
 14" x 6'8"

**S1201SL**  
  
 10" x 6'8"  
 12" x 6'8" ‡  
 14" x 6'8" ‡

**S1211SL**  
  
 12" x 6'8"  
 14" x 6'8"

**S1202SL**  
  
 10" x 6'8"  
 12" x 6'8" ‡  
 14" x 6'8" ‡



**S1208SL**  
  
 12" x 6'8"  
 14" x 6'8"

**S1200SL**  
  
 10" x 6'8"  
 12" x 6'8" ‡  
 14" x 6'8" ‡

**S308SL**  
  
 12" x 6'8"  
 14" x 6'8"

**S1170SL**  
  
 10" x 6'8"  
 12" x 6'8" ‡  
 14" x 6'8" ‡

**S808SL**  
  
 12" x 8'0"  
 14" x 8'0"

**S81186SL**  
  
 12" x 8'0"  
 14" x 8'0"

**S1089SL**  
  
 12" x 6'8"  
 14" x 6'8"

**S8311SL**  
  
 12" x 8'0"  
 14" x 8'0"

**S2101SL**  
  
 12" x 6'8"  
 14" x 6'8"

**S8313SL**  
  
 12" x 8'0"  
 14" x 8'0"

**S8310SL**  
  
 12" x 8'0"  
 14" x 8'0"

**S82SL**  
  
 12" x 6'8"  
 14" x 6'8"

































Clear Glass with Divided Lites *Continues on next page.*

**Key**

- No Stile Lines
- Low-E Glass (LE)
- Simulated Divided Lites (SDL)\*
- Flat or Contour, White or Color Grilles Between Glass (GBGF / GBGC)
- Removable Wood Grilles (RG)
- Fixed Grilles (FXG)
- Vented Sidelite (No Impact)  
 (6'6" & 6'8" only in 12" & 14")  
 (8'0" only in 14")
- WBDR Options
- WBDR / HVHZ Options
- 6'6" Height Available
- 7'0" Height Available



## Clear Glass with Divided Lites *Continued*

|   |  |   |  |   |  |   |  |   |  |   |  |
|---|--|---|--|---|--|---|--|---|--|---|--|
|    |   |                    |       |    |   |                    |      |   |   |                  |     |
| <b>S881SL</b><br>◆ ◆ ◆<br>12" x 8'0"<br>14" x 8'0"  | <b>S8675SL</b><br>◆ ◆ ◆<br>12" x 8'0"<br>14" x 8'0"  | <b>S263SL</b><br>◆ ◆ ◆<br>12" x 6'8"<br>14" x 6'8"  | <b>S7125SL</b><br>◆ ◆ ◆<br>12" x 8'0"<br>14" x 8'0"                                    | <b>S3487SL</b><br>◆ ◆ ◆<br>12" x 8'0"<br>14" x 8'0"   | <b>S151SL</b><br>◆ ◆ ◆<br>12" x 6'8"<br>14" x 6'8"   | <b>S3000-2C</b><br>◆ ◆ ◆<br>2'6" x 6'8" △<br>2'8" x 6'8" △ †<br>2'10" x 6'8" △ †<br>3'0" x 6'8" △ † | <b>S83000-2C</b><br>◆ ◆ ◆<br>2'6" x 8'0"<br>2'8" x 8'0"<br>2'10" x 8'0"<br>3'0" x 8'0" | <b>S3000F-2C</b><br>◆ ◆ ◆<br>2'0" x 6'8" △<br>2'4" x 6'8" △<br>2'6" x 6'8" △<br>2'8" x 6'8" △ †<br>2'10" x 6'8" △ †<br>3'0" x 6'8" △ †<br>3'6" x 6'8" | <b>S83000F-2C</b><br>◆ ◆ ◆<br>2'0" x 8'0" △<br>2'4" x 8'0" △<br>2'6" x 8'0"<br>2'8" x 8'0"<br>2'10" x 8'0"<br>3'0" x 8'0"<br>3'6" x 8'0" | <b>S3000-3C</b><br>◆ ◆ ◆<br>2'6" x 6'8" △<br>2'8" x 6'8" △ †<br>2'10" x 6'8" △ †<br>3'0" x 6'8" △ † | <b>S83000-3C</b><br>◆ ◆ ◆<br>2'6" x 8'0"<br>2'8" x 8'0"<br>2'10" x 8'0"<br>3'0" x 8'0" |
|   |    |                   |      |    |   |                 |    |   |    |   |  |
| <b>S3000F-3C</b><br>◆ ◆ ◆<br>2'0" x 6'8" △<br>2'4" x 6'8" △<br>2'6" x 6'8" △<br>2'8" x 6'8" △ †<br>2'10" x 6'8" △ †<br>3'0" x 6'8" △ †<br>3'6" x 6'8" | <b>S83000F-3C</b><br>◆ ◆ ◆<br>2'0" x 8'0" △<br>2'4" x 8'0" △<br>2'6" x 8'0"<br>2'8" x 8'0"<br>2'10" x 8'0"<br>3'0" x 8'0"<br>3'6" x 8'0" | <b>S3000-4C</b><br>◆ ◆ ◆<br>2'6" x 6'8" △<br>2'8" x 6'8" △ †<br>2'10" x 6'8" △ †<br>3'0" x 6'8" △ † | <b>S83000-4C</b><br>◆ ◆ ◆<br>2'6" x 8'0"<br>2'8" x 8'0"<br>2'10" x 8'0"<br>3'0" x 8'0" | <b>S3000F-4C</b><br>◆ ◆ ◆<br>2'0" x 6'8" △<br>2'4" x 6'8" △<br>2'6" x 6'8" △<br>2'8" x 6'8" △ †<br>2'10" x 6'8" △ †<br>3'0" x 6'8" △ †<br>3'6" x 6'8" | <b>S83000F-4C</b><br>◆ ◆ ◆<br>2'0" x 8'0" △<br>2'4" x 8'0" △<br>2'6" x 8'0"<br>2'8" x 8'0"<br>2'10" x 8'0"<br>3'0" x 8'0"<br>3'6" x 8'0" | <b>S3000-6C</b><br>◆ ◆ ◆<br>2'6" x 6'8" △<br>2'8" x 6'8" △ †<br>2'10" x 6'8" △ †<br>3'0" x 6'8" △ † | <b>S83000-6C</b><br>◆ ◆ ◆<br>2'6" x 8'0"<br>2'8" x 8'0"<br>2'10" x 8'0"<br>3'0" x 8'0" | <b>S3000F-6C</b><br>◆ ◆ ◆<br>2'0" x 6'8" △<br>2'4" x 6'8" △<br>2'6" x 6'8" △<br>2'8" x 6'8" △ †<br>2'10" x 6'8" △ †<br>3'0" x 6'8" △ †<br>3'6" x 6'8" | <b>S83000F-6C</b><br>◆ ◆ ◆<br>2'0" x 8'0" △<br>2'4" x 8'0" △<br>2'6" x 8'0"<br>2'8" x 8'0"<br>2'10" x 8'0"<br>3'0" x 8'0"<br>3'6" x 8'0" |   |  |
|    |   |                  |     |    |    |                 |   |    |   |   |  |
| <b>S8202</b><br>◆ ◆ ◆<br>2'8" x 8'0"<br>2'10" x 8'0"<br>3'0" x 8'0"   | <b>S8203</b><br>◆ ◆ ◆<br>2'8" x 8'0"<br>2'10" x 8'0"<br>3'0" x 8'0"  | <b>S8204</b><br>◆ ◆ ◆<br>2'8" x 8'0"<br>2'10" x 8'0"<br>3'0" x 8'0"                                 | <b>S8205</b><br>◆ ◆ ◆<br>2'8" x 8'0"<br>2'10" x 8'0"<br>3'0" x 8'0"                    | <b>S605</b><br>◆ ◆ ◆<br>2'8" x 6'8"<br>2'10" x 6'8"<br>3'0" x 6'8"  | <b>S8605</b><br>◆ ◆ ◆<br>2'8" x 8'0"<br>2'10" x 8'0"<br>3'0" x 8'0"  | <b>S606</b><br>◆ ◆ ◆<br>2'8" x 6'8"<br>2'10" x 6'8"<br>3'0" x 6'8"                                  | <b>S8606</b><br>◆ ◆ ◆<br>2'8" x 8'0"<br>2'10" x 8'0"<br>3'0" x 8'0"                    | <b>S607</b><br>◆ ◆ ◆<br>2'8" x 6'8"<br>2'10" x 6'8"<br>3'0" x 6'8"  | <b>S8607</b><br>◆ ◆ ◆<br>2'8" x 8'0"<br>2'10" x 8'0"<br>3'0" x 8'0"  |   |  |

\*2'0" frames do not have simulated divided lites option.

\*\*Not recommended for use behind storm doors or to be painted dark colors, if exposed to direct sunlight.

Note: See page 273 for important product details that may help with your purchase decision.



|  |   |  |   |   |  |  |   |   |  |  |   |   |  |
|--|---|--|---|---|--|--|---|---|--|--|---|---|--|
| <b>S608</b><br>★<br>2'8" x 6'8"<br>2'10" x 6'8"<br>3'0" x 6'8" | <b>S8608</b><br>★<br>2'8" x 8'0"<br>2'10" x 8'0"<br>3'0" x 8'0" | <b>S605SL</b><br>★<br>12" x 6'8"<br>14" x 6'8" | <b>S8605SL</b><br>★<br>12" x 8'0"<br>14" x 8'0" | <b>S6124SL</b><br>★<br>10" x 6'8"<br>12" x 6'8" † ‡<br>14" x 6'8" † ‡ | <b>S85924SL</b><br>★<br>12" x 8'0"<br>14" x 8'0" | <b>S606SL</b><br>★<br>12" x 6'8"<br>14" x 6'8" | <b>S8606SL</b><br>★<br>12" x 8'0"<br>14" x 8'0" | <b>S6125SL</b><br>★<br>10" x 6'8"<br>12" x 6'8" † ‡<br>14" x 6'8" † ‡ | <b>S85925SL</b><br>★<br>12" x 8'0"<br>14" x 8'0" | <b>S607SL</b><br>★<br>12" x 6'8"<br>14" x 6'8" | <b>S8607SL</b><br>★<br>12" x 8'0"<br>14" x 8'0" | <b>S6126SL</b><br>★<br>10" x 6'8"<br>12" x 6'8" † ‡<br>14" x 6'8" † ‡ | <b>S85926SL</b><br>★<br>12" x 8'0"<br>14" x 8'0" |
|--|---|--|---|---|--|--|---|---|--|--|---|---|--|



|   |   |   |   |  |   |   |  |  |   |
|---|---|---|---|--|---|---|--|--|---|
| <b>S8207SL</b><br>★<br>12" x 8'0"<br>14" x 8'0" | <b>S8202SL</b><br>★<br>12" x 8'0"<br>14" x 8'0" | <b>S8204SL</b><br>★<br>12" x 8'0"<br>14" x 8'0" | <b>S198</b><br>★<br>2'6" x 6'8" †<br>2'8" x 6'8" † ‡<br>2'10" x 6'8" † ‡<br>3'0" x 6'8" † ‡ | <b>S6062</b><br>★<br>2'4" x 6'8" †<br>2'6" x 6'8" †<br>2'8" x 6'8" † ‡<br>2'10" x 6'8" † ‡<br>3'0" x 6'8" † ‡<br>3'6" x 6'8" | <b>S1402</b><br>★<br>2'8" x 6'8"<br>2'10" x 6'8"<br>3'0" x 6'8" | <b>S1400</b><br>★<br>2'8" x 6'8"<br>2'10" x 6'8"<br>3'0" x 6'8" | <b>S898</b><br>★<br>2'8" x 8'0"<br>2'10" x 8'0"<br>3'0" x 8'0" | <b>S1408</b><br>★<br>2'6" x 6'8"<br>2'8" x 6'8" †<br>2'10" x 6'8" †<br>3'0" x 6'8" † | <b>S8145</b><br>★<br>2'8" x 8'0"<br>2'10" x 8'0"<br>3'0" x 8'0" |
|---|---|---|---|--|---|---|--|--|---|



|  |   |   |   |   |   |   |  |   |
|--|---|---|---|---|---|---|--|---|
| <b>S1405</b><br>★<br>2'6" x 6'8"<br>2'8" x 6'8" †<br>2'10" x 6'8" †<br>3'0" x 6'8" † | <b>S1406</b><br>★<br>2'8" x 6'8"<br>2'10" x 6'8"<br>3'0" x 6'8" | <b>S1407</b><br>★<br>2'8" x 6'8"<br>2'10" x 6'8"<br>3'0" x 6'8" | <b>S8144</b><br>★<br>2'8" x 8'0"<br>2'10" x 8'0"<br>3'0" x 8'0" | <b>S1411</b><br>★<br>2'8" x 6'8"<br>2'10" x 6'8"<br>3'0" x 6'8" | <b>S1404</b><br>★<br>2'8" x 6'8"<br>2'10" x 6'8"<br>3'0" x 6'8" | <b>S8141</b><br>★<br>2'8" x 8'0"<br>2'10" x 8'0"<br>3'0" x 8'0" | <b>S704</b><br>★<br>2'8" x 6'8" †<br>2'10" x 6'8" †<br>3'0" x 6'8" † | <b>S8704</b><br>★<br>2'8" x 8'0"<br>2'10" x 8'0"<br>3'0" x 8'0" |
|--|---|---|---|---|---|---|--|---|

Clear Glass with Divided Lites *Continues on next page.*

**Key**

- No Stile Lines
- ★ Low-E Glass (LE)
- 🏠 Simulated Divided Lites (SDL)\*, \*\*
- ◆ Flat White Grilles Between Glass Only (GBGFV)
- ◆ Flat or Contour, White or Color Grilles Between Glass (GBGF / GBGC)
- Removable Wood Grilles (RG)
- ◆ Fixed Grilles (FXG)
- Vented Sidelite (No Impact) (6'6" & 6'8" only in 12" & 14") (8'0" only in 14")
- 🔄 WBDR Options
- 🔄 WBDR / HVHZ Options
- ⚠ 6'6" Height Available
- ‡ 7'0" Height Available
- 🚪 PVC Doorlite Frame\*\*

**Optional Dentil Shelf\*\***



## Clear Glass with Divided Lites *Continued*

|  |   |   |  |   |   |
|--|---|---|--|---|---|
| <b>S198SL</b><br>★<br>12" x 6'8"<br>14" x 6'8" | <b>S6062SL</b><br>★<br>10" x 6'8"<br>12" x 6'8" †<br>14" x 6'8" † | <b>S1400SL</b><br>★<br>12" x 6'8"<br>14" x 6'8" | <b>S898SL</b><br>★<br>12" x 8'0"<br>14" x 8'0" | <b>S1405SL</b><br>★<br>12" x 6'8"<br>14" x 6'8" | <b>S8145SL</b><br>★<br>12" x 8'0"<br>14" x 8'0" |
|--|---|---|--|---|---|



**19020T**  
★  
3'0" door + (2) 12" sidelites  
Continuous Sill Systems Only  
3'0" door + (2) 14" sidelites  
Continuous / Boxed Sill Systems  
Grille Sticks Applied



**19220T**  
★  
3'0" door + (2) 12" sidelites  
3'0" door + (2) 14" sidelites  
Continuous / Boxed Sill Systems  
Grille Sticks Applied



**19200T**  
★  
3'0" Door Only  
Grille Sticks Applied

Transoms can be stained or painted to match a Fiber-Classic or Smooth-Star door system.

## Clear Glass

### Fiber-Classic® Mahogany



|   |  |  |   |   |   |  |   |   |  |
|---|--|--|---|---|---|--|---|---|--|
| <b>FCM10</b><br>★<br>2'8" x 6'8"<br>2'10" x 6'8"<br>3'0" x 6'8" | <b>FCM870</b><br>★<br>2'8" x 8'0"<br>2'10" x 8'0"<br>3'0" x 8'0" | <b>FCM1283</b><br>★<br>2'0" x 6'8" ▽<br>2'4" x 6'8" †<br>2'6" x 6'8" †<br>2'8" x 6'8" †<br>2'10" x 6'8" †<br>3'0" x 6'8" † | <b>FCM81200</b><br>★<br>2'0" x 8'0" ▽<br>2'4" x 8'0" ▽<br>2'6" x 8'0" †<br>2'8" x 8'0" †<br>2'10" x 8'0" †<br>3'0" x 8'0" † | <b>FCM32</b><br>★<br>2'8" x 6'8"<br>2'10" x 6'8"<br>3'0" x 6'8" | <b>FCM62</b><br>★<br>2'8" x 6'8"<br>2'10" x 6'8"<br>3'0" x 6'8" | <b>FCM862</b><br>★<br>2'8" x 8'0"<br>2'10" x 8'0"<br>3'0" x 8'0" | <b>FCM6021</b><br>★<br>2'8" x 6'8"<br>2'10" x 6'8"<br>3'0" x 6'8" | <b>FCM6041</b><br>★<br>2'8" x 6'8"<br>2'10" x 6'8"<br>3'0" x 6'8" | <b>FCM670</b><br>★<br>2'4" x 6'8"<br>2'6" x 6'8" †<br>2'8" x 6'8" †<br>2'10" x 6'8" †<br>3'0" x 6'8" † |
|---|--|--|---|---|---|--|---|---|--|



|   |  |  |  |  |   |   |  |  |  |
|---|--|--|--|--|---|---|--|--|--|
| <b>FCM80</b><br>★<br>2'8" x 6'8"<br>2'10" x 6'8"<br>3'0" x 6'8" | <b>FCM160</b><br>★<br>2'8" x 6'8"<br>2'10" x 6'8"<br>3'0" x 6'8" | <b>FCM601</b><br>★<br>2'8" x 6'8"<br>2'10" x 6'8"<br>3'0" x 6'8" | <b>FCM132</b><br>★<br>2'8" x 6'8"<br>2'10" x 6'8"<br>3'0" x 6'8" | <b>FCM708</b><br>★<br>2'8" x 6'8"<br>2'10" x 6'8"<br>3'0" x 6'8" | <b>FCM8708</b><br>★<br>2'8" x 8'0"<br>2'10" x 8'0"<br>3'0" x 8'0" | <b>FCM61</b><br>★<br>2'8" x 6'8"<br>2'10" x 6'8"<br>3'0" x 6'8" | <b>FCM861</b><br>★<br>2'8" x 8'0"<br>2'10" x 8'0"<br>3'0" x 8'0" | <b>FCM12101SL</b><br>★<br>10" x 6'8"<br>12" x 6'8" †<br>14" x 6'8" † | <b>FCM81200SL</b><br>★<br>12" x 8'0"<br>14" x 8'0" |
|---|--|--|--|--|---|---|--|--|--|

\*Not recommended for use behind storm doors or to be painted dark colors, if exposed to direct sunlight.  
Note: See page 273 for important product details that may help with your purchase decision.



# Fiber-Classic® Oak



|  |   |  |  |   |  |
|--|---|--|--|---|--|
| <b>FCM870SL</b><br>★ 6<br>12" x 8'0"<br>14" x 8'0" | <b>FCM32SL</b><br>★ 6<br>12" x 6'8"<br>14" x 6'8" | <b>FCM881SL</b><br>★ 6<br>12" x 8'0"<br>14" x 8'0" | <b>FCM701SL</b><br>★<br>12" x 6'8"<br>14" x 6'8" | <b>FCM62SL</b><br>★ 6<br>12" x 6'8"<br>14" x 6'8" | <b>FCM862SL</b><br>★ 6<br>12" x 8'0"<br>14" x 8'0" |
|--|---|--|--|---|--|

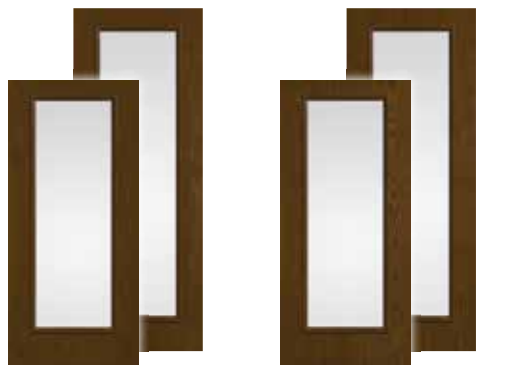

|   |  |   |  |
|---|--|---|--|
| <b>FC10</b><br>★ 6<br>2'6" x 6'8"<br>2'8" x 6'8" ‡<br>2'10" x 6'8" ‡<br>3'0" x 6'8" ‡ | <b>81200P</b><br>★ 6<br>2'8" x 8'0"<br>2'10" x 8'0"<br>3'0" x 8'0" | <b>1283</b><br>★ 6<br>2'0" x 6'8" ▽<br>2'4" x 6'8" ▲<br>2'6" x 6'8" ▲ ‡<br>2'8" x 6'8" ▲ ‡<br>2'10" x 6'8" ▲ ‡<br>3'0" x 6'8" ▲ ‡ | <b>81200</b><br>★ 6<br>2'0" x 8'0" ▽<br>2'4" x 8'0" ▽<br>2'6" x 8'0" ▽<br>2'8" x 8'0" ▽<br>2'10" x 8'0" ▽<br>3'0" x 8'0" ▽ |
|---|--|---|--|



|  |   |  |   |  |  |  |  |   |
|--|---|--|---|--|--|--|--|---|
| <b>FC32</b><br>★ 6<br>2'8" x 6'8"<br>2'10" x 6'8"<br>3'0" x 6'8" | <b>FC766</b><br>★ 6<br>2'8" x 6'8"<br>2'10" x 6'8"<br>3'0" x 6'8" | <b>81943P</b><br>★ 6<br>2'8" x 8'0"<br>2'10" x 8'0"<br>3'0" x 8'0" | <b>FC62</b><br>★ 6<br>2'6" x 6'8"<br>2'8" x 6'8" ‡<br>2'10" x 6'8" ‡<br>3'0" x 6'8" ‡ | <b>81929P</b><br>★ 6<br>2'8" x 8'0"<br>2'10" x 8'0"<br>3'0" x 8'0" | <b>FC670</b><br>★ 6<br>2'6" x 6'8" ‡<br>2'8" x 6'8" ‡<br>2'10" x 6'8" ‡<br>3'0" x 6'8" ‡ | <b>81971P</b><br>★ 6<br>2'8" x 8'0"<br>2'10" x 8'0"<br>3'0" x 8'0" | <b>FC48</b><br>★<br>2'8" x 6'8"<br>2'10" x 6'8"<br>3'0" x 6'8" | <b>FC710</b><br>★<br>2'8" x 6'8"<br>2'10" x 6'8"<br>3'0" x 6'8" |
|--|---|--|---|--|--|--|--|---|



|   |   |   |   |   |   |  |  |
|---|---|---|---|---|---|--|--|
| <b>FC160</b><br>★<br>2'8" x 6'8"<br>2'10" x 6'8"<br>3'0" x 6'8" | <b>FC789</b><br>★<br>2'8" x 6'8"<br>2'10" x 6'8"<br>3'0" x 6'8" | <b>FC132</b><br>★<br>2'8" x 6'8"<br>2'10" x 6'8"<br>3'0" x 6'8" | <b>FC80920</b><br>★ 6<br>2'8" x 6'8"<br>2'10" x 6'8"<br>3'0" x 6'8" | <b>FC86220</b><br>★ 6<br>2'8" x 8'0"<br>2'10" x 8'0"<br>3'0" x 8'0" | <b>FC708</b><br>★<br>2'8" x 6'8" ‡<br>2'10" x 6'8" ‡<br>3'0" x 6'8" ‡ | <b>FC8708</b><br>★<br>2'8" x 8'0"<br>2'10" x 8'0"<br>3'0" x 8'0" | <b>FC803</b><br>★<br>2'6" x 6'8"<br>2'8" x 6'8"<br>2'10" x 6'8"<br>3'0" x 6'8" |
|---|---|---|---|---|---|--|--|

Clear Glass *Continues on next page.*

### Key

- No Stile Lines
- ★ Low-E Glass (LE)
- 🐢 Turtle Glass
- ◆ Flat or Contour, White or Color Grilles Between Glass (GBGF / GBGC)
- Vented Sidelite (No Impact) (6'6" & 6'8" only in 12" & 14") (8'0" only in 14")
- 6 WBDR Options
- 6 WBDR / HVHZ Options
- ▲ 6'6" Height Available
- ‡ 7'0" Height Available
- ▽ PVC Doorlite Frame\*

### Optional Dentil Shelf\*



**Clear Glass** *Continued*



- |   |   |  |  |   |   |  |  |   |  |  |
|---|---|--|--|---|---|--|--|---|--|--|
| <b>FC61</b><br>★<br>2'6" x 6'8" ‡<br>2'8" x 6'8" ‡<br>2'10" x 6'8" ‡<br>3'0" x 6'8" ‡ | <b>FC861</b><br>★<br>2'8" x 8'0"<br>2'10" x 8'0"<br>3'0" x 8'0" | <b>FC47SL</b><br>★ 6<br>10" x 6'8"<br>12" x 6'8"<br>14" x 6'8" | <b>81200PSL</b><br>★ 6<br>12" x 8'0"<br>14" x 8'0" | <b>12101SL</b><br>★ 6<br>12" x 6'8" Δ ‡<br>14" x 6'8" Δ ‡ | <b>81200SL</b><br>★ 6<br>12" x 8'0"<br>14" x 8'0" | <b>FC32SL</b><br>★ 6<br>12" x 6'8"<br>14" x 6'8" | <b>81943PSL</b><br>★ 6<br>12" x 8'0"<br>14" x 8'0" | <b>FC701SL</b><br>★<br>12" x 6'8"<br>14" x 6'8" | <b>FC48SL</b><br>★ 6<br>12" x 6'8"<br>14" x 6'8" | <b>81929PSL</b><br>★ 6<br>12" x 8'0"<br>14" x 8'0" |
|---|---|--|--|---|---|--|--|---|--|--|

**Smooth-Star®**



- |   |   |  |   |   |   |  |   |   |  |
|---|---|--|---|---|---|--|---|---|--|
| <b>S118</b><br>★ 6<br>2'6" x 6'8" Δ<br>2'8" x 6'8" Δ ‡<br>2'10" x 6'8" Δ ‡<br>3'0" x 6'8" Δ ‡ | <b>S818</b><br>★ 6<br>2'6" x 8'0"<br>2'8" x 8'0"<br>2'10" x 8'0"<br>3'0" x 8'0" | <b>S140</b><br>★ 6<br>2'0" x 6'8" ▽<br>2'4" x 6'8" Δ<br>2'6" x 6'8" Δ<br>2'8" x 6'8" Δ ‡<br>2'10" x 6'8" Δ ‡<br>3'0" x 6'8" Δ ‡<br>3'6" x 6'8" | <b>S8140</b><br>★ 6<br>2'0" x 8'0" ▽<br>2'4" x 8'0" ▽<br>2'6" x 8'0"<br>2'8" x 8'0"<br>2'10" x 8'0"<br>3'0" x 8'0"<br>3'6" x 8'0" | <b>S80</b><br>★ 6<br>2'8" x 6'8"<br>2'10" x 6'8"<br>3'0" x 6'8" | <b>S90</b><br>★ 6<br>2'8" x 6'8"<br>2'10" x 6'8"<br>3'0" x 6'8" | <b>S880</b><br>★ 6<br>2'8" x 8'0"<br>2'10" x 8'0"<br>3'0" x 8'0" | <b>S206</b><br>★ 6<br>2'6" x 6'8"<br>2'8" x 6'8" ‡<br>2'10" x 6'8" ‡<br>3'0" x 6'8" ‡ | <b>S81929P</b><br>★ 6<br>2'8" x 8'0"<br>2'10" x 8'0"<br>3'0" x 8'0" | <b>S6021</b><br>★ 6<br>2'6" x 6'8"<br>2'8" x 6'8" ‡<br>2'10" x 6'8" ‡<br>3'0" x 6'8" ‡ |
|---|---|--|---|---|---|--|---|---|--|



- |   |  |   |  |  |  |  |  |
|---|--|---|--|--|--|--|--|
| <b>S6041</b><br>★ 6<br>2'8" x 6'8"<br>2'10" x 6'8"<br>3'0" x 6'8" | <b>S104</b><br>★ 6<br>2'4" x 6'8"<br>2'6" x 6'8"<br>2'8" x 6'8" ‡<br>2'10" x 6'8" ‡<br>3'0" x 6'8" ‡ | <b>S30</b><br>★ 6<br>2'8" x 6'8"<br>2'10" x 6'8"<br>3'0" x 6'8" | <b>S830</b><br>★ 6<br>2'8" x 8'0"<br>2'10" x 8'0"<br>3'0" x 8'0" | <b>S150</b><br>★<br>2'8" x 6'8"<br>2'10" x 6'8"<br>3'0" x 6'8" | <b>S289</b><br>★<br>2'8" x 6'8"<br>2'10" x 6'8"<br>3'0" x 6'8" | <b>S102</b><br>★<br>2'6" x 6'8" Δ<br>2'8" x 6'8" Δ ‡<br>2'10" x 6'8" Δ ‡<br>3'0" x 6'8" Δ ‡<br>3'6" x 6'8" | <b>S770</b><br>★<br>2'8" x 6'8"<br>2'10" x 6'8"<br>3'0" x 6'8" |
|---|--|---|--|--|--|--|--|

\*Not recommended for use behind storm doors or to be painted dark colors, if exposed to direct sunlight.  
Note: See page 273 for important product details that may help with your purchase decision.

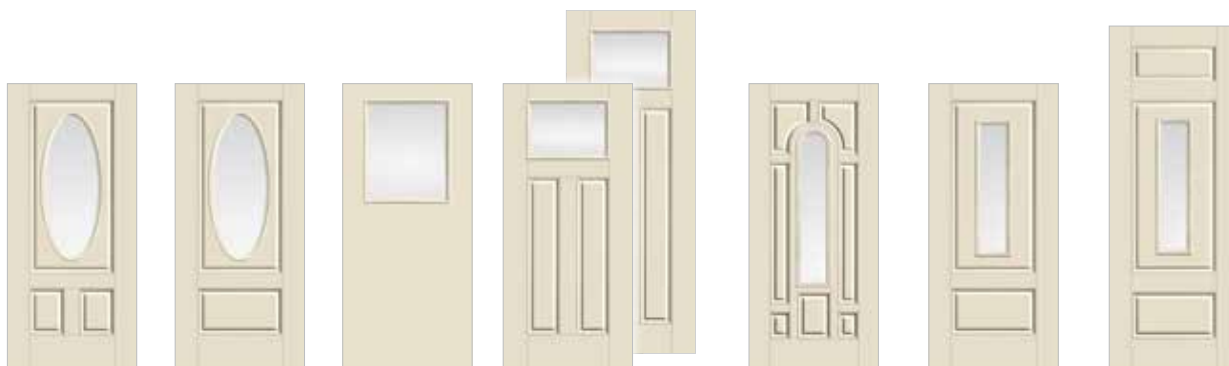

|   |  |   |  |   |   |   |  |
|---|--|---|--|---|---|---|--|
| <b>S6080</b><br>★<br>2'8" x 6'8"<br>2'10" x 6'8"<br>3'0" x 6'8" | <b>S992</b><br>★<br>2'8" x 6'8"<br>2'10" x 6'8"<br>3'0" x 6'8" | <b>S105</b><br>■ ★<br>2'6" x 6'8"<br>2'8" x 6'8" ‡<br>2'10" x 6'8" ‡<br>3'0" x 6'8" ‡ | <b>S601</b><br>★ 6<br>2'8" x 6'8"<br>2'10" x 6'8"<br>3'0" x 6'8" | <b>S8601</b><br>★ 6<br>2'8" x 8'0"<br>2'10" x 8'0"<br>3'0" x 8'0" | <b>S10</b><br>★<br>2'8" x 6'8"<br>2'10" x 6'8"<br>3'0" x 6'8" | <b>S9320</b><br>★ 6<br>2'8" x 6'8"<br>2'10" x 6'8"<br>3'0" x 6'8" | <b>S83120</b><br>★ 6<br>2'8" x 8'0"<br>2'10" x 8'0"<br>3'0" x 8'0" |
|---|--|---|--|---|---|---|--|



|  |   |  |   |   |  |   |  |  |  |  |
|--|---|--|---|---|--|---|--|--|--|--|
| <b>S708</b><br>★<br>2'8" x 6'8" ‡<br>2'10" x 6'8" ‡<br>3'0" x 6'8" ‡ | <b>S8708</b><br>★<br>2'8" x 8'0"<br>2'10" x 8'0"<br>3'0" x 8'0" | <b>S256</b><br>★<br>2'8" x 6'8"<br>2'10" x 6'8"<br>3'0" x 6'8" | <b>S296</b><br>★<br>2'6" x 6'8"<br>2'8" x 6'8" ‡<br>2'10" x 6'8" ‡<br>3'0" x 6'8" ‡ | <b>S896</b><br>★<br>2'6" x 8'0"<br>2'8" x 8'0"<br>2'10" x 8'0"<br>3'0" x 8'0" | <b>S100SL</b><br>★ 6<br>12" x 6'8"<br>14" x 6'8" | <b>S8601SL</b><br>★ 6<br>12" x 8'0"<br>14" x 8'0" | <b>S601SL</b><br>■ ★ 6<br>10" x 6'8"<br>12" x 6'8" ‡ ‡<br>14" x 6'8" ‡ ‡ | <b>S81086SL</b><br>■ ★ 6<br>12" x 8'0"<br>14" x 8'0" | <b>S751SL</b><br>★ 6<br>12" x 6'8"<br>14" x 6'8" | <b>S880SL</b><br>★ 6<br>12" x 8'0"<br>14" x 8'0" |
|--|---|--|---|---|--|---|--|--|--|--|



|  |  |  |  |
|--|--|--|--|
| <b>S761SL</b><br>★<br>12" x 6'8"<br>14" x 6'8" | <b>S210SL</b><br>★ 6<br>12" x 6'8"<br>14" x 6'8" | <b>S85910SL</b><br>★ 6<br>12" x 8'0"<br>14" x 8'0" | <b>S150SL</b><br>★<br>12" x 6'8"<br>14" x 6'8" |
|--|--|--|--|



**DLHRT**  
★  
3'0" door + (2) 12" sidelites  
3'0" door + (2) 14" sidelites  
Continuous / Boxed Sill Systems



**19220T**  
★  
3'0" door + (2) 12" sidelites  
3'0" door + (2) 14" sidelites  
Continuous / Boxed Sill Systems



**19020T**  
★  
3'0" door + (2) 12" sidelites  
Continuous Sill Systems Only  
3'0" door + (2) 14" sidelites  
Continuous / Boxed Sill Systems

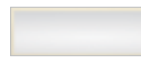

**19200T**  
★  
3'0" Door Only



**19210T**  
★  
12" & 14" Sidelite Only

Transoms can be stained or painted to match a Fiber-Classic or Smooth-Star door system.

**Key**

- No Stile Lines
- ★ Low-E Glass (LE)
- Turtle Glass
- Vented Sidelite (No Impact)  
(6'6" & 6'8" only in 12" & 14")  
(8'0" only in 14")
- 6 WBDR Options
- 6 WBDR / HVHZ Options
- △ 6'6" Height Available  
(6'6" & 6'8" only in 12" & 14")
- ‡ 7'0" Height Available
- PVC Doorlite Frame\*

**Optional Dentil Shelf\***





# Noise Reduction Doors

Therma-Tru® Noise Reduction doors deliver aesthetics with a commercial level of performance for residential projects. Ideal for multi-use and urban in-fill projects located near sources of noise pollution, our Noise Reduction doors provide a Sound Transmission Class (STC) rating of 36. Our Noise Reduction lites also offer added security from forced entry with laminated glass surrounded by a standard Lip-lite frame.

Note: Also available in decorative full-lite glass option in aluminum Lip-lite frame.

## Smooth-Star®

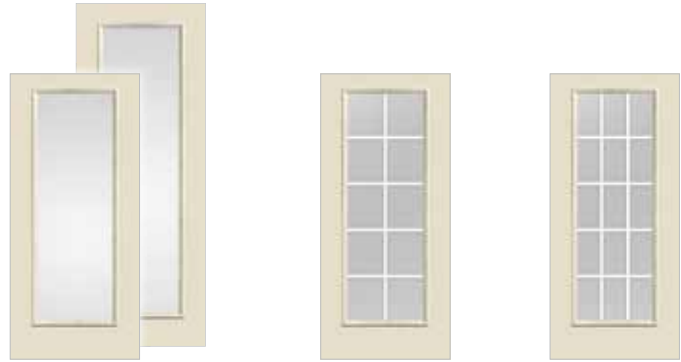

**S140STC**  
 ■ ★  
 2'6" x 6'8" ▲  
 2'8" x 6'8" ▲  
 2'10" x 6'8" ▲  
 3'0" x 6'8" ▲

**S8140STC**  
 ■ ★  
 2'6" x 8'0"  
 2'8" x 8'0"  
 2'10" x 8'0"  
 3'0" x 8'0"

**S141STC**  
 ■ ★ ◆  
 2'6" x 6'8" ▲  
 2'8" x 6'8" ▲  
 2'10" x 6'8" ▲  
 3'0" x 6'8" ▲

**S6063STC**  
 ■ ★ ◆  
 2'6" x 6'8" ▲  
 2'8" x 6'8" ▲  
 2'10" x 6'8" ▲  
 3'0" x 6'8" ▲

# Solid Panel

## Fiber-Classic® Mahogany



**FCM31**  
 6  
 2'8" x 6'8"  
 2'10" x 6'8"  
 3'0" x 6'8"



**FCM220**  
 6  
 2'8" x 6'8"  
 2'10" x 6'8"  
 3'0" x 6'8"



**FCM205**  
 6  
 2'8" x 6'8"  
 2'10" x 6'8"  
 3'0" x 6'8"



**FCM755**  
 6  
 2'8" x 6'8"  
 2'10" x 6'8"  
 3'0" x 6'8"



**FCM600**  
 6  
 2'8" x 6'8"  
 2'10" x 6'8"  
 3'0" x 6'8"



**FCM134**  
 6  
 2'8" x 6'8"  
 2'10" x 6'8"  
 3'0" x 6'8"



**FCM60**  
 6  
 2'8" x 6'8"  
 2'10" x 6'8"  
 3'0" x 6'8"



**FCM860**  
 6  
 2'8" x 8'0"  
 2'10" x 8'0"  
 3'0" x 8'0"

**FCM1000**  
 6  
 2'0" x 6'8"  
 2'4" x 6'8" ▲  
 2'6" x 6'8" ▲ ‡  
 2'8" x 6'8" ▲ ‡  
 2'10" x 6'8" ▲ ‡  
 3'0" x 6'8" ▲ ‡

**FCM81000**  
 6  
 2'0" x 8'0"  
 2'4" x 8'0"  
 2'6" x 8'0"  
 2'8" x 8'0"  
 2'10" x 8'0"  
 3'0" x 8'0"

## Fiber-Classic® Oak



**FC31**  
 6  
 2'8" x 6'8"  
 2'10" x 6'8"  
 3'0" x 6'8"



**FC809**  
 6  
 2'8" x 6'8"  
 2'10" x 6'8"  
 3'0" x 6'8"



**FC862**  
 6  
 2'8" x 8'0"  
 2'10" x 8'0"  
 3'0" x 8'0"

\*Available with elevated 10" bottom rail.

Note: See page 273 for important product details that may help with your purchase decision.





**FC808**  
 2'8" x 6'8"  
 2'10" x 6'8"  
 3'0" x 6'8"

**FC755**  
 2'8" x 6'8"  
 2'10" x 6'8"  
 3'0" x 6'8"

**FC134**  
 2'8" x 6'8"  
 2'10" x 6'8"  
 3'0" x 6'8"

**FC60\***  
 2'6" x 6'8" ‡  
 2'8" x 6'8" ‡  
 2'10" x 6'8" ‡  
 3'0" x 6'8" ‡

**FC860**  
 2'8" x 8'0"  
 2'10" x 8'0"  
 3'0" x 8'0"

**1000**  
  2'0" x 6'8"  
 2'4" x 6'8" △  
 2'6" x 6'8" △ ‡  
 2'8" x 6'8" △ ‡  
 2'10" x 6'8" △ ‡  
 3'0" x 6'8" △ ‡

**81000**  
  2'0" x 8'0"  
 2'4" x 8'0"  
 2'6" x 8'0"  
 2'8" x 8'0"  
 2'10" x 8'0"  
 3'0" x 8'0"

## Smooth-Star®



**S93**  
 2'8" x 6'8"  
 2'10" x 6'8"  
 3'0" x 6'8"

**S220\***  
 2'8" x 6'8" ‡  
 2'10" x 6'8" ‡  
 3'0" x 6'8" ‡

**S8200**  
 2'8" x 8'0"  
 2'10" x 8'0"  
 3'0" x 8'0"

**S200**  
 2'8" x 6'8"  
 2'8" x 6'8"  
 2'10" x 6'8"  
 3'0" x 6'8"

**S897**  
 2'8" x 8'0"  
 2'10" x 8'0"  
 3'0" x 8'0"

**S205**  
 2'8" x 6'8"  
 2'10" x 6'8"  
 3'0" x 6'8"

**S8201**  
 2'8" x 8'0"  
 2'10" x 8'0"  
 3'0" x 8'0"

**S31**  
 2'8" x 6'8"  
 2'10" x 6'8"  
 3'0" x 6'8"

**S831**  
 2'8" x 8'0"  
 2'10" x 8'0"  
 3'0" x 8'0"

**S960**  
 2'8" x 6'8"  
 2'10" x 6'8"  
 3'0" x 6'8"

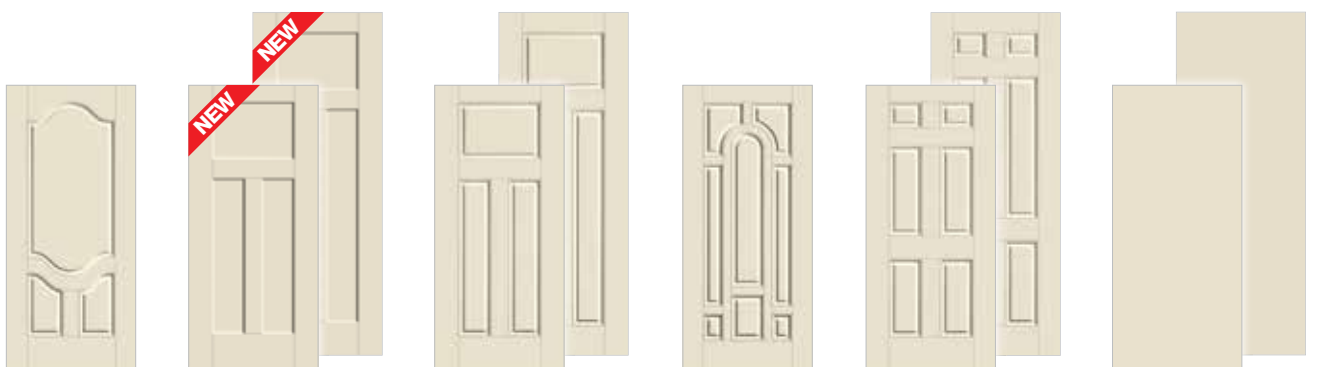

**S755**  
 2'8" x 6'8"  
 2'10" x 6'8"  
 3'0" x 6'8"

**S4800**  
 2'8" x 6'8"  
 2'10" x 6'8"  
 3'0" x 6'8"

**S84800**  
 2'8" x 8'0"  
 2'10" x 8'0"  
 3'0" x 8'0"



**S600**  
 2'8" x 6'8"  
 2'10" x 6'8"  
 3'0" x 6'8"



**S8600**  
 2'8" x 8'0"  
 2'10" x 8'0"  
 3'0" x 8'0"

**S11**  
 2'8" x 6'8"  
 2'10" x 6'8"  
 3'0" x 6'8"

**S210\***  
 2'6" x 6'8"  
 2'8" x 6'8" ‡  
 2'10" x 6'8" ‡  
 3'0" x 6'8" ‡

**S810**  
 2'6" x 8'0"  
 2'8" x 8'0"  
 2'10" x 8'0"  
 3'0" x 8'0"

**S100**  
  2'0" x 6'8"  
 2'4" x 6'8" △  
 2'6" x 6'8" △  
 2'8" x 6'8" △ ‡  
 2'10" x 6'8" △ ‡  
 3'0" x 6'8" △ ‡  
 3'6" x 6'8"

**S81000**  
  2'0" x 8'0"  
 2'4" x 8'0"  
 2'6" x 8'0"  
 2'8" x 8'0"  
 2'10" x 8'0"  
 3'0" x 8'0"  
 3'6" x 8'0"

### Key

 No Stile Lines

 Low-E Glass (LE)

 Flat White Grilles Between Glass Only (GBG-F)

 WBDR / HVHZ Options

 6'6" Height Available

 7'0" Height Available

# Profiles™ Steel



202

- Versatile, affordable options.



Coupling distinctive styling with affordability, Profiles steel doors offer versatile front entry and house-to-garage options. Designed to suit multiple home styles, these doors feature triple-shadowed panel embossments for greater detail.

Top: Profiles, Frosted Images Glass, Door – 206EHD, Sidelite – 289ESLHD  
 Bottom: Profiles, Texas Star Glass, Door – 1035HD, Sidelites – 1032SLHD



# Traditions Steel



• Back to basics.



It's back to basics with Traditions. This line of steel doors combines attractive designs and value-based options to create a great, cost-conscious alternative for front entry and house-to-garage.

Top: Traditions, Clear Glass with SDLs, Door – TS3000-6C, Sidelites – 100SL  
Bottom: Traditions, Clear Glass with SDLs, Doors – TS263

# Profiles™ & Traditions Steel Doors

Find style at an affordable price point with options to match any home style and budget in Profiles and Traditions doors. Fire-rated options on 6'8" solid-panel doors make a perfect choice for house-to-garage.

- 1-¼" lock stiles.
- 12-½" lock blocks.
- No stile lines.
- Primed, ready-to-paint surface.

 WBDR / HVHZ Options: Look for this icon to find door styles that can be configured for WBDR or HVHZ.\*

 20-Minute Fire-rated options available on 6'8" solid-panel doors. See pages 227–231.



## Profiles™ Steel

Features 24-gauge steel, smooth surface and triple-shadowed panel embossments for greater definition.



## Traditions Steel

Features 25-gauge steel, standard embossed smooth surface. All 8'0" doors are 24-gauge steel with standard embossments.



■ = Available  
 • = Not Applicable  
 P = Paint

|           |            |
|-----------|------------|
| Profiles™ | Traditions |
|-----------|------------|

### Door Widths

|       |   |   |
|-------|---|---|
| 2'0"  | ■ | ■ |
| 2'4"  | ■ | ■ |
| 2'6"  | ■ | ■ |
| 2'8"  | ■ | ■ |
| 2'10" | ■ | ■ |
| 3'0"  | ■ | ■ |
| 3'6"  | ■ | • |

### Door Heights

|      |   |   |
|------|---|---|
| 6'6" | ■ | ■ |
| 6'8" | ■ | ■ |
| 7'0" | ■ | • |
| 8'0" | • | ■ |

### Glass Options

|                         |    |    |
|-------------------------|----|----|
| Decorative              | 14 | 14 |
| Privacy & Textured      | 5  | 5  |
| Internal Blinds         | ■  | ■  |
| Screen Vented Lites     | ■  | ■  |
| Simulated Divided Lites | ■  | ■  |
| Grilles Between Glass   | ■  | ■  |
| Removable Wood Grilles  | ■  | ■  |
| Fixed Grilles           | ■  | ■  |
| Low-E                   | ■  | ■  |
| Clear                   | ■  | ■  |

### Additional Options

|        |   |   |
|--------|---|---|
| Finish | P | P |
|--------|---|---|

## Retrofit Hinged Patio Doors

Replacing common slider sizes? Find hinged patio door options in this section. For more about our patio door systems, see pages 246–248.

5'0" Patio Opening = (2) 2'4" Doors  
 6'0" Patio Opening = (2) 2'10" Doors

\*Please verify that there is a Therma-Tru product approval for the configuration before buying.

\*\*Decorative glass designs are shown in Profiles only.

Note: Finish colors may vary from an actual application due to fluctuations in finishing or printing. Glass privacy ratings may be more or less than indicated, based on glass design and size of glass. Glass designs may differ from depiction due to size and hand craftsmanship of glass. See your Therma-Tru seller or visit [www.thermatru.com](http://www.thermatru.com) for more, including details on limited warranties and exclusions, ENERGY STAR qualified products and product approvals.

# Decorative & Specialty Glass Designs\*\*



Black Nickel      Brushed Nickel

**Blackstone**™ Page 207  
Glass Privacy Rating: **7**



Black Nickel      Brass

**Crystalline**™ Page 207  
Glass Privacy Rating: **7**



Art Glass / Black Nickel      Brushed Nickel

**Sedona** Page 208  
Glass Privacy Rating: **7**



Wrought Iron

**Salinas** Page 209  
Glass Privacy Rating: **10**



Black Nickel      Brushed Nickel

**Maple Park** Page 209  
Glass Privacy Rating: **6**



Black Nickel

**Avonlea** Page 210  
Glass Privacy Rating: **4**

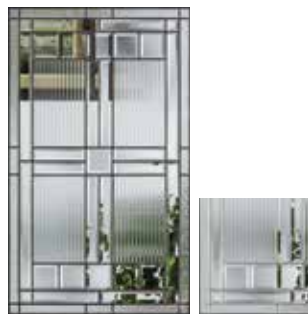

Black Nickel      Brushed Nickel

**Saratoga**™ Page 211  
Glass Privacy Rating: **7**



Brushed Nickel

**Texas Star** Page 211  
Glass Privacy Rating: **5**



Black Nickel      Brass

**Wellesley**™ Page 212  
Glass Privacy Rating: **6**



Wrought Iron

**Riserva**™ Page 212  
Glass Privacy Rating: **10**



Black Nickel      Brass

**Concorde**™ Page 213  
Glass Privacy Rating: **8**



Black Nickel      Brushed Nickel

**Kensington**™ Page 214  
Glass Privacy Rating: **8**



Black Nickel

**Axis**™ Page 214  
Glass Privacy Rating: **7**



**Frosted Images** Page 215  
Glass Privacy Rating: **8**



**Internal Blinds** Page 217, 222



**Screen Vented** Page 217, 222

## Glass Privacy Rating Scale

**1 2 3 4 5 6 7 8 9 10**

Clear

Opaque



## Privacy & Textured Glass

Pages 216, 221



**Satin Etch Glass (XE)**  
Glass Privacy Rating: **10**



**Chord Glass (XC)**  
Glass Privacy Rating: **10**



**Chinchilla Glass (XJ)**  
Glass Privacy Rating: **10**



**Rainglass (XR)**  
Glass Privacy Rating: **8**



**Granite Glass (XN)**  
Glass Privacy Rating: **10**

### Glass Privacy Rating Scale



Clear

Opaque

Also Available:

**Divided Lites** Pages 216, 217, 221, 223

**Clear Glass** Pages 217, 223



Note: See page 273 for important product details that may help with your purchase decision.

Bottom: Profiles, Salinas Glass, Door – 968HD, Sidelites – 971SLHD

# Blackstone®

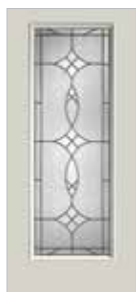

**310**  
 ◆ ■ ■ 6  
 2'6" x 6'8" † ‡  
 2'8" x 6'8" † ‡  
 2'10" x 6'8" † ‡  
 3'0" x 6'8" † ‡  
 3'6" x 6'8" † ‡



**1037HD**  
 ◆ ■ ■ 6  
 2'8" x 6'8"  
 2'10" x 6'8"  
 3'0" x 6'8"



**309HD**  
 ◆ ■ ■ 6  
 2'6" x 6'8" ‡  
 2'8" x 6'8" ‡  
 2'10" x 6'8" ‡  
 3'0" x 6'8" ‡



**1001HD**  
 ◆ ■ ■ 6  
 2'8" x 6'8"  
 2'10" x 6'8"  
 3'0" x 6'8"



**1117HD**  
 ◆ ■ ■ 6  
 2'8" x 6'8"  
 2'10" x 6'8"  
 3'0" x 6'8"



**311HD**  
 ◆ ■ ■  
 2'6" x 6'8" ‡  
 2'8" x 6'8" ‡  
 2'10" x 6'8" ‡  
 3'0" x 6'8" ‡



**1025HD**  
 ◆ ■ ■  
 2'8" x 6'8"  
 2'10" x 6'8"  
 3'0" x 6'8"



**310SL**  
 ◆ ■ ■ 6  
 10" x 6'8"  
 12" x 6'8" ‡  
 14" x 6'8" ‡



**1037SLHD**  
 ◆ ■ ■ 6  
 12" x 6'8"  
 14" x 6'8"



**311SLHD**  
 ◆ ■ ■ 6  
 12" x 6'8" ‡  
 14" x 6'8" ‡



**BSHRT**  
 ◆ ■ ■  
 3'0" door + (2) 12" sidelites  
 3'0" door + (2) 14" sidelites  
 Continuous Sill Systems Only



**BSRRT**  
 ◆ ■ ■  
 3'0" door + (2) 12" sidelites  
 Continuous Sill Systems Only

# Crystalline™



**916**  
 ◆ ■ ■ 6  
 2'6" x 6'8" † ‡  
 2'8" x 6'8" † ‡  
 2'10" x 6'8" † ‡  
 3'0" x 6'8" † ‡  
 3'6" x 6'8" † ‡



**1042HD**  
 ◆ ■ ■ 6  
 2'8" x 6'8"  
 2'10" x 6'8"  
 3'0" x 6'8"



**926HD**  
 ◆ ■ ■ 6  
 2'6" x 6'8" ‡  
 2'8" x 6'8" ‡  
 2'10" x 6'8" ‡  
 3'0" x 6'8" ‡



**991HD**  
 ◆ ■ ■ 6  
 2'8" x 6'8"  
 2'10" x 6'8"  
 3'0" x 6'8"



**1119HD**  
 ◆ ■ ■ 6  
 2'8" x 6'8"  
 2'10" x 6'8"  
 3'0" x 6'8"



**950HD**  
 ◆ ■ ■  
 2'8" x 6'8" ‡  
 2'10" x 6'8" ‡  
 3'0" x 6'8" ‡



**930HD**  
 ◆ ■ ■  
 2'6" x 6'8" ‡  
 2'8" x 6'8" ‡  
 2'10" x 6'8" ‡  
 3'0" x 6'8" ‡



**953HD**  
 ◆ ■ ■  
 2'8" x 6'8" ‡  
 2'10" x 6'8" ‡  
 3'0" x 6'8" ‡

**Crystalline Glass** Continues on next page.

## Key

- ◆ Black Nickel Caming (1D)
- Brushed Nickel Caming (1C)
- ❖ Brass Caming (1A)
- 6 WBDR / HVHZ Options
- △ 6'6" Height Available
- ‡ 7'0" Height Available

**Crystalline™ Glass** *Continued*



**1055HD**  
 ◆ ◆ ◆  
 2'8" x 6'8" ‡  
 2'10" x 6'8" ‡  
 3'0" x 6'8" ‡



**936HD**  
 ◆ ◆ ◆  
 2'8" x 6'8" ‡  
 2'10" x 6'8" ‡  
 3'0" x 6'8" ‡



**916SL**  
 ◆ ◆ ◆ 6  
 10" x 6'8" ‡  
 12" x 6'8" ‡  
 14" x 6'8" ‡



**956SLHD**  
 ◆ ◆ ◆ 6  
 12" x 6'8" ‡  
 14" x 6'8" ‡

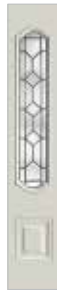

**975SLHD**  
 ◆ ◆ ◆  
 12" x 6'8" ‡  
 14" x 6'8" ‡



**930SLHD**  
 ◆ ◆ ◆ 6  
 12" x 6'8" ‡  
 14" x 6'8" ‡



**950SLHD**  
 ◆ ◆ ◆  
 12" x 6'8" ‡  
 14" x 6'8" ‡



**936SLHD**  
 ◆ ◆ ◆  
 12" x 6'8" ‡  
 14" x 6'8" ‡



**19820T**  
 ◆ ◆ ◆  
 3'0" door + (2) 12" sidelites  
 3'0" door + (2) 14" sidelites  
 Continuous / Boxed Sill Systems



**19080T**  
 ◆ ◆ ◆  
 3'0" door + (2) 12" sidelites  
 Continuous Sill Systems Only  
 3'0" door + (2) 14" sidelites  
 Continuous / Boxed Sill Systems



**19810T**  
 ◆ ◆ ◆  
 12" & 14" Sidelite Only



**BLHRT**  
 ◆ ◆ ◆  
 3'0" door + (2) 12" sidelites  
 3'0" door + (2) 14" sidelites  
 Continuous / Boxed Sill Systems



**19800T**  
 ◆ ◆ ◆  
 3'0" Door Only

**Sedona**

Note: Shown in art glass with black nickel caming.



**139-A**  
 ▶  
**139**  
 ◆ ◆ ◆  
 2'6" x 6'8" ‡  
 2'8" x 6'8" ‡  
 2'10" x 6'8" ‡  
 3'0" x 6'8" ‡  
 3'6" x 6'8" ‡



**965HD-A**  
 ▶  
**965HD**  
 ◆ ◆ ◆  
 2'8" x 6'8" ‡  
 2'10" x 6'8" ‡  
 3'0" x 6'8" ‡



**211HD-A**  
 ▶  
**211HD**  
 ◆ ◆ ◆  
 2'6" x 6'8" ‡  
 2'8" x 6'8" ‡  
 2'10" x 6'8" ‡  
 3'0" x 6'8" ‡



**996HD-A**  
 ▶  
**996HD**  
 ◆ ◆ ◆  
 2'8" x 6'8" ‡  
 2'10" x 6'8" ‡  
 3'0" x 6'8" ‡



**1114HD-A**  
 ▶  
**1114HD**  
 ◆ ◆ ◆  
 2'8" x 6'8" ‡  
 2'10" x 6'8" ‡  
 3'0" x 6'8" ‡



**294HD-A**  
 ▶  
**294HD**  
 ◆ ◆ ◆  
 2'6" x 6'8" ‡  
 2'8" x 6'8" ‡  
 2'10" x 6'8" ‡  
 3'0" x 6'8" ‡



**139SL-A**  
 ▶  
**139SL**  
 ◆ ◆ ◆  
 10" x 6'8" ‡  
 12" x 6'8" ‡  
 14" x 6'8" ‡



**965SLHD-A**  
 ▶  
**965SLHD**  
 ◆ ◆ ◆  
 12" x 6'8" ‡  
 14" x 6'8" ‡



**294SLHD-A**  
 ▶  
**294SLHD**  
 ◆ ◆ ◆  
 12" x 6'8" ‡  
 14" x 6'8" ‡



**19520T-A** ▶  
**19520T** ◆ ◆ ◆  
 3'0" door + (2) 12" sidelites  
 3'0" door + (2) 14" sidelites  
 Continuous Sill Systems Only



**19055T-A** ▶  
**19055T** ◆ ◆ ◆  
 3'0" door + (2) 12" sidelites  
 3'0" door + (2) 14" sidelites  
 Continuous Sill Systems Only



# Salinas®

Note: Product images show exterior side of door.



**369**  
**X 6**  
 2'6" x 6'8" Δ ‡  
 2'8" x 6'8" Δ ‡  
 2'10" x 6'8" Δ ‡  
 3'0" x 6'8" Δ ‡  
 3'6" x 6'8" ‡

**968HD**  
**X 6**  
 2'8" x 6'8"  
 2'10" x 6'8"  
 3'0" x 6'8"

**374HD**  
**X 6**  
 2'6" x 6'8" ‡  
 2'8" x 6'8" ‡  
 2'10" x 6'8" ‡  
 3'0" x 6'8" ‡

**1002HD**  
**X 6**  
 2'8" x 6'8"  
 2'10" x 6'8"  
 3'0" x 6'8"

**1115HD**  
**X 6**  
 2'8" x 6'8"  
 2'10" x 6'8"  
 3'0" x 6'8"

**372HD**  
**X**  
 2'8" x 6'8" ‡  
 2'10" x 6'8" ‡  
 3'0" x 6'8" ‡

**371HD**  
**X**  
 2'6" x 6'8" ‡  
 2'8" x 6'8" ‡  
 2'10" x 6'8" ‡  
 3'0" x 6'8" ‡



**369SL**  
**X 6**  
 10" x 6'8"  
 12" x 6'8" ‡  
 14" x 6'8" ‡

**971SLHD**  
**X 6**  
 12" x 6'8"  
 14" x 6'8"

**371SLHD**  
**X 6**  
 12" x 6'8" ‡  
 14" x 6'8" ‡

**SART**  
**X**  
 3'0" door + (2) 12" sidelites  
 Continuous Sill Systems Only

# Maple Park®



**1006**  
**◆ 6**  
 2'8" x 6'8" ‡  
 2'10" x 6'8" Δ ‡  
 3'0" x 6'8" Δ ‡  
 3'6" x 6'8" ‡

**1009HD**  
**◆ 6**  
 2'8" x 6'8"  
 2'10" x 6'8"  
 3'0" x 6'8"

**1007HD**  
**◆ 6**  
 2'8" x 6'8" ‡  
 2'10" x 6'8" ‡  
 3'0" x 6'8" ‡

**1011HD**  
**◆ 6**  
 2'8" x 6'8"  
 2'10" x 6'8"  
 3'0" x 6'8"

**1116HD**  
**◆ 6**  
 2'8" x 6'8"  
 2'10" x 6'8"  
 3'0" x 6'8"

**1008HD**  
**◆**  
 2'6" x 6'8" ‡  
 2'8" x 6'8" ‡  
 2'10" x 6'8" ‡  
 3'0" x 6'8" ‡

## Key

- ▶ Art Glass / Black Nickel Caming (1D)
- ◆ Black Nickel Caming (1D)
- Brushed Nickel Caming (1C)
- ◇ Brass Caming (1A)
- X Wrought Iron (1W)
- 6 WBDR / HVHZ Options
- Δ 6'6" Height Available
- ‡ 7'0" Height Available

Maple Park Glass *Continued*



**736HD**  
 ◆ ■  
 2'8" x 6'8" ‡  
 2'10" x 6'8" ‡  
 3'0" x 6'8" ‡



**1006SL**  
 ◆ ■ ■ 6  
 10" x 6'8"  
 12" x 6'8" ‡  
 14" x 6'8" ‡



**1009SLHD**  
 ◆ ■ ■ 6  
 12" x 6'8"  
 14" x 6'8"



**1007SLHD**  
 ◆ ■ ■ 6  
 12" x 6'8" ‡  
 14" x 6'8" ‡



**FWRT**  
 ◆ ■ ■  
 3'0" door + (2) 12" sidelites  
 3'0" door + (2) 14" sidelites  
 Continuous Sill Systems Only

**Avonlea®**

Note: Product images show exterior side of door.



**1027**  
 ◆ 6  
 2'8" x 6'8" ‡  
 2'10" x 6'8" ‡  
 3'0" x 6'8" ‡  
 3'6" x 6'8" ‡



**1038HD**  
 ◆ 6  
 2'8" x 6'8"  
 2'10" x 6'8"  
 3'0" x 6'8"



**1031HD**  
 ◆ 6  
 2'8" x 6'8" ‡  
 2'10" x 6'8" ‡  
 3'0" x 6'8" ‡



**1034HD**  
 ◆ 6  
 2'8" x 6'8"  
 2'10" x 6'8"  
 3'0" x 6'8"



**1107HD**  
 ◆ 6  
 2'8" x 6'8"  
 2'10" x 6'8"  
 3'0" x 6'8"



**1044HD**  
 ◆  
 2'6" x 6'8" ‡  
 2'8" x 6'8" ‡  
 2'10" x 6'8" ‡  
 3'0" x 6'8" ‡



**1047HD**  
 ◆  
 2'8" x 6'8"  
 2'10" x 6'8"  
 3'0" x 6'8"



**1027SL**  
 ◆ 6  
 10" x 6'8"  
 12" x 6'8" ‡  
 14" x 6'8" ‡



**1038SLHD**  
 ◆ 6  
 12" x 6'8"  
 14" x 6'8"



**1031SLHD**  
 ◆ 6  
 12" x 6'8" ‡  
 14" x 6'8" ‡



**AVRT**  
 ◆  
 3'0" door + (2) 12" sidelites  
 3'0" door + (2) 14" sidelites  
 Continuous Sill Systems Only

# Saratoga™



**610**  
 ◆ ■ ■ 6  
 2'6" x 6'8" △ ‡  
 2'8" x 6'8" △ ‡  
 2'10" x 6'8" △ ‡  
 3'0" x 6'8" △ ‡  
 3'6" x 6'8" ‡



**1039HD**  
 ◆ ■ ■ 6  
 2'8" x 6'8"  
 2'10" x 6'8"  
 3'0" x 6'8"



**613HD**  
 ◆ ■ ■ 6  
 2'6" x 6'8" ‡  
 2'8" x 6'8" ‡  
 2'10" x 6'8" ‡  
 3'0" x 6'8" ‡



**988HD**  
 ◆ ■ ■ 6  
 2'8" x 6'8"  
 2'10" x 6'8"  
 3'0" x 6'8"



**1112HD**  
 ◆ ■ ■ 6  
 2'8" x 6'8"  
 2'10" x 6'8"  
 3'0" x 6'8"



**615HD**  
 ◆ ■ ■  
 2'6" x 6'8" ‡  
 2'8" x 6'8" ‡  
 2'10" x 6'8" ‡  
 3'0" x 6'8" ‡



**707HD**  
 ◆ ■ ■  
 2'8" x 6'8" ‡  
 2'10" x 6'8" ‡  
 3'0" x 6'8" ‡



**610SL**  
 ◆ ■ ■ 6  
 10" x 6'8"  
 12" x 6'8" ‡  
 14" x 6'8" ‡



**1039SLHD**  
 ◆ ■ ■ 6  
 12" x 6'8"  
 14" x 6'8"



**615SLHD**  
 ◆ ■ ■ 6  
 12" x 6'8" ‡  
 14" x 6'8" ‡



**19740T**  
 ◆ ■ ■  
 3'0" Door Only



**19750T**  
 ◆ ■ ■  
 3'0" door + (2) 12" sidelites  
 Continuous Sill Systems Only

# Texas Star



**1029**  
 ■ ■ 6  
 2'8" x 6'8" ‡  
 2'10" x 6'8" △ ‡  
 3'0" x 6'8" △ ‡  
 3'6" x 6'8" ‡



**1040HD**  
 ■ ■ 6  
 2'8" x 6'8"  
 2'10" x 6'8"  
 3'0" x 6'8"



**1032HD**  
 ■ ■ 6  
 2'8" x 6'8" ‡  
 2'10" x 6'8" ‡  
 3'0" x 6'8" ‡



**1035HD**  
 ■ ■ 6  
 2'8" x 6'8"  
 2'10" x 6'8"  
 3'0" x 6'8"



**1111HD**  
 ■ ■ 6  
 2'8" x 6'8"  
 2'10" x 6'8"  
 3'0" x 6'8"



**1045HD**  
 ■ ■  
 2'6" x 6'8" ‡  
 2'8" x 6'8" ‡  
 2'10" x 6'8" ‡  
 3'0" x 6'8" ‡



**1048HD**  
 ■ ■  
 2'8" x 6'8"  
 2'10" x 6'8"  
 3'0" x 6'8"



**1029SL**  
 ■ ■ 6  
 10" x 6'8"  
 12" x 6'8" ‡  
 14" x 6'8" ‡



**1040SLHD**  
 ■ ■ 6  
 12" x 6'8"  
 14" x 6'8"



**1032SLHD**  
 ■ ■ 6  
 12" x 6'8" ‡  
 14" x 6'8" ‡

## Key

- ◆ Black Nickel Caming (1D)
- ■ Brushed Nickel Caming (1C)
- 6 WBDR / HVHZ Options

- △ 6'6" Height Available
- ‡ 7'0" Height Available



# Wellesley™



**620**  
 ◆ ◆ ◆ ◆ ◆ ◆  
 2'6" x 6'8" † ‡  
 2'8" x 6'8" † ‡  
 2'10" x 6'8" † ‡  
 3'0" x 6'8" † ‡  
 3'6" x 6'8" ‡



**1041HD**  
 ◆ ◆ ◆ ◆ ◆ ◆  
 2'8" x 6'8" † ‡  
 2'10" x 6'8" † ‡  
 3'0" x 6'8" † ‡



**623HD**  
 ◆ ◆ ◆ ◆ ◆ ◆  
 2'6" x 6'8" † ‡  
 2'8" x 6'8" † ‡  
 2'10" x 6'8" † ‡  
 3'0" x 6'8" † ‡



**989HD**  
 ◆ ◆ ◆ ◆ ◆ ◆  
 2'8" x 6'8" † ‡  
 2'10" x 6'8" † ‡  
 3'0" x 6'8" † ‡



**1120HD**  
 ◆ ◆ ◆ ◆ ◆ ◆  
 2'8" x 6'8" † ‡  
 2'10" x 6'8" † ‡  
 3'0" x 6'8" † ‡



**625HD**  
 ◆ ◆ ◆ ◆ ◆ ◆  
 2'6" x 6'8" † ‡  
 2'8" x 6'8" † ‡  
 2'10" x 6'8" † ‡  
 3'0" x 6'8" † ‡



**1022HD**  
 ◆ ◆ ◆ ◆ ◆ ◆  
 2'8" x 6'8" † ‡  
 2'10" x 6'8" † ‡  
 3'0" x 6'8" † ‡



**721HD**  
 ◆ ◆ ◆ ◆ ◆ ◆  
 2'8" x 6'8" † ‡  
 2'10" x 6'8" † ‡  
 3'0" x 6'8" † ‡



**620SL**  
 ◆ ◆ ◆ ◆ ◆ ◆  
 10" x 6'8" † ‡  
 12" x 6'8" † ‡  
 14" x 6'8" † ‡



**1041SLHD**  
 ◆ ◆ ◆ ◆ ◆ ◆  
 12" x 6'8" † ‡  
 14" x 6'8" † ‡



**625SLHD**  
 ◆ ◆ ◆ ◆ ◆ ◆  
 12" x 6'8" † ‡  
 14" x 6'8" † ‡



**19720T**  
 ◆ ◆ ◆ ◆ ◆ ◆  
 3'0" Door Only



**19730T**  
 ◆ ◆ ◆ ◆ ◆ ◆  
 3'0" door + (2) 12" sidelites  
 Continuous Sill Systems Only



**WLHRT**  
 ◆ ◆ ◆ ◆ ◆ ◆  
 3'0" door + (2) 12" sidelites  
 3'0" door + (2) 14" sidelites  
 Continuous Sill Systems Only

# Riserva™

Note: Product images show exterior side of door.



**571**  
 X 6  
 2'6" x 6'8" † ‡  
 2'8" x 6'8" † ‡  
 2'10" x 6'8" † ‡  
 3'0" x 6'8" † ‡  
 3'6" x 6'8" † ‡



**544HD**  
 X 6  
 2'8" x 6'8" † ‡  
 2'10" x 6'8" † ‡  
 3'0" x 6'8" † ‡



**582HD**  
 X 6  
 2'6" x 6'8" † ‡  
 2'8" x 6'8" † ‡  
 2'10" x 6'8" † ‡  
 3'0" x 6'8" † ‡



**576HD**  
 X 6  
 2'8" x 6'8" † ‡  
 2'10" x 6'8" † ‡  
 3'0" x 6'8" † ‡



**578HD**  
 X 6  
 2'8" x 6'8" † ‡  
 2'10" x 6'8" † ‡  
 3'0" x 6'8" † ‡



**588HD**  
 X  
 2'6" x 6'8" † ‡  
 2'8" x 6'8" † ‡  
 2'10" x 6'8" † ‡  
 3'0" x 6'8" † ‡

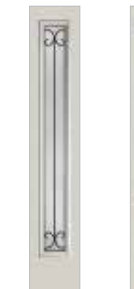

**TS572SL**  
 X 6  
 10" x 6'8" † ‡  
 12" x 6'8" † ‡  
 14" x 6'8" † ‡



**546SLHD**  
 X 6  
 12" x 6'8" † ‡  
 14" x 6'8" † ‡



**584SLHD**  
 X 6  
 12" x 6'8" † ‡  
 14" x 6'8" † ‡



**RSRT**  
 X  
 3'0" door + (2) 12" sidelites  
 Continuous Sill Systems Only

# Concorde™



**1028**  
 ◆ ■ ■ ■ 6  
 2'6" x 6'8" †  
 2'8" x 6'8" †  
 2'10" x 6'8" †  
 3'0" x 6'8" †  
 3'6" x 6'8" †



**967HD**  
 ◆ ■ ■ ■ 6  
 2'8" x 6'8"  
 2'10" x 6'8"  
 3'0" x 6'8"



**426HD**  
 ◆ ■ ■ ■ 6  
 2'6" x 6'8" †  
 2'8" x 6'8" †  
 2'10" x 6'8" †  
 3'0" x 6'8" †



**999HD**  
 ◆ ■ ■ ■ 6  
 2'8" x 6'8"  
 2'10" x 6'8"  
 3'0" x 6'8"



**1118HD**  
 ◆ ■ ■ ■ 6  
 2'8" x 6'8"  
 2'10" x 6'8"  
 3'0" x 6'8"



**450HD**  
 ◆ ■ ■ ■  
 2'8" x 6'8" †  
 2'10" x 6'8" †  
 3'0" x 6'8" †



**430HD**  
 ◆ ■ ■ ■  
 2'6" x 6'8" †  
 2'8" x 6'8" †  
 2'10" x 6'8" †  
 3'0" x 6'8" †



**453HD**  
 ◆ ■ ■ ■  
 2'8" x 6'8" †  
 2'10" x 6'8" †  
 3'0" x 6'8" †



**400HD**  
 ◆ ■ ■ ■  
 2'6" x 6'8" †  
 2'8" x 6'8" †  
 2'10" x 6'8" †  
 3'0" x 6'8" †  
 3'6" x 6'8" †



**1024HD**  
 ◆ ■ ■ ■  
 2'8" x 6'8"  
 2'10" x 6'8"  
 3'0" x 6'8"



**735HD**  
 ◆ ■ ■ ■  
 2'8" x 6'8" †  
 2'10" x 6'8" †  
 3'0" x 6'8" †



**454HD**  
 ◆ ■ ■ ■  
 2'8" x 6'8" †  
 2'10" x 6'8" †  
 3'0" x 6'8" †



**416SL**  
 ◆ ■ ■ ■ 6  
 10" x 6'8"  
 12" x 6'8" †  
 14" x 6'8" †



**967SLHD**  
 ◆ ■ ■ ■ 6  
 12" x 6'8"  
 14" x 6'8"



**977SLHD**  
 ◆ ■ ■ ■  
 12" x 6'8"  
 14" x 6'8"



**430SLHD**  
 ◆ ■ ■ ■ 6  
 12" x 6'8" †  
 14" x 6'8" †



**450SLHD**  
 ◆ ■ ■ ■  
 12" x 6'8" †  
 14" x 6'8" †



**CNHRT**  
 ◆ ■ ■ ■  
 3'0" door + (2) 12" sidelites  
 3'0" door + (2) 14" sidelites  
 Continuous Sill Systems Only



**CNRT**  
 ◆ ■ ■ ■  
 3'0" door + (2) 12" sidelites  
 3'0" door + (2) 14" sidelites  
 Continuous Sill Systems Only

## Key

- ◆ Black Nickel Caming (1D)
- ■ ■ Brushed Nickel Caming (1C)
- ❖ Brass Caming (1A)
- ✕ Wrought Iron (1W)
- 6 WBDR / HVHZ Options
- △ 6'6" Height Available
- † 7'0" Height Available

# Kensington™



**626**  
 ◆ ◆ 6  
 2'8" x 6'8" ‡  
 2'10" x 6'8" † ‡  
 3'0" x 6'8" † ‡  
 3'6" x 6'8" ‡



**03142HD**  
 ◆ ◆ 6  
 2'8" x 6'8"  
 2'10" x 6'8"  
 3'0" x 6'8"



**627HD**  
 ◆ ◆ 6  
 2'8" x 6'8" ‡  
 2'10" x 6'8" ‡  
 3'0" x 6'8" ‡



**631HD**  
 ◆ ◆ 6  
 2'8" x 6'8"  
 2'10" x 6'8"  
 3'0" x 6'8"



**1113HD**  
 ◆ ◆ 6  
 2'8" x 6'8"  
 2'10" x 6'8"  
 3'0" x 6'8"



**628HD**  
 ◆ ◆ 6  
 2'6" x 6'8" ‡  
 2'8" x 6'8" ‡  
 2'10" x 6'8" ‡  
 3'0" x 6'8" ‡



**630HD**  
 ◆ ◆  
 2'8" x 6'8"  
 2'10" x 6'8"  
 3'0" x 6'8"



**626SL**  
 ◆ ◆ 6  
 10" x 6'8"  
 12" x 6'8" ‡  
 14" x 6'8" ‡



**966SLHD**  
 ◆ ◆ 6  
 12" x 6'8"  
 14" x 6'8"



**628SLHD**  
 ◆ ◆ 6  
 12" x 6'8" ‡  
 14" x 6'8" ‡



**KNRT**  
 ◆ ◆  
 3'0" door + (2) 12" sidelites  
 3'0" door + (2) 14" sidelites  
 Continuous Sill Systems Only

# Axis™

Note: Product images show exterior side of door.



**1651HD**  
 ◆ 6  
 2'4" x 6'8" †  
 2'6" x 6'8" † ‡  
 2'8" x 6'8" † ‡  
 2'10" x 6'8" † ‡  
 3'0" x 6'8" † ‡  
 3'6" x 6'8" ‡



**1644HD**  
 ◆ 6  
 2'8" x 6'8"  
 2'10" x 6'8"  
 3'0" x 6'8"



**1660HD**  
 ◆ 6  
 2'6" x 6'8" ‡  
 2'8" x 6'8" ‡  
 2'10" x 6'8" ‡  
 3'0" x 6'8" ‡



**1657HD**  
 ◆ 6  
 2'8" x 6'8"  
 2'10" x 6'8"  
 3'0" x 6'8"



**1659HD**  
 ◆ 6  
 2'8" x 6'8"  
 2'10" x 6'8"  
 3'0" x 6'8"



**1662HD**  
 ◆  
 2'6" x 6'8" ‡  
 2'8" x 6'8" ‡  
 2'10" x 6'8" ‡  
 3'0" x 6'8" ‡



**1643HD**  
 ◆  
 2'8" x 6'8" ‡  
 2'10" x 6'8" ‡  
 3'0" x 6'8" ‡



**1651SL**  
 ◆ 6  
 10" x 6'8"  
 12" x 6'8" ‡  
 14" x 6'8" ‡





**1644SLHD**  
 ◆ 6  
 12" x 6'8" ‡  
 14" x 6'8"

**1657SLHD**  
 ◆ 6  
 12" x 6'8" ‡  
 14" x 6'8" ‡

**1643SLHD**  
 ◆ 6  
 12" x 6'8" ‡  
 14" x 6'8" ‡

**AXRT**  
 ◆  
 3'0" door + (2) 12" sidelites  
 Continuous Sill Systems Only

## Frosted Images®



**138**  
 6  
 2'6" x 6'8" △ ‡  
 2'8" x 6'8" △ ‡  
 2'10" x 6'8" △ ‡  
 3'0" x 6'8" △ ‡  
 3'6" x 6'8" ‡

**963HD**  
 6  
 2'8" x 6'8"  
 2'10" x 6'8"  
 3'0" x 6'8"

**206EHD**  
 6  
 2'8" x 6'8" ‡  
 2'10" x 6'8" ‡  
 3'0" x 6'8" ‡

**985HD**  
 6  
 2'8" x 6'8"  
 2'10" x 6'8"  
 3'0" x 6'8"

**1110HD**  
 6  
 2'8" x 6'8"  
 2'10" x 6'8"  
 3'0" x 6'8"

**250HD**  
 2'8" x 6'8" ‡  
 2'10" x 6'8" ‡  
 3'0" x 6'8" ‡

**289EHD**  
 2'6" x 6'8" ‡  
 2'8" x 6'8" ‡  
 2'10" x 6'8" ‡  
 3'0" x 6'8" ‡

**253HD**  
 2'8" x 6'8" ‡  
 2'10" x 6'8" ‡  
 3'0" x 6'8" ‡



**103HD**  
 2'6" x 6'8" ‡  
 2'8" x 6'8" ‡  
 2'10" x 6'8" ‡  
 3'0" x 6'8" ‡  
 3'6" x 6'8" ‡

**1021HD**  
 2'8" x 6'8"  
 2'10" x 6'8"  
 3'0" x 6'8"

**260HD**  
 2'8" x 6'8" ‡  
 2'10" x 6'8" ‡  
 3'0" x 6'8" ‡

**138SL**  
 6  
 10" x 6'8"  
 12" x 6'8" ‡  
 14" x 6'8" ‡

**289ESLHD**  
 6  
 12" x 6'8" ‡  
 14" x 6'8" ‡

**250SLHD**  
 12" x 6'8" ‡  
 14" x 6'8" ‡

### Key

- ◆ Black Nickel Caming (1D)
- Brushed Nickel Caming (1C)
- 6 WBDR / HVHZ Options
- △ 6'6" Height Available
- ‡ 7'0" Height Available

# Privacy & Textured Glass with Divided Lites

Note: For details on divided lite options, see pages 120–121.

|  |  |  |  |   |  |  |  |  |
|--|--|--|--|---|--|--|--|--|
|                                       |                                       |               |               |                |              |               |                   |                 |
| <b>128</b>                            | <b>108</b>                            | <b>961HD</b>  | <b>262HD</b>  | <b>1123HD</b>  | <b>982HD</b>  | <b>263HD</b>  | <b>6720HD_SL</b>  | <b>263SLHD</b>  |
| 2'6" x 6'8" $\Delta$ ‡<br>2'8" x 6'8" $\Delta$ ‡<br>2'10" x 6'8" $\Delta$ ‡<br>3'0" x 6'8" $\Delta$ ‡<br>3'6" x 6'8" ‡ | 2'6" x 6'8" $\Delta$ ‡<br>2'8" x 6'8" $\Delta$ ‡<br>2'10" x 6'8" $\Delta$ ‡<br>3'0" x 6'8" $\Delta$ ‡<br>3'6" x 6'8" ‡ | 2'8" x 6'8"<br>2'10" x 6'8"<br>3'0" x 6'8"   | 2'8" x 6'8" ‡<br>2'10" x 6'8" ‡<br>3'0" x 6'8" ‡   | 2'8" x 6'8"<br>2'10" x 6'8"<br>3'0" x 6'8"  | 2'8" x 6'8"<br>2'10" x 6'8"<br>3'0" x 6'8"   | 2'6" x 6'8" ‡<br>2'8" x 6'8" ‡<br>2'10" x 6'8" ‡<br>3'0" x 6'8" ‡                                | 12" x 6'8"<br>14" x 6'8"   | 12" x 6'8" ‡<br>14" x 6'8" ‡   |

# Privacy & Textured Glass

|  |  |  |  |  |  |
|--|--|--|--|--|--|
|    |                |                |                |                  |              |
| <b>118</b>    | <b>959HD</b>  | <b>206HD</b>  | <b>980HD</b>  | <b>1101_HD</b>  | <b>104</b>  |
| 2'4" x 6'8" $\Delta$ ‡<br>2'6" x 6'8" $\Delta$ ‡<br>2'8" x 6'8" $\Delta$ ‡<br>2'10" x 6'8" $\Delta$ ‡<br>3'0" x 6'8" $\Delta$ ‡<br>3'6" x 6'8" ‡ | 2'8" x 6'8"<br>2'10" x 6'8"<br>3'0" x 6'8"   | 2'8" x 6'8" ‡<br>2'10" x 6'8" ‡<br>3'0" x 6'8" ‡   | 2'8" x 6'8"<br>2'10" x 6'8"<br>3'0" x 6'8"   | 2'8" x 6'8"<br>2'10" x 6'8"<br>3'0" x 6'8"   | 2'8" x 6'8" ‡<br>2'10" x 6'8" ‡<br>3'0" x 6'8" ‡   |

|  |  |  |  |   |   |  |  |
|--|--|--|--|---|---|--|--|
|               |               |               |               |                |                 |                 |                 |
| <b>289HD</b>  | <b>708HD</b>  | <b>256HD</b>  | <b>296HD</b>  | <b>100_SL</b>  | <b>959HD_SL</b>  | <b>210SLHD</b>  | <b>296SLHD</b>  |
| 2'8" x 6'8" ‡<br>2'10" x 6'8" ‡<br>3'0" x 6'8" ‡   | 2'8" x 6'8" ‡<br>2'10" x 6'8" ‡<br>3'0" x 6'8" ‡   | 2'8" x 6'8" ‡<br>2'10" x 6'8" ‡<br>3'0" x 6'8" ‡   | 2'8" x 6'8" ‡<br>2'10" x 6'8" ‡<br>3'0" x 6'8" ‡   | 10" x 6'8"<br>12" x 6'8" ‡<br>14" x 6'8" ‡  | 12" x 6'8"<br>14" x 6'8"  | 12" x 6'8" ‡<br>14" x 6'8" ‡   | 12" x 6'8" ‡<br>14" x 6'8" ‡   |

### Privacy & Textured Glass Options

Add the code to the blank in the style number for the desired door and glass combination. For details on glass options, see page 206.

**XE** = Satin Etch Glass  
**XC** = Chord Glass

**XJ** = Chinchilla Glass  
**XR** = Rainglass

**XN** = Granite Glass

\*Features a gliding operation and sash locking system.

\*\*Not recommended for use behind storm doors or to be painted dark colors, if exposed to direct sunlight.

Note: See page 273 for important product details that may help with your purchase decision.

# Internal Blinds

Note: Product images show exterior side of door.



|  |  |  |   |  |  |   |  |   |
|--|--|--|---|--|--|---|--|---|
| <b>130</b><br>★<br>2'4" x 6'8" ⚠<br>2'6" x 6'8" ⚠ ‡<br>2'8" x 6'8" ⚠ ‡<br>2'10" x 6'8" ⚠ ‡<br>3'0" x 6'8" ⚠ ‡<br>3'6" x 6'8" ‡ | <b>5425</b><br>★<br>2'8" x 6'8"<br>2'10" x 6'8"<br>3'0" x 6'8" | <b>132HD</b><br>★<br>2'6" x 6'8" ‡<br>2'8" x 6'8" ‡<br>2'10" x 6'8" ‡<br>3'0" x 6'8" ‡ | <b>984HD</b><br>★<br>2'8" x 6'8"<br>2'10" x 6'8"<br>3'0" x 6'8" | <b>1121HD</b><br>★<br>2'8" x 6'8"<br>2'10" x 6'8"<br>3'0" x 6'8" | <b>131</b><br>★<br>2'6" x 6'8" ‡<br>2'8" x 6'8" ‡<br>2'10" x 6'8" ‡<br>3'0" x 6'8" ‡ | <b>130SL</b><br>★<br>10" x 6'8"<br>12" x 6'8" ‡<br>14" x 6'8" ‡ | <b>5425SL</b><br>★<br>12" x 6'8"<br>14" x 6'8" | <b>132SLHD</b><br>★<br>12" x 6'8" ‡<br>14" x 6'8" ‡ |
|--|--|--|---|--|--|---|--|---|

# Screen Vented Lites\*



|  |   |   |  |
|--|---|---|--|
| <b>243HD</b><br>2'8" x 6'8" ‡<br>2'10" x 6'8" ‡<br>3'0" x 6'8" ‡ | <b>1004HD</b><br>2'8" x 6'8"<br>2'10" x 6'8"<br>3'0" x 6'8" | <b>1102HD</b><br>2'8" x 6'8"<br>2'10" x 6'8"<br>3'0" x 6'8" | <b>137</b><br>2'8" x 6'8" ‡<br>2'10" x 6'8" ‡<br>3'0" x 6'8" ‡ |
|--|---|---|--|

# Clear Glass with Divided Lites

Note: For details on divided lite options, see pages 120–121.



|  |  |  |  |  |  |   |   |
|--|--|--|--|--|--|---|---|
| <b>1201</b><br>★◆<br>2'4" x 6'8" ⚠<br>2'6" x 6'8" ⚠ ‡<br>2'8" x 6'8" ⚠ ‡<br>2'10" x 6'8" ⚠ ‡<br>3'0" x 6'8" ⚠ ‡<br>3'6" x 6'8" ‡ | <b>1202</b><br>★◆<br>2'4" x 6'8" ⚠<br>2'6" x 6'8" ⚠ ‡<br>2'8" x 6'8" ⚠ ‡<br>2'10" x 6'8" ⚠ ‡<br>3'0" x 6'8" ⚠ ‡<br>3'6" x 6'8" ‡ | <b>1203</b><br>★◆<br>2'4" x 6'8" ⚠<br>2'6" x 6'8" ⚠ ‡<br>2'8" x 6'8" ⚠ ‡<br>2'10" x 6'8" ⚠ ‡<br>3'0" x 6'8" ⚠ ‡<br>3'6" x 6'8" ‡ | <b>128</b><br>★◆▶▶▶<br>2'4" x 6'8" ⚠<br>2'6" x 6'8" ⚠ ‡<br>2'8" x 6'8" ⚠ ‡<br>2'10" x 6'8" ⚠ ‡<br>3'0" x 6'8" ⚠ ‡<br>3'6" x 6'8" ‡ | <b>1200</b><br>★◆<br>2'4" x 6'8" ⚠<br>2'6" x 6'8" ⚠ ‡<br>2'8" x 6'8" ⚠ ‡<br>2'10" x 6'8" ⚠ ‡<br>3'0" x 6'8" ⚠ ‡<br>3'6" x 6'8" ‡ | <b>108</b><br>★◆▶▶▶<br>2'4" x 6'8" ⚠<br>2'6" x 6'8" ⚠ ‡<br>2'8" x 6'8" ⚠ ‡<br>2'10" x 6'8" ⚠ ‡<br>3'0" x 6'8" ⚠ ‡<br>3'6" x 6'8" ‡ | <b>2109HD</b><br>★◆<br>2'8" x 6'8"<br>2'10" x 6'8"<br>3'0" x 6'8" | <b>2110HD</b><br>★◆<br>2'8" x 6'8"<br>2'10" x 6'8"<br>3'0" x 6'8" |
|--|--|--|--|--|--|---|---|

Clear Glass with Divided Lites *Continues on next page.*

## Key

- ★ Low-E Glass (LE)
- ▶ Removable Wood Grilles (RG)
- ⚠ 6'6" Height Available
- ◆ Simulated Divided Lites (SDL)\*\*
- ◆ Fixed Grilles (FXG)
- ‡ 7'0" Height Available
- ◆ Flat or Contour, White or Color Grilles Between Glass (GBGF / GBGC)
- ◀ WBDR / HVHZ Options



Clear Glass with Divided Lites *Continued*



**2111HD**  
 \* ♦  
 2'8" x 6'8"  
 2'10" x 6'8"  
 3'0" x 6'8"



**961HD**  
 \* ♦ ♦ ♦ 6  
 2'8" x 6'8"  
 2'10" x 6'8"  
 3'0" x 6'8"



**6023HD**  
 \* >  
 2'8" x 6'8"  
 2'10" x 6'8"  
 3'0" x 6'8"



**1122HD**  
 \* >  
 2'8" x 6'8"  
 2'10" x 6'8"  
 3'0" x 6'8"



**262HD**  
 \* ♦ ♦ ♦ ♦ 6  
 2'6" x 6'8" ‡  
 2'8" x 6'8" ‡  
 2'10" x 6'8" ‡  
 3'0" x 6'8" ‡



**982HD**  
 \* ♦ ♦ ♦ ♦ 6  
 2'8" x 6'8"  
 2'10" x 6'8"  
 3'0" x 6'8"



**1123HD**  
 \* ♦ ♦ ♦ ♦ 6  
 2'8" x 6'8"  
 2'10" x 6'8"  
 3'0" x 6'8"



**151HD**  
 \* ♦  
 2'8" x 6'8" ‡  
 2'10" x 6'8" ‡  
 3'0" x 6'8" ‡



**263HD**  
 \* ♦ ♦ ♦ ♦  
 2'6" x 6'8" ‡  
 2'8" x 6'8" ‡  
 2'10" x 6'8" ‡  
 3'0" x 6'8" ‡



**154HD**  
 \* ♦  
 2'8" x 6'8" ‡  
 2'10" x 6'8" ‡  
 3'0" x 6'8" ‡



**115HD**  
 \* ♦  
 2'6" x 6'8" ‡  
 2'8" x 6'8" ‡  
 2'10" x 6'8" ‡  
 3'0" x 6'8" ‡



**752HD**  
 \* ♦ ♦ ♦  
 2'8" x 6'8" ‡  
 2'10" x 6'8" ‡  
 3'0" x 6'8" ‡



**255HD**  
 \* ♦ ♦  
 2'8" x 6'8" ‡  
 2'10" x 6'8" ‡  
 3'0" x 6'8" ‡



**236HD**  
 ♦  
 2'8" x 6'8" ‡  
 2'10" x 6'8" ‡  
 3'0" x 6'8" ‡



**237HD**  
 \* ♦  
 2'8" x 6'8" ‡  
 2'10" x 6'8" ‡  
 3'0" x 6'8" ‡  
 (Scalloped Lite Frame)



**1201SL**  
 \* ♦  
 10" x 6'8"  
 12" x 6'8" ‡  
 14" x 6'8" ‡



**1202SL**  
 \* ♦  
 10" x 6'8"  
 12" x 6'8" ‡  
 14" x 6'8" ‡



**1200SL**  
 \* ♦ ♦ 6  
 10" x 6'8"  
 12" x 6'8" ‡  
 14" x 6'8" ‡



**632SL**  
 \* ♦ ♦ ♦ >  
 6  
 10" x 6'8"  
 12" x 6'8" ‡  
 14" x 6'8" ‡



**1089SLHD**  
 \* ♦ ♦  
 12" x 6'8"  
 14" x 6'8"



**4572SLHD**  
 \* ♦ ♦ 6  
 12" x 6'8"  
 14" x 6'8"



**6720SLHD**  
 \* ♦ ♦ 6  
 12" x 6'8"  
 14" x 6'8"



**263SLHD**  
 \* ♦ ♦ ♦ >  
 6  
 12" x 6'8" ‡  
 14" x 6'8" ‡



**151SLHD**  
 \* ♦ ♦  
 12" x 6'8" ‡  
 14" x 6'8" ‡



**3000-2C**  
 \* ♦ ♦ ♦  
 2'0" x 6'8" ▽  
 2'4" x 6'8" △  
 2'6" x 6'8" △ ‡  
 2'8" x 6'8" △ ‡  
 2'10" x 6'8" △ ‡  
 3'0" x 6'8" △ ‡  
 3'6" x 6'8" ‡

**3000-3C**  
 \* ♦ ♦ ♦  
 2'0" x 6'8" ▽  
 2'4" x 6'8" △  
 2'6" x 6'8" △ ‡  
 2'8" x 6'8" △ ‡  
 2'10" x 6'8" △ ‡  
 3'0" x 6'8" △ ‡  
 3'6" x 6'8" ‡

\*2'0" frames do not have simulated divided lites option.

\*\*Not recommended for use behind storm doors or to be painted dark colors, if exposed to direct sunlight.

Note: See page 273 for important product details that may help with your purchase decision.



**3000-4C**  
 \* \* \* \*  
 2'0" x 6'8" ▽  
 2'4" x 6'8" ▲ ‡  
 2'6" x 6'8" ▲ ‡  
 2'8" x 6'8" ▲ ‡  
 2'10" x 6'8" ▲ ‡  
 3'0" x 6'8" ▲ ‡  
 3'6" x 6'8" ‡



**3000-6C**  
 \* \* \* \*  
 2'0" x 6'8" ▽  
 2'4" x 6'8" ▲ ‡  
 2'6" x 6'8" ▲ ‡  
 2'8" x 6'8" ▲ ‡  
 2'10" x 6'8" ▲ ‡  
 3'0" x 6'8" ▲ ‡  
 3'6" x 6'8" ‡



**6184SL**  
 \* \*  
 10" x 6'8"  
 12" x 6'8" ‡  
 14" x 6'8" ‡



**6185SL**  
 \* \*  
 10" x 6'8"  
 12" x 6'8" ‡  
 14" x 6'8" ‡



**6186SL**  
 \* \*  
 10" x 6'8"  
 12" x 6'8" ‡  
 14" x 6'8" ‡



**198**  
 \* \* \* \* 6  
 2'4" x 6'8" ▲ ‡  
 2'6" x 6'8" ▲ ‡  
 2'8" x 6'8" ▲ ‡  
 2'10" x 6'8" ▲ ‡  
 3'0" x 6'8" ▲ ‡  
 3'6" x 6'8" ‡



**1403HD**  
 \* \*  
 2'8" x 6'8"  
 2'10" x 6'8"  
 3'0" x 6'8"



**1408HD**  
 \* \*  
 2'6" x 6'8" ‡  
 2'8" x 6'8" ‡  
 2'10" x 6'8" ‡  
 3'0" x 6'8" ‡



**1405HD**  
 \* \*  
 2'8" x 6'8"  
 2'10" x 6'8"  
 3'0" x 6'8"



**1406HD**  
 \* \*  
 2'8" x 6'8"  
 2'10" x 6'8"  
 3'0" x 6'8"



**1411HD**  
 \* \*  
 2'6" x 6'8" ‡  
 2'8" x 6'8" ‡  
 2'10" x 6'8" ‡  
 3'0" x 6'8" ‡



**704HD**  
 \* \*  
 2'8" x 6'8" ‡  
 2'10" x 6'8" ‡  
 3'0" x 6'8" ‡

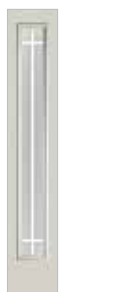

**198SL**  
 \* \*  
 10" x 6'8"  
 12" x 6'8" ‡  
 14" x 6'8" ‡



**1400SLHD**  
 \* \*  
 12" x 6'8"  
 14" x 6'8"



**1405SLHD**  
 \* \*  
 12" x 6'8" ‡  
 14" x 6'8" ‡



**19020T**  
 \*  
 3'0" door + (2) 12" sidelites  
 Continuous Sill Systems Only  
 3'0" door + (2) 14" sidelites  
 Continuous / Boxed Sill Systems  
 Grille Sticks Applied



**19220T**  
 \*  
 3'0" door + (2) 12" sidelites  
 3'0" door + (2) 14" sidelites  
 Continuous Sill Systems Only  
 Grille Sticks Applied



**19200T**  
 \*  
 3'0" Door Only  
 Grille Sticks Applied

## Clear Glass



**118**  
 \* \* \* \* 6  
 2'0" x 6'8" ▽  
 2'4" x 6'8" ▲ ‡  
 2'6" x 6'8" ▲ ‡  
 2'8" x 6'8" ▲ ‡  
 2'10" x 6'8" ▲ ‡  
 3'0" x 6'8" ▲ ‡  
 3'6" x 6'8" ‡



**959HD**  
 \* \* 6  
 2'8" x 6'8"  
 2'10" x 6'8"  
 3'0" x 6'8"



**206HD**  
 \* \* 6  
 2'6" x 6'8" ‡  
 2'8" x 6'8" ‡  
 2'10" x 6'8" ‡  
 3'0" x 6'8" ‡



**980HD**  
 \* \* 6  
 2'8" x 6'8"  
 2'10" x 6'8"  
 3'0" x 6'8"



**1101HD**  
 \* \* 6  
 2'8" x 6'8"  
 2'10" x 6'8"  
 3'0" x 6'8"



**104**  
 \* \* 6  
 2'6" x 6'8" ‡  
 2'8" x 6'8" ‡  
 2'10" x 6'8" ‡  
 3'0" x 6'8" ‡



**150HD**  
 \*  
 2'8" x 6'8" ‡  
 2'10" x 6'8" ‡  
 3'0" x 6'8" ‡



**289HD**  
 \*  
 2'6" x 6'8" ‡  
 2'8" x 6'8" ‡  
 2'10" x 6'8" ‡  
 3'0" x 6'8" ‡

Clear Glass Continues on next page.

### Key

☀ Low-E Glass (LE)

🐢 Turtle Glass

🗡 Simulated Divided Lites (SDL)\*, \*\*

◆ Flat White Grilles Between Glass (GBGFW)

◆ Flat or Contour, White or Color Grilles Between Glass (GBGF / GBGC)

➡ Removable Wood Grilles (RG)

◆ Fixed Grilles (FXG)

🌀 WBDR / HVHZ Options

▲ 6'6" Height Available

‡ 7'0" Height Available

▽ PVC Doorlite Frame\*\*

Clear Glass *Continued*



**153HD**  
\*  
2'8" x 6'8" ‡  
2'10" x 6'8" ‡  
3'0" x 6'8" ‡



**105**  
\*  
2'6" x 6'8" ‡  
2'8" x 6'8" ‡  
2'10" x 6'8" ‡  
3'0" x 6'8" ‡



**102**  
\*  
2'6" x 6'8" ‡  
2'8" x 6'8" ‡  
2'10" x 6'8" ‡  
3'0" x 6'8" ‡  
3'6" x 6'8" ‡



**1020HD**  
\*  
2'8" x 6'8" ‡  
2'10" x 6'8" ‡  
3'0" x 6'8" ‡



**708HD**  
\*  
2'8" x 6'8" ‡  
2'10" x 6'8" ‡  
3'0" x 6'8" ‡



**256HD**  
\*  
2'8" x 6'8" ‡  
2'10" x 6'8" ‡  
3'0" x 6'8" ‡



**296HD**  
\*  
2'8" x 6'8" ‡  
2'10" x 6'8" ‡  
3'0" x 6'8" ‡



**100SL**  
\* 6  
10" x 6'8" ‡  
12" x 6'8" ‡  
14" x 6'8" ‡



**959SLHD**  
\* 6  
12" x 6'8" ‡  
14" x 6'8" ‡



**970SLHD**  
\*  
12" x 6'8" ‡  
14" x 6'8" ‡



**210SLHD**  
\* 6  
12" x 6'8" ‡  
14" x 6'8" ‡



**150SLHD**  
\*  
12" x 6'8" ‡  
14" x 6'8" ‡



**296SLHD**  
\*  
12" x 6'8" ‡  
14" x 6'8" ‡



**19202T**  
\*  
3'0" door + (2) 12" sidelites  
Continuous Sill Systems Only  
3'0" door + (2) 14" sidelites  
Continuous / Boxed Sill Systems

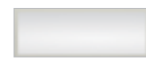

**19200T**  
\*  
3'0" Door Only



**19220T**  
\*  
3'0" door + (2) 12" sidelites  
3'0" door + (2) 14" sidelites  
Continuous Sill Systems Only



**19210T**  
\*  
12" & 14" Sidelite Only

## Solid Panel



**969HD**  
6  
2'8" x 6'8" ‡  
2'10" x 6'8" ‡  
3'0" x 6'8" ‡



**978HD**  
6  
2'8" x 6'8" ‡  
2'10" x 6'8" ‡  
3'0" x 6'8" ‡



**1005HD**  
6  
2'8" x 6'8" ‡  
2'10" x 6'8" ‡  
3'0" x 6'8" ‡



**205HD**  
6  
2'8" x 6'8" ‡  
2'10" x 6'8" ‡  
3'0" x 6'8" ‡



**203HD**  
6  
2'8" x 6'8" ‡  
2'10" x 6'8" ‡  
3'0" x 6'8" ‡



**210HD**  
6  
2'6" x 6'8" ‡  
2'8" x 6'8" ‡  
2'10" x 6'8" ‡  
3'0" x 6'8" ‡



**100**  
6  
2'0" x 6'8" ‡  
2'4" x 6'8" ‡  
2'6" x 6'8" ‡  
2'8" x 6'8" ‡  
2'10" x 6'8" ‡  
3'0" x 6'8" ‡  
3'6" x 6'8" ‡

\*Not recommended for use behind storm doors or to be painted dark colors, if exposed to direct sunlight.  
Note: See page 273 for important product details that may help with your purchase decision.





# Privacy & Textured Glass with Divided Lites

Note: For details on divided lite options, see pages 120–121.

|   |   |   |   |   |  |   |   |   |   |
|---|---|---|---|---|--|---|---|---|---|
|    |    |  |  |  |  |  |  |  |  |
| <b>TS128_</b><br>2'6" x 6'8"<br>2'8" x 6'8"<br>2'10" x 6'8" $\Delta$<br>3'0" x 6'8" | <b>TS108_</b><br>2'6" x 6'8"<br>2'8" x 6'8"<br>2'10" x 6'8" $\Delta$<br>3'0" x 6'8" | <b>TS262_</b><br>2'8" x 6'8"<br>2'10" x 6'8"<br>3'0" x 6'8"                       | <b>8321_</b><br>2'8" x 8'0"<br>2'10" x 8'0"<br>3'0" x 8'0"                        | <b>TS263_</b><br>2'6" x 6'8"<br>2'8" x 6'8"<br>2'10" x 6'8"<br>3'0" x 6'8"        | <b>6184_SL</b><br>10" x 6'8"<br>12" x 6'8" ‡<br>14" x 6'8" ‡                       | <b>6185_SL</b><br>10" x 6'8"<br>12" x 6'8" ‡<br>14" x 6'8" ‡                        | <b>6186_SL</b><br>10" x 6'8"<br>12" x 6'8" ‡<br>14" x 6'8" ‡                        | <b>632_SL</b><br>10" x 6'8"<br>12" x 6'8" ‡<br>14" x 6'8" ‡                         | <b>TS263_SL</b><br>12" x 6'8"<br>14" x 6'8"   |

# Privacy & Textured Glass

|  |  |  |  |   |  |  |  |   |
|--|--|--|--|---|--|--|--|---|
|                               |  |  |  |  |  |  |  |  |
| <b>TS118_</b><br>6<br>2'4" x 6'8" $\Delta$<br>2'6" x 6'8"<br>2'8" x 6'8"<br>2'10" x 6'8" $\Delta$<br>3'0" x 6'8" | <b>818_</b><br>6<br>2'6" x 8'0"<br>2'8" x 8'0"<br>2'10" x 8'0"<br>3'0" x 8'0"      | <b>TS206_</b><br>6<br>2'8" x 6'8"<br>2'10" x 6'8"<br>3'0" x 6'8"                   | <b>8206_</b><br>6<br>2'8" x 8'0"<br>2'10" x 8'0"<br>3'0" x 8'0"                    | <b>TS104_</b><br>6<br>2'8" x 6'8"<br>2'10" x 6'8" $\Delta$<br>3'0" x 6'8"           | <b>TS289_</b><br>2'6" x 6'8"<br>2'8" x 6'8"<br>2'10" x 6'8"<br>3'0" x 6'8"           | <b>TS708_</b><br>2'8" x 6'8"<br>2'10" x 6'8"<br>3'0" x 6'8"                          | <b>8708_</b><br>2'8" x 8'0"<br>2'10" x 8'0"<br>3'0" x 8'0"                           | <b>TS256_</b><br>2'8" x 6'8"<br>2'10" x 6'8"<br>3'0" x 6'8"                           |

Privacy & Textured Glass *Continues on next page.*

## Privacy & Textured Glass Options

Add the code to the blank in the style number for the desired door and glass combination. For details on glass options, see page 206.

XE = Satin Etch Glass    XJ = Chinchilla Glass    XN = Granite Glass  
XC = Chord Glass    XR = Rainglass

## Key

-  Low-E Glass (LE)
-  Simulated Divided Lites (SDL)\*
-  WBDR / HVHZ Options
- $\Delta$  6'6" Height Available
- ‡ 7'0" Height Available

**Privacy & Textured Glass** *Continued*



|   |  |   |   |   |   |
|---|--|---|---|---|---|
| <b>TS296</b><br>2'6" x 6'8"<br>2'8" x 6'8"<br>2'10" x 6'8"<br>3'0" x 6'8" | <b>896</b><br>2'8" x 8'0"<br>2'10" x 8'0"<br>3'0" x 8'0" | <b>100_SL</b><br>10" x 6'8"<br>12" x 6'8" ‡<br>14" x 6'8" ‡ | <b>818_SL</b><br>12" x 8'0"<br>14" x 8'0" | <b>TS210_SL</b><br>12" x 6'8"<br>14" x 6'8" | <b>TS296_SL</b><br>12" x 6'8"<br>14" x 6'8" |
|---|--|---|---|---|---|

**Internal Blinds**

Note: Product images show exterior side of door.



|   |  |  |  |  |   |   |   |
|---|--|--|--|--|---|---|---|
| <b>TS130</b><br>★<br>2'4" x 6'8" Δ<br>2'6" x 6'8"<br>2'8" x 6'8"<br>2'10" x 6'8" Δ<br>3'0" x 6'8" | <b>829</b><br>★<br>2'6" x 8'0"<br>2'8" x 8'0"<br>2'10" x 8'0"<br>3'0" x 8'0" | <b>TS132</b><br>★<br>2'6" x 6'8"<br>2'8" x 6'8"<br>2'10" x 6'8"<br>3'0" x 6'8" | <b>8132</b><br>★<br>2'8" x 8'0"<br>2'10" x 8'0"<br>3'0" x 8'0" | <b>TS131</b><br>★<br>2'6" x 6'8"<br>2'8" x 6'8"<br>2'10" x 6'8" Δ<br>3'0" x 6'8" | <b>130SL</b><br>★<br>10" x 6'8"<br>12" x 6'8" ‡<br>14" x 6'8" ‡ | <b>829SL</b><br>★<br>12" x 8'0"<br>14" x 8'0" | <b>TS132SL</b><br>★<br>12" x 6'8"<br>14" x 6'8" |
|---|--|--|--|--|---|---|---|

**Screen Vented Lites\***

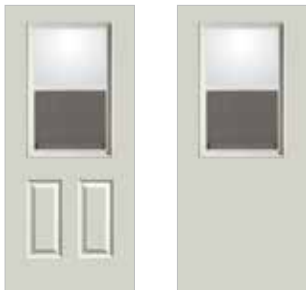

|  |  |
|--|--|
| <b>TS243</b><br>2'8" x 6'8"<br>2'10" x 6'8"<br>3'0" x 6'8" | <b>TS137</b><br>2'8" x 6'8"<br>2'10" x 6'8" Δ<br>3'0" x 6'8" |
|--|--|

**Privacy & Textured Glass Options**

Add the code to the blank in the style number for the desired door and glass combination. For details on glass options, see page 206.

|                              |                              |                           |
|------------------------------|------------------------------|---------------------------|
| <b>XE = Satin Etch Glass</b> | <b>XJ = Chinchilla Glass</b> | <b>XN = Granite Glass</b> |
| <b>XC = Chord Glass</b>      | <b>XR = Rainglass</b>        |                           |

\*Features a gliding operation and sash locking system.  
 \*\*Not recommended for use behind storm doors or to be painted dark colors, if exposed to direct sunlight.  
 Note: See page 273 for important product details that may help with your purchase decision.

# Clear Glass with Divided Lites

Note: For details on divided lite options, see pages 120-121.

|  |  |  |   |  |   |  |  |   |   |
|--|--|--|---|--|---|--|--|---|---|
|                     |                     |                     |                                |                                 |                               |                                     |         |   |   |
| <b>TS1201</b><br>★ ◆<br>2'4" x 6'8" ▲<br>2'6" x 6'8"<br>2'8" x 6'8"<br>2'10" x 6'8" ▲<br>3'0" x 6'8" | <b>TS1202</b><br>★ ◆<br>2'4" x 6'8" ▲<br>2'6" x 6'8"<br>2'8" x 6'8"<br>2'10" x 6'8" ▲<br>3'0" x 6'8" | <b>TS1203</b><br>★ ◆<br>2'4" x 6'8" ▲<br>2'6" x 6'8"<br>2'8" x 6'8"<br>2'10" x 6'8" ▲<br>3'0" x 6'8" | <b>TS128</b><br>★ ◆ ◆ ◆ ◆ ◆ ◆ ◆<br>2'4" x 6'8" ▲<br>2'6" x 6'8"<br>2'8" x 6'8"<br>2'10" x 6'8" ▲<br>3'0" x 6'8" | <b>TS1200</b><br>★ ◆ ◆ ◆ ◆ ◆ ◆ ◆<br>2'4" x 6'8" ▲<br>2'6" x 6'8"<br>2'8" x 6'8"<br>2'10" x 6'8" ▲<br>3'0" x 6'8" | <b>TS108</b><br>★ ◆ ◆ ◆ ◆ ◆ ◆ ◆<br>2'4" x 6'8" ▲<br>2'6" x 6'8"<br>2'8" x 6'8"<br>2'10" x 6'8" ▲<br>3'0" x 6'8" | <b>828</b><br>★ ◆ ◆ ◆ ◆ ◆ ◆ ◆<br>2'6" x 8'0"<br>2'8" x 8'0"<br>2'10" x 8'0"<br>3'0" x 8'0"                             | <b>808</b><br>★ ◆ ◆ ◆ ◆ ◆ ◆ ◆<br>2'6" x 8'0"<br>2'8" x 8'0"<br>2'10" x 8'0"<br>3'0" x 8'0" |   |   |
|                    |                    |                    |                               |                                |                              |                                    |        |   |   |
| <b>8322</b><br>★ ◆<br>2'8" x 8'0"<br>2'10" x 8'0"<br>3'0" x 8'0"                                     | <b>8323</b><br>★ ◆ ◆ ◆ ◆ ◆ ◆ ◆<br>2'8" x 8'0"<br>2'10" x 8'0"<br>3'0" x 8'0"                         | <b>8324</b><br>★ ◆ ◆ ◆ ◆ ◆ ◆ ◆<br>2'8" x 8'0"<br>2'10" x 8'0"<br>3'0" x 8'0"                         | <b>TS262</b><br>★ ◆ ◆ ◆ ◆ ◆ ◆ ◆<br>2'6" x 6'8"<br>2'8" x 6'8"<br>2'10" x 6'8"<br>3'0" x 6'8"                    | <b>8321</b><br>★ ◆ ◆ ◆ ◆ ◆ ◆ ◆<br>2'8" x 8'0"<br>2'10" x 8'0"<br>3'0" x 8'0"                                     | <b>TS151</b><br>★ ◆ ◆ ◆ ◆ ◆ ◆ ◆<br>2'8" x 6'8"<br>2'10" x 6'8"<br>3'0" x 6'8"                                   | <b>TS263</b><br>★ ◆ ◆ ◆ ◆ ◆ ◆ ◆<br>2'6" x 6'8"<br>2'8" x 6'8"<br>2'10" x 6'8"<br>3'0" x 6'8"                           | <b>TS154</b><br>★ ◆ ◆ ◆ ◆ ◆ ◆ ◆<br>2'8" x 6'8"<br>2'10" x 6'8"<br>3'0" x 6'8"              |   |   |
|                   |                   |                   |                              |                               |                              |                                    |       |  |  |
| <b>TS115</b><br>★ ◆ ◆ ◆ ◆ ◆ ◆ ◆<br>2'6" x 6'8"<br>2'8" x 6'8"<br>2'10" x 6'8" ▲<br>3'0" x 6'8"       | <b>TS752</b><br>★ ◆ ◆ ◆ ◆ ◆ ◆ ◆<br>2'8" x 6'8"<br>2'10" x 6'8"<br>3'0" x 6'8"                        | <b>8752</b><br>★ ◆ ◆ ◆ ◆ ◆ ◆ ◆<br>2'8" x 8'0"<br>2'10" x 8'0"<br>3'0" x 8'0"                         | <b>TS255</b><br>★ ◆ ◆ ◆ ◆ ◆ ◆ ◆<br>2'8" x 6'8"<br>2'10" x 6'8"<br>3'0" x 6'8"                                   | <b>TS236</b><br>◆ ◆ ◆ ◆ ◆ ◆ ◆ ◆<br>2'8" x 6'8"<br>2'10" x 6'8"<br>3'0" x 6'8"                                    | <b>8317</b><br>◆ ◆ ◆ ◆ ◆ ◆ ◆ ◆<br>2'8" x 8'0"<br>2'10" x 8'0"<br>3'0" x 8'0"                                    | <b>TS237</b><br>★ ◆ ◆ ◆ ◆ ◆ ◆ ◆<br>2'8" x 6'8"<br>2'10" x 6'8"<br>3'0" x 6'8"<br><small>(Scalloped Lite Frame)</small> | <b>1201SL</b><br>★ ◆ ◆ ◆ ◆ ◆ ◆ ◆<br>10" x 6'8"<br>12" x 6'8" ‡<br>14" x 6'8" ‡             | <b>1202SL</b><br>★ ◆ ◆ ◆ ◆ ◆ ◆ ◆<br>10" x 6'8"<br>12" x 6'8" ‡<br>14" x 6'8" ‡        | <b>1200SL</b><br>★ ◆ ◆ ◆ ◆ ◆ ◆ ◆<br>10" x 6'8"<br>12" x 6'8" ‡<br>14" x 6'8" ‡        |

Clear Glass with Divided Lites *Continues on next page.*

**Key**

|   |                               |                         |
|---|-------------------------------|-------------------------|
| ★ Low-E Glass (LE)  | ◆ Removable Wood Grilles (RG) | ▲ 6'6" Height Available |
| ◆ Simulated Divided Lites (SDL)**                                     | ◆ Fixed Grilles (FXG)         | ‡ 7'0" Height Available |
| ◆ Flat or Contour, White or Color Grilles Between Glass (GBGF / GBGC) | ◆ WBDP / HVHZ Options         |                         |

## Clear Glass with Divided Lites *Continued*



**632SL**  
  
10" x 6'8"  
 12" x 6'8" ‡  
 14" x 6'8" ‡

**828SL**  
  
12" x 8'0"  
 14" x 8'0"

**TS263SL**  
  
12" x 6'8"  
 14" x 6'8"

**TS151SL**  
  
12" x 6'8"  
 14" x 6'8"

**TS3000-2C**  
  
2'0" x 6'8" ▽  
 2'4" x 6'8" △  
 2'6" x 6'8"  
 2'8" x 6'8"  
 2'10" x 6'8" △  
 3'0" x 6'8"

**83000-2C**  
  
2'0" x 8'0" ▽  
 2'6" x 8'0"  
 2'8" x 8'0"  
 2'10" x 8'0"  
 3'0" x 8'0"

**TS3000-3C**  
  
2'0" x 6'8" ▽  
 2'4" x 6'8" △  
 2'6" x 6'8"  
 2'8" x 6'8"  
 2'10" x 6'8" △  
 3'0" x 6'8"

**83000-3C**  
  
2'0" x 8'0" ▽  
 2'6" x 8'0"  
 2'8" x 8'0"  
 2'10" x 8'0"  
 3'0" x 8'0"

**TS3000-4C**  
  
2'0" x 6'8" ▽  
 2'4" x 6'8" △  
 2'6" x 6'8"  
 2'8" x 6'8"  
 2'10" x 6'8" △  
 3'0" x 6'8"

**83000-4C**  
  
2'0" x 8'0" ▽  
 2'6" x 8'0"  
 2'8" x 8'0"  
 2'10" x 8'0"  
 3'0" x 8'0"

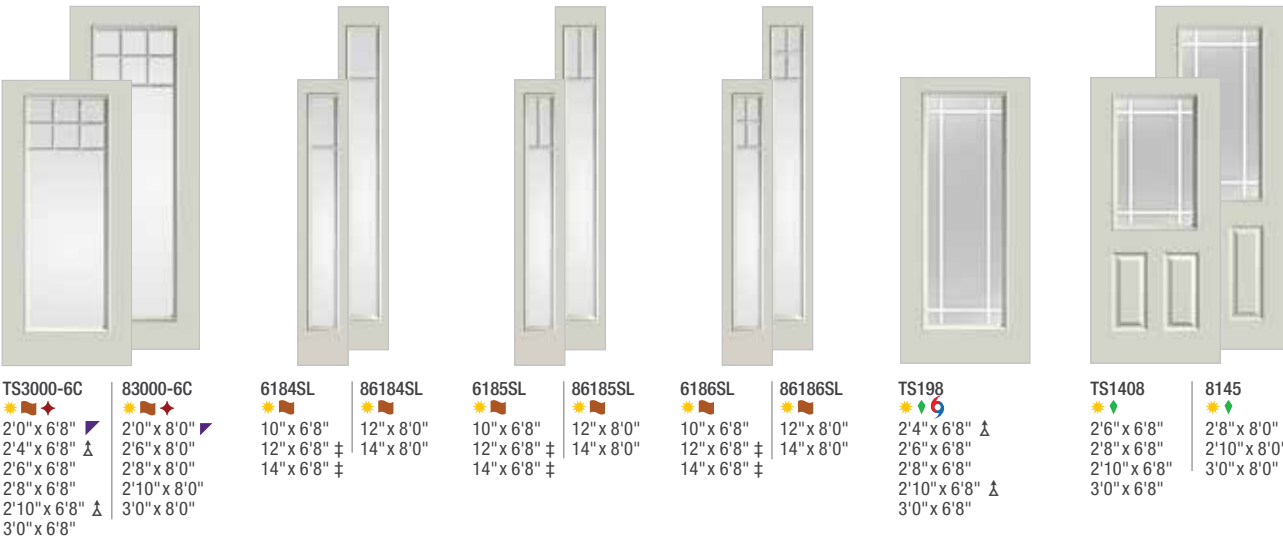

**TS3000-6C**  
  
2'0" x 6'8" ▽  
 2'4" x 6'8" △  
 2'6" x 6'8"  
 2'8" x 6'8"  
 2'10" x 6'8" △  
 3'0" x 6'8"

**83000-6C**  
  
2'0" x 8'0" ▽  
 2'6" x 8'0"  
 2'8" x 8'0"  
 2'10" x 8'0"  
 3'0" x 8'0"

**6184SL**  
  
10" x 6'8"  
 12" x 6'8" ‡  
 14" x 6'8" ‡

**86184SL**  
  
12" x 8'0"  
 14" x 8'0"

**6185SL**  
  
10" x 6'8"  
 12" x 6'8" ‡  
 14" x 6'8" ‡

**86185SL**  
  
12" x 8'0"  
 14" x 8'0"

**6186SL**  
  
10" x 6'8"  
 12" x 6'8" ‡  
 14" x 6'8" ‡

**86186SL**  
  
12" x 8'0"  
 14" x 8'0"

**TS198**  
  
2'4" x 6'8" △  
 2'6" x 6'8"  
 2'8" x 6'8"  
 2'10" x 6'8" △  
 3'0" x 6'8"

**TS1408**  
  
2'6" x 6'8"  
 2'8" x 6'8"  
 2'10" x 6'8"  
 3'0" x 6'8"

**8145**  
  
2'8" x 8'0"  
 2'10" x 8'0"  
 3'0" x 8'0"



**TS1411**  
  
2'6" x 6'8"  
 2'8" x 6'8"  
 2'10" x 6'8"  
 3'0" x 6'8"

**TS704**  
  
2'8" x 6'8"  
 2'10" x 6'8"  
 3'0" x 6'8"

**8704**  
  
2'8" x 8'0"  
 2'10" x 8'0"  
 3'0" x 8'0"

**198SL**  
  
10" x 6'8"  
 12" x 6'8" ‡  
 14" x 6'8" ‡

**TS1405SL**  
  
12" x 6'8"  
 14" x 6'8"

\*2'0" frames do not have simulated divided lites option.  
 \*\*Not recommended for use behind storm doors or to be painted dark colors, if exposed to direct sunlight.  
 Note: See page 273 for important product details that may help with your purchase decision.



# Clear Glass



|  |   |  |  |  |   |  |   |  |
|--|---|--|--|--|---|--|---|--|
| <b>TS118</b><br>★ 6<br>2'0" x 6'8" ▽<br>2'4" x 6'8" ▲<br>2'6" x 6'8" ▽<br>2'8" x 6'8" ▽<br>2'10" x 6'8" ▲<br>3'0" x 6'8" ▽ | <b>818</b><br>★ 6<br>2'0" x 8'0" ▽<br>2'6" x 8'0" ▽<br>2'8" x 8'0" ▽<br>2'10" x 8'0" ▽<br>3'0" x 8'0" ▽ | <b>TS206</b><br>★ 6<br>2'6" x 6'8" ▽<br>2'8" x 6'8" ▽<br>2'10" x 6'8" ▽<br>3'0" x 6'8" ▽ | <b>8206</b><br>★ 6<br>2'8" x 8'0" ▽<br>2'10" x 8'0" ▽<br>3'0" x 8'0" ▽ | <b>TS104</b><br>★ 6<br>2'6" x 6'8" ▽<br>2'8" x 6'8" ▽<br>2'10" x 6'8" ▲<br>3'0" x 6'8" ▽ | <b>TS150</b><br>★<br>2'8" x 6'8" ▽<br>2'10" x 6'8" ▽<br>3'0" x 6'8" ▽ | <b>TS289</b><br>★<br>2'6" x 6'8" ▽<br>2'8" x 6'8" ▽<br>2'10" x 6'8" ▽<br>3'0" x 6'8" ▽ | <b>TS153</b><br>★<br>2'8" x 6'8" ▽<br>2'10" x 6'8" ▽<br>3'0" x 6'8" ▽ | <b>TS105</b><br>★<br>2'6" x 6'8" ▽<br>2'8" x 6'8" ▽<br>2'10" x 6'8" ▲<br>3'0" x 6'8" ▽ |
|--|---|--|--|--|---|--|---|--|

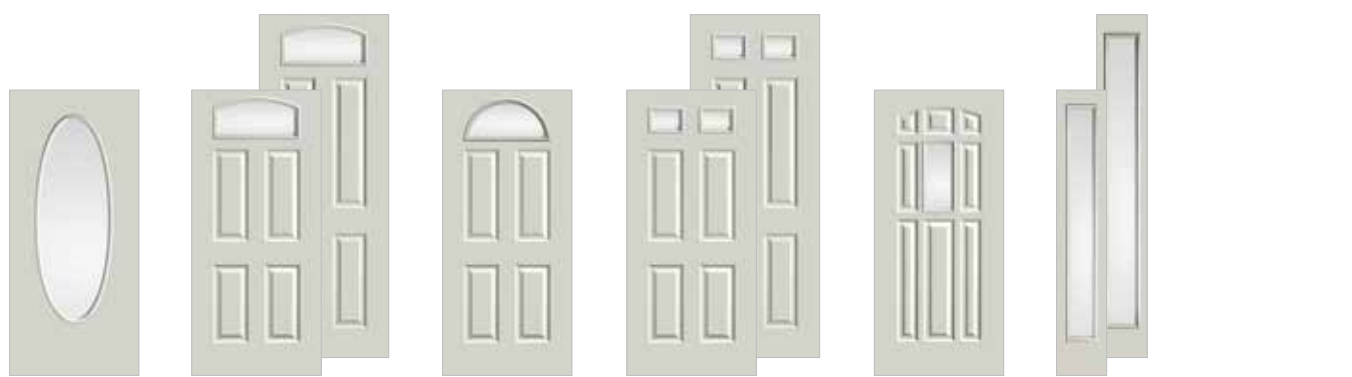

|  |   |  |   |  |   |   |   |   |
|--|---|--|---|--|---|---|---|---|
| <b>TS102</b><br>★<br>2'6" x 6'8" ▽<br>2'8" x 6'8" ▽<br>2'10" x 6'8" ▲<br>3'0" x 6'8" ▽ | <b>TS708</b><br>★<br>2'8" x 6'8" ▽<br>2'10" x 6'8" ▽<br>3'0" x 6'8" ▽ | <b>8708</b><br>★<br>2'8" x 8'0" ▽<br>2'10" x 8'0" ▽<br>3'0" x 8'0" ▽ | <b>TS256</b><br>★<br>2'8" x 6'8" ▽<br>2'10" x 6'8" ▽<br>3'0" x 6'8" ▽ | <b>TS296</b><br>★<br>2'6" x 6'8" ▽<br>2'8" x 6'8" ▽<br>2'10" x 6'8" ▽<br>3'0" x 6'8" ▽ | <b>896</b><br>★<br>2'8" x 8'0" ▽<br>2'10" x 8'0" ▽<br>3'0" x 8'0" ▽ | <b>TS291</b><br>★<br>2'8" x 6'8" ▽<br>2'10" x 6'8" ▽<br>3'0" x 6'8" ▽ | <b>100SL</b><br>★ 6<br>10" x 6'8" ▽<br>12" x 6'8" ‡<br>14" x 6'8" ‡ | <b>818SL</b><br>★ 6<br>12" x 8'0" ▽<br>14" x 8'0" ▽ |
|--|---|--|---|--|---|---|---|---|

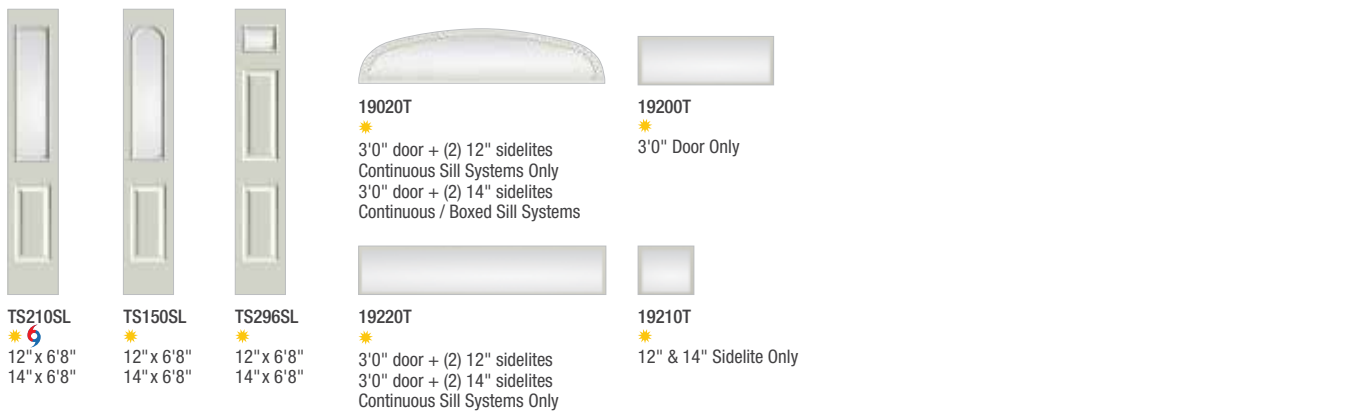

|   |   |   |   |                                      |   |
|---|---|---|---|--------------------------------------|---|
| <b>TS210SL</b><br>★ 6<br>12" x 6'8" ▽<br>14" x 6'8" ▽ | <b>TS150SL</b><br>★<br>12" x 6'8" ▽<br>14" x 6'8" ▽ | <b>TS296SL</b><br>★<br>12" x 6'8" ▽<br>14" x 6'8" ▽ | <b>19020T</b><br>★<br>3'0" door + (2) 12" sidelites<br>Continuous Sill Systems Only<br>3'0" door + (2) 14" sidelites<br>Continuous / Boxed Sill Systems | <b>19200T</b><br>★<br>3'0" Door Only | <b>19210T</b><br>★<br>12" & 14" Sidelite Only |
|---|---|---|---|--------------------------------------|---|

## Key

- ★ Low-E Glass (LE)
- 🐢 Turtle Glass
- 🏠 Simulated Divided Lites (SDL)\*,\*\*
- ◆ Flat White Grilles Between Glass Only (GBGFW)
- ◇ Flat or Contour, White or Color Grilles Between Glass (GBGF / GBGC)
- Removable Wood Grilles (RG)
- ◆ Fixed Grilles (FXG)
- 6 WBDR / HVHZ Options
- ▲ 6'6" Height Available
- ‡ 7'0" Height Available
- ▽ PVC Doorlite Frame\*\*

# Solid Panel



**TS290**  
 2'8" x 6'8"  
 2'10" x 6'8"  
 3'0" x 6'8"



**TS214**  
 2'8" x 6'8"  
 2'10" x 6'8"  
 3'0" x 6'8"



**TS210**  
 2'6" x 6'8"  
 2'8" x 6'8"  
 2'10" x 6'8"  
 3'0" x 6'8"

**810**  
 2'6" x 8'0"  
 2'8" x 8'0"  
 2'10" x 8'0"  
 3'0" x 8'0"

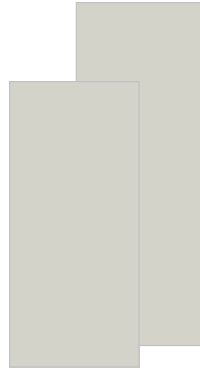

**TS100**  
 2'0" x 6'8"  
 2'4" x 6'8" Δ  
 2'6" x 6'8"  
 2'8" x 6'8"  
 2'10" x 6'8" Δ  
 3'0" x 6'8"

**800**  
 2'0" x 8'0"  
 2'4" x 8'0"  
 2'6" x 8'0"  
 2'8" x 8'0"  
 2'10" x 8'0"  
 3'0" x 8'0"



Note: See page 273 for important product details that may help with your purchase decision.  
 Bottom: Traditions, Sedona Art Glass, Door – TS211-A, Sidelites – 139SL-A

**Key**  
 6 WBD / HVHZ Options  
 Δ 6'6" Height Available

# Fire Doors

Classic-Craft®, Fiber-Classic®, Smooth-Star® & Steel

The phrase  
“safety first” is more  
than just a saying. It’s  
our standard.

From smooth to wood-grained, we have products to meet most national and local code requirements for house-to-garage, multi-family residential and hotel / motel unit entries.\*

227

• Safety first.

## Adjusta-Fit® 2 Frame

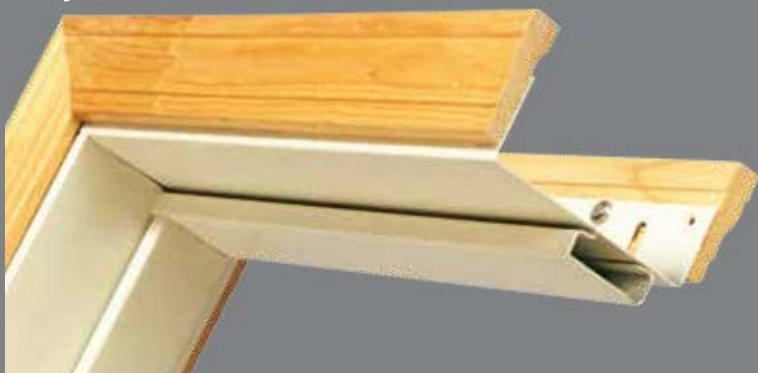

Using the right frame is critical in any top-quality door installation, and never more so than with Fire-rated products. Therma-Tru Adjusta-Fit 2 frame technology helps ensure an optimum fit and long-lasting performance. The frames are constructed with a commercial-grade, 18-gauge base frame; galvanized steel and factory-coated paint finish; and an all-aluminum, thermally broken threshold. These features make them ideal for interior and exterior applications, including corridor openings and outside unit entries.

### Therma-Tru® Adjusta-Fit 2 frames also feature these key benefits:

- 90-Minute positive-pressure Fire-rating, third-party certified by Intertek, Warnock-Hersey.
- Standard 4-7/8" ANSI 115.1, or 2-3/4" T-lip strike prep option.
- Choice of standard, public access or no-sill options.
- Minimum 22-gauge closure with 1" of adjustability, suitable for walls from 4"-9-1/2" deep.

\*To confirm fire door requirements in your jurisdiction, always check with your local building code authority. Note: To see the full results of third-party Intertek, Warnock-Hersey testing, visit [www.thermatru.com/performance](http://www.thermatru.com/performance) data.

## 90-Minute Fire-Rated Steel Edge

Therma-Tru's TR 12-24 Steel Edge 90-Minute Fire-rated doors and door systems provide outstanding protection. Constructed with 24-gauge steel edges and tested to withstand at least 90 minutes of fire exposure at temperatures that reach more than 1,700 degrees Fahrenheit, the doors are perfect for multi-family living and house-to-garage projects. Available in a variety of door styles, sizes and lock preparations, the units are suitable for a minimum 4" wall depth or greater. Therma-Tru also offers all the necessary components – frame, weatherstrip, bottom sweep and sill – to complete a 90-Minute Fire-rated door system.

**6** WBDR / HVHZ Options: Look for this icon to find door styles that can be configured for WBDR or HVHZ in an Adjusta-Fit. 2 frame.\*



SE100  
**6**  
 2'0" x 6'8"  
 2'4" x 6'8"  
 2'6" x 6'8"  
 2'8" x 6'8" ‡  
 2'10" x 6'8"  
 3'0" x 6'8" ‡  
 3'6" x 6'8" ‡



SE210HD  
**6**  
 2'6" x 6'8"  
 2'8" x 6'8" ‡  
 2'10" x 6'8"  
 3'0" x 6'8" ‡



SE514  
**6**  
 2'8" x 6'8" ‡  
 2'10" x 6'8"  
 3'0" x 6'8" ‡



SE978HD  
**6**  
 2'8" x 6'8" ‡  
 2'10" x 6'8"  
 3'0" x 6'8" ‡



SE969HD  
**6**  
 2'8" x 6'8"  
 2'10" x 6'8"  
 3'0" x 6'8"



SE1005HD  
**6**  
 2'8" x 6'8"  
 2'10" x 6'8"  
 3'0" x 6'8"

## 20-Minute Fire-Rated Wood Edge

Therma-Tru offers an industry-leading selection of fiberglass 20-Minute Fire-rated doors. Most of our solid-panel fiberglass wood-edge doors can be ordered as 20-Minute Fire-rated product, featuring a proprietary cement-based core. Solid-panel steel wood-edge doors in select sizes can be ordered with the 20-Minute Fire-rated label. The doors are tested to withstand a minimum of 20 minutes of fire exposure at temperatures that reach more than 1,400 degrees Fahrenheit, and are certified and approved for use with mortise locks.

**6** WBDR / HVHZ Options: Look for this icon to find door styles that can be configured for WBDR or HVHZ in a Therma-Tru-specified wood frame.\*

### Classic-Craft. Mahogany Collection™



CCMF890  
 3'0" x 8'0"



CCMF060  
 3'0" x 6'8"



CCMF701  
 3'0" x 6'8"

\*Please verify that there is a Therma-Tru product approval for the configuration before buying.

Note: To see the full results of third-party Intertek, Warnock-Hersey testing, visit [www.thermatru.com/performance](http://www.thermatru.com/performance). See your Therma-Tru seller or visit [www.thermatru.com](http://www.thermatru.com) for details on limited warranties and exclusions. See page 273 for important product details that may help with your purchase decision.



## Rustic Collection™



CCRF205  
3'0" x 6'8"

CCRF8205  
3'0" x 8'0"

CCRF205A  
3'0" x 6'8"

CCRF8205A  
3'0" x 8'0"

CCRF8225  
3'0" x 8'0"

CCRF8225R  
3'0" x 8'0"

CCRF8005  
3'0" x 8'0"

CCRF8005A  
3'0" x 8'0"

CCRF040  
3'0" x 6'8"

CCRF8040  
3'0" x 8'0"



CCRF040F  
3'0" x 6'8"

CCRF8040F  
3'0" x 8'0"

CCRF8222  
3'0" x 8'0"

CCRF200  
3'0" x 6'8"

CCRF8200  
3'0" x 8'0"

CCRF200A  
3'0" x 6'8"

CCRF8200A  
3'0" x 8'0"

CCRF8220  
3'0" x 8'0"

CCRF8220R  
3'0" x 8'0"

## Oak Collection™



CCF91  
3'0" x 6'8"

CCF831  
3'0" x 8'0"

CCF810  
3'0" x 8'0"

CCF060  
2'8" x 6'8"  
3'0" x 6'8"

## Canvas Collection.



CCVF400  
3'0" x 6'8"

CCVF205  
3'0" x 6'8"

CCVF8205  
3'0" x 8'0"

CCVF205A  
3'0" x 6'8"

CCVF8205A  
3'0" x 8'0"

Classic-Craft *Continues on next page.*

### Key

- No Stile Lines
- 6 WBDR / HVHZ Options
- ‡ 7'0" Height Available

Classic-Craft. *Continued*



|                               |                                |   |                               |   |                               |                               |
|-------------------------------|--------------------------------|---|-------------------------------|---|-------------------------------|-------------------------------|
| <b>CCVF455</b><br>3'0" x 6'8" | <b>CCVF455A</b><br>3'0" x 6'8" | <b>CCVF220</b>   <b>CCVF8220</b><br>3'0" x 6'8"   3'0" x 8'0" | <b>CCVF200</b><br>3'0" x 6'8" | <b>CCVF060</b>   <b>CCVF8060</b><br>3'0" x 6'8"   3'0" x 8'0" | <b>CCVF831</b><br>3'0" x 8'0" | <b>CCVF050</b><br>3'0" x 6'8" |
|-------------------------------|--------------------------------|---|-------------------------------|---|-------------------------------|-------------------------------|

Fiber-Classic.

Mahogany Collection™



|  |   |   |   |   |   |  |   |
|--|---|---|---|---|---|--|---|
| <b>FMF31</b><br>2'8" x 6'8"<br>2'10" x 6'8"<br>3'0" x 6'8" | <b>FMF220</b><br>2'8" x 6'8"<br>2'10" x 6'8"<br>3'0" x 6'8" | <b>FMF205</b><br>2'8" x 6'8"<br>2'10" x 6'8"<br>3'0" x 6'8" | <b>FMF755</b><br>2'8" x 6'8"<br>2'10" x 6'8"<br>3'0" x 6'8" | <b>FMF600</b><br>2'8" x 6'8"<br>2'10" x 6'8"<br>3'0" x 6'8" | <b>FMF134</b><br>2'8" x 6'8"<br>2'10" x 6'8"<br>3'0" x 6'8" | <b>FMF60</b>   <b>FMF860</b><br>2'8" x 6'8"   2'8" x 8'0"<br>2'10" x 6'8"   3'0" x 8'0"<br>3'0" x 6'8" | <b>FMF100</b>   <b>FMF8100</b><br>2'6" x 6'8"   2'6" x 8'0"<br>2'8" x 6'8" ‡   2'8" x 8'0"<br>3'0" x 6'8" ‡   3'0" x 8'0" |
|--|---|---|---|---|---|--|---|

Oak Collection™



|  |   |   |   |   |   |   |   |
|--|---|---|---|---|---|---|---|
| <b>FCF31</b><br>2'8" x 6'8"<br>3'0" x 6'8" | <b>FCF809</b><br>2'8" x 6'8"<br>2'10" x 6'8"<br>3'0" x 6'8" | <b>FCF862</b><br>2'8" x 8'0"<br>2'10" x 8'0"<br>3'0" x 8'0" | <b>FCF808</b><br>2'8" x 6'8"<br>2'10" x 6'8"<br>3'0" x 6'8" | <b>FCF755</b><br>2'8" x 6'8"<br>3'0" x 6'8" | <b>FCF134</b><br>2'8" x 6'8"<br>3'0" x 6'8" | <b>FCF160*</b>   <b>FCF8160</b><br>2'6" x 6'8"   2'8" x 8'0"<br>2'8" x 6'8" ‡   2'10" x 8'0"<br>2'10" x 6'8" ‡   3'0" x 8'0"<br>3'0" x 6'8" ‡ | <b>FCF100</b>   <b>FCF8100</b><br>2'6" x 6'8"   2'6" x 8'0"<br>2'8" x 6'8" ‡   2'8" x 8'0"<br>3'0" x 6'8" ‡   3'0" x 8'0" |
|--|---|---|---|---|---|---|---|

\*Available with elevated 10" bottom rail.

Note: See page 273 for important product details that may help with your purchase decision.



|   |   |   |   |   |  |   |   |  |  |  |
|---|---|---|---|---|--|---|---|--|--|--|
| <b>SSF93</b><br>6<br>2'8" x 6'8"<br>2'10" x 6'8"<br>3'0" x 6'8" | <b>SSF220*</b><br>6<br>2'8" x 6'8" ‡<br>2'10" x 6'8" ‡<br>3'0" x 6'8" ‡ | <b>SSF8220</b><br>6<br>2'8" x 8'0"<br>2'10" x 8'0"<br>3'0" x 8'0" | <b>SSF200</b><br>6<br>2'6" x 6'8"<br>2'8" x 6'8"<br>2'10" x 6'8"<br>3'0" x 6'8" | <b>SSF8200</b><br>6<br>2'8" x 8'0"<br>2'10" x 8'0"<br>3'0" x 8'0" | <b>SSF205</b><br>6<br>2'8" x 6'8"<br>2'10" x 6'8"<br>3'0" x 6'8" | <b>SSF8205</b><br>6<br>2'8" x 8'0"<br>2'10" x 8'0"<br>3'0" x 8'0" | <b>SSF31</b><br>6<br>2'8" x 6'8"<br>2'10" x 6'8"<br>3'0" x 6'8" | <b>SSF831</b><br>6<br>2'8" x 8'0"<br>2'10" x 8'0"<br>3'0" x 8'0" | <b>SSF960</b><br>6<br>2'8" x 6'8"<br>2'10" x 6'8"<br>3'0" x 6'8" | <b>SSF755</b><br>6<br>2'8" x 6'8"<br>2'10" x 6'8"<br>3'0" x 6'8" |
|---|---|---|---|---|--|---|---|--|--|--|

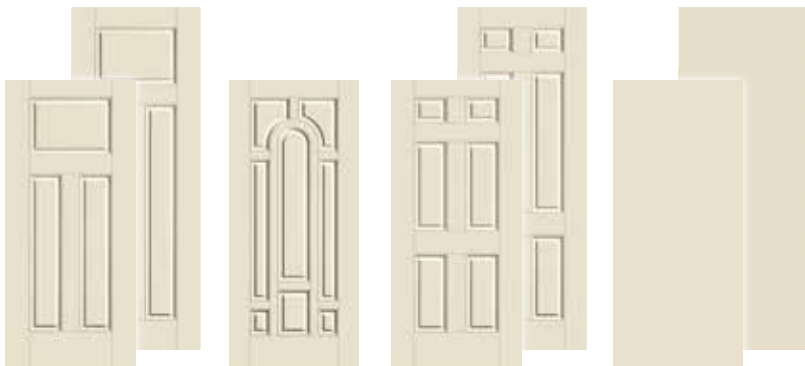

|  |   |   |  |  |  |  |
|--|---|---|--|--|--|--|
| <b>SSF600</b><br>6<br>2'8" x 6'8"<br>2'10" x 6'8"<br>3'0" x 6'8" | <b>SSF8600</b><br>6<br>2'8" x 8'0"<br>2'10" x 8'0"<br>3'0" x 8'0" | <b>SSF11</b><br>6<br>2'8" x 6'8"<br>2'10" x 6'8"<br>3'0" x 6'8" | <b>SSF160*</b><br>6<br>2'6" x 6'8"<br>2'8" x 6'8" ‡<br>2'10" x 6'8" ‡<br>3'0" x 6'8" ‡ | <b>SSF8160</b><br>6<br>2'6" x 8'0"<br>2'8" x 8'0"<br>2'10" x 8'0"<br>3'0" x 8'0" | <b>SSF100</b><br>6<br>2'0" x 6'8"<br>2'6" x 6'8"<br>2'8" x 6'8" ‡<br>2'10" x 6'8" ‡<br>3'0" x 6'8" ‡ | <b>SSF8100</b><br>6<br>2'6" x 8'0"<br>2'8" x 8'0"<br>2'10" x 8'0"<br>3'0" x 8'0" |
|--|---|---|--|--|--|--|

## Profiles™



|   |   |  |
|---|---|--|
| <b>969HD</b><br>6<br>2'8" x 6'8"<br>2'10" x 6'8"<br>3'0" x 6'8" | <b>978HD</b><br>6<br>2'8" x 6'8"<br>2'10" x 6'8"<br>3'0" x 6'8" | <b>1005HD</b><br>6<br>2'8" x 6'8"<br>2'10" x 6'8"<br>3'0" x 6'8" |
|---|---|--|

## Traditions



|   |   |  |  |
|---|---|--|--|
| <b>205HD</b><br>6<br>2'8" x 6'8"<br>2'10" x 6'8"<br>3'0" x 6'8" | <b>203HD</b><br>6<br>2'8" x 6'8"<br>2'10" x 6'8"<br>3'0" x 6'8" | <b>210HD</b><br>6<br>2'6" x 6'8" ‡<br>2'8" x 6'8" ‡<br>2'10" x 6'8" ‡<br>3'0" x 6'8" ‡ | <b>100</b><br>6<br>2'0" x 6'8"<br>2'4" x 6'8"<br>2'6" x 6'8" ‡<br>2'8" x 6'8" ‡<br>2'10" x 6'8" ‡<br>3'0" x 6'8" ‡ |
|---|---|--|--|

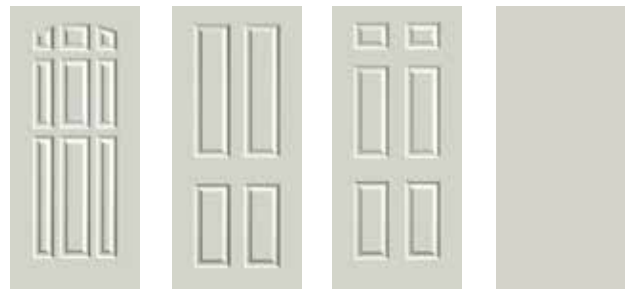

|   |   |  |  |
|---|---|--|--|
| <b>TS290</b><br>6<br>2'8" x 6'8"<br>2'10" x 6'8"<br>3'0" x 6'8" | <b>TS214</b><br>6<br>2'8" x 6'8"<br>2'10" x 6'8"<br>3'0" x 6'8" | <b>TS210</b><br>6<br>2'6" x 6'8"<br>2'8" x 6'8"<br>2'10" x 6'8"<br>3'0" x 6'8" | <b>TS100</b><br>6<br>2'0" x 6'8"<br>2'4" x 6'8" ‡<br>2'6" x 6'8"<br>2'8" x 6'8"<br>2'10" x 6'8" ‡<br>3'0" x 6'8" |
|---|---|--|--|

### Key

- No Stile Lines
- 6 WBDR Options
- 6 WBDR / HVHZ Options
- ⚡ 6'6" Height Available
- ‡ 7'0" Height Available

# PULSE

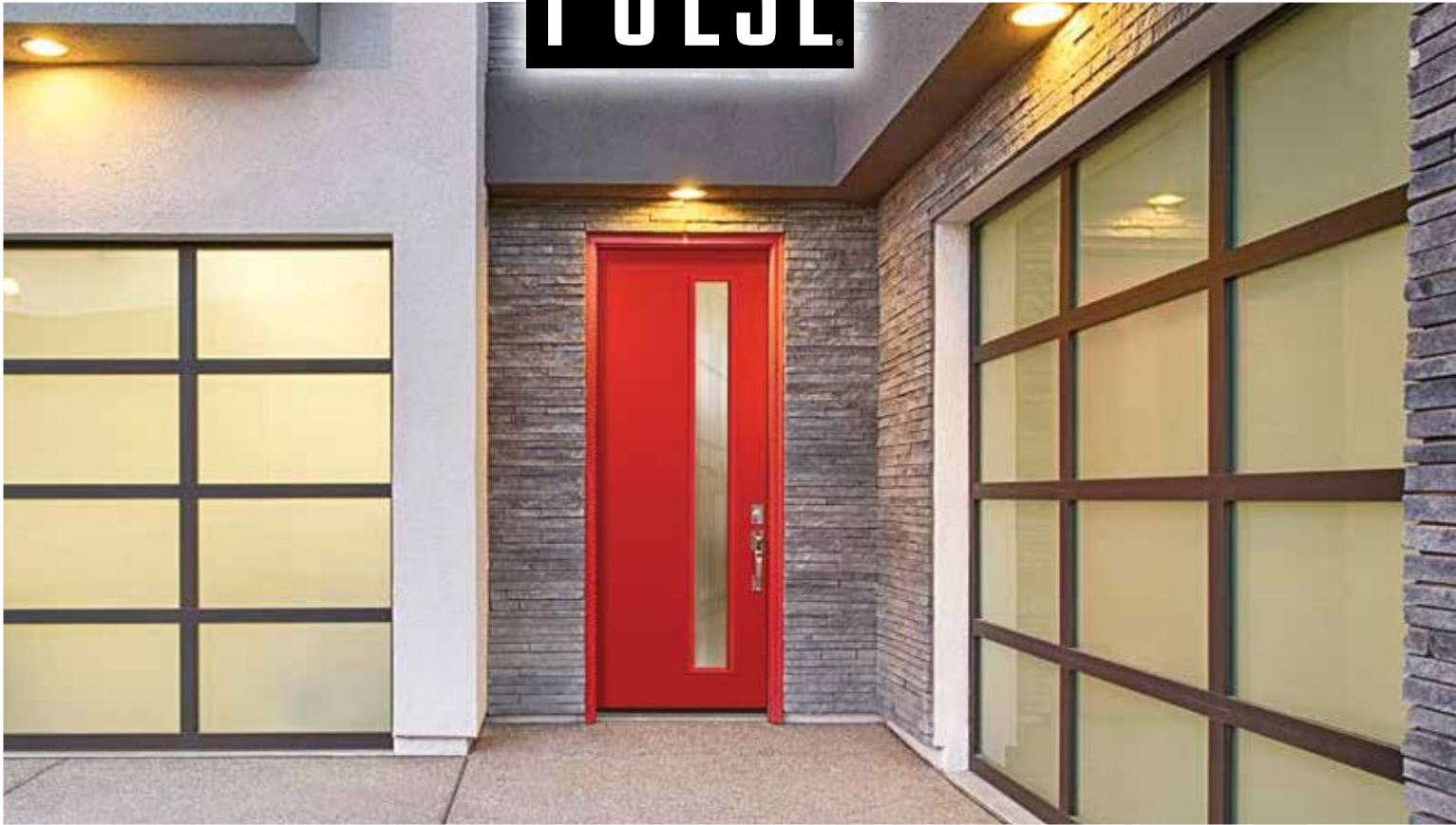

232

•

Modern design. Upbeat living.



Clean lines. Crisp angles. Sleek designs. Vintage style. Pulse is a contemporary series of door styles and glass designs that can be combined to make a bold statement. With three distinct aesthetic approaches – Ari, Línea and Echo – the entrance becomes modern art.

\*Please verify that there is a Therma-Tru product approval for the configuration before buying.  
Note: Finish colors may vary from an actual application due to fluctuations in finishing or printing. Glass designs may differ from depiction due to size and hand craftsmanship of glass. See your Therma-Tru seller or visit [www.thermatru.com](http://www.thermatru.com) for more, including details on limited warranties and exclusions, ENERGY STAR qualified products and product approvals.  
Top: Pulse Línea, Satin Etch Glass with Flat Lite Frame, Door – S81RXE



## It's your decision, by design.

Pulse is geometry with energy. Designed to be fun and easy to mix and match with sleek, flush door and sidelite styles, you can create a modern entrance without missing a beat. Explore all the possible combinations at [www.thermatru.com/pulse](http://www.thermatru.com/pulse). Mix and match to get the style numbers needed to order. Turn the page for a glimpse of available styles and sizes.

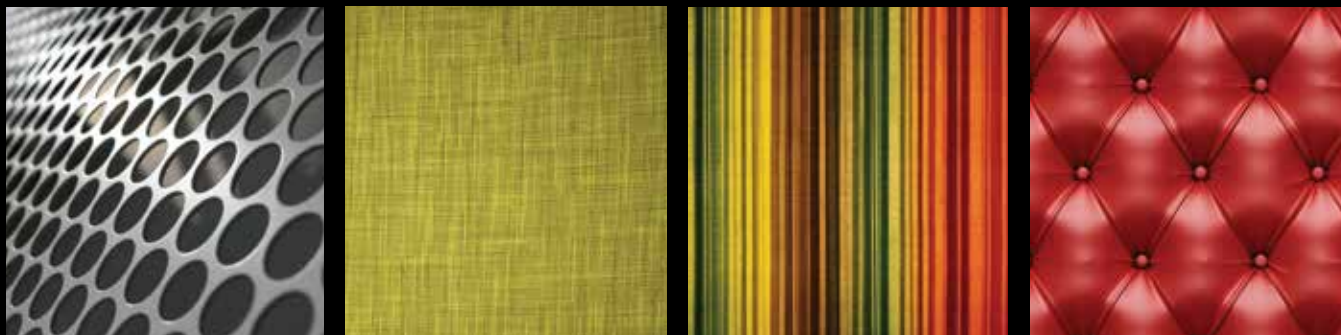
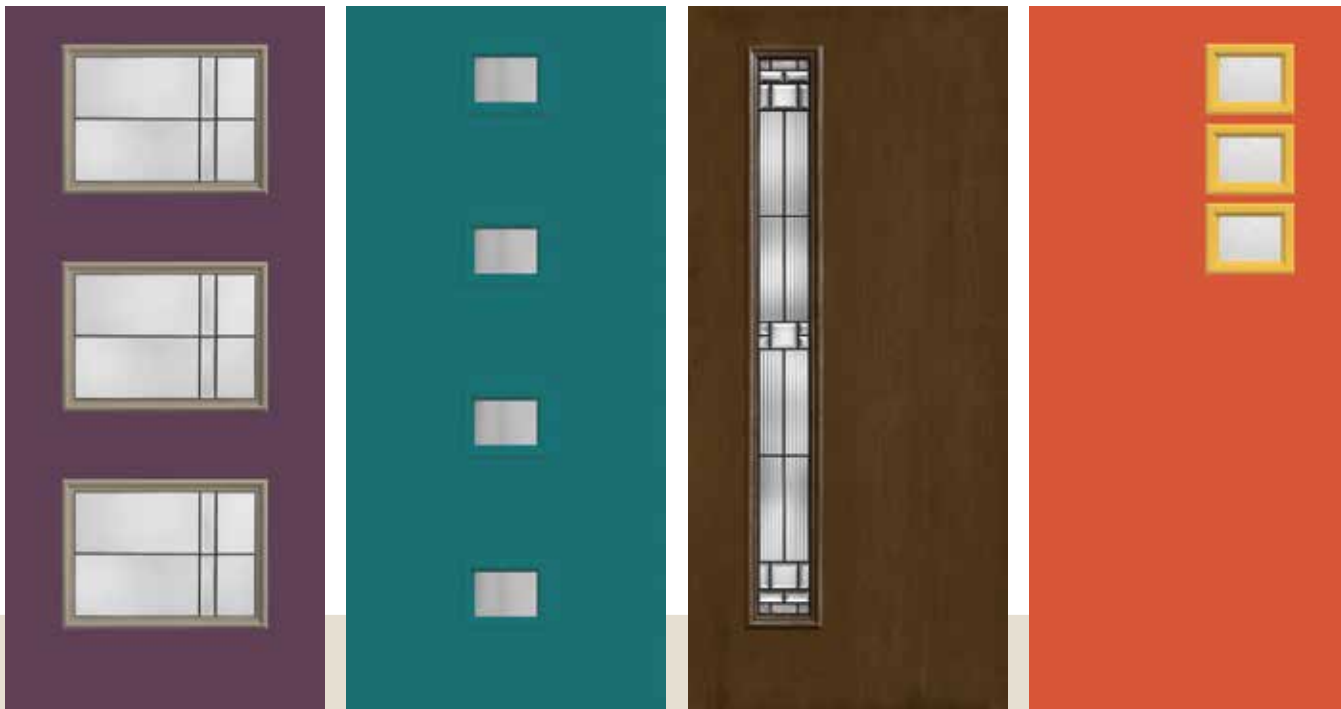

## The creativity is unlimited. Stain or paint the entrance any color.

These doors and sidelites come ready to stain or paint. So there's no limit to the creativity you can use when it comes to finishing touches.



Fiberglass



Steel



WBDR / HVHZ Options: Look for this icon to find door styles that can be configured for WBDR or HVHZ.\*



### 1 Start with a STYLE.

Combine doors and sidelites to create an entrance that fits your vision.

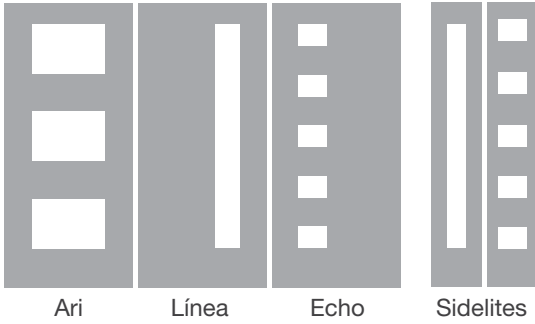

### 2 Choose a MATERIAL.

Each style is available in any of these material choices.



### 3 Select a GLASS.

Find an available glass design to complete the statement you want to make.

#### Privacy & Textured Glass

Available for all Pulse door styles.

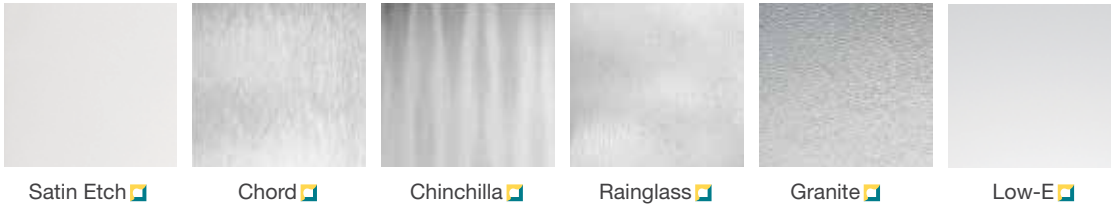

#### Decorative Glass

Available for Línea.

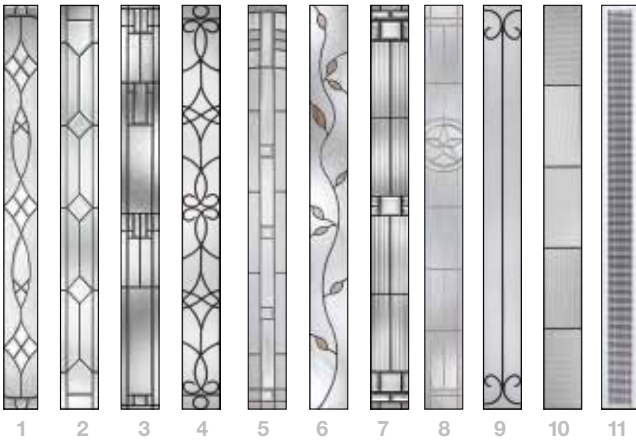

Available for Ari.

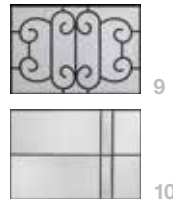

Available for Echo.



- 1 Blackstone®
- 2 Crystalline™
- 3 Sedona
- 4 Salinas®
- 5 Maple Park®
- 6 Avonlea®
- 7 Saratoga™
- 8 Texas Star
- 9 Riserva™
- 10 Axis™
- 11 Internal Blinds

### 4 Then select a FRAME.

Choose the flat profile for modern appeal or scrolled profile for vintage style.



#### Frame Options

- Flat Lite Frame
- Scrolled Lite Frame

Flat Profile Lite Frame\*

Scrolled Profile Lite Frame

\*Not recommended for use behind storm doors or to be painted dark colors, if exposed to direct sunlight.  
Right Page: Pulse Línea, Sedona Glass with Scrolled Lite Frame, Doors – S1SN

### Pulse® Size Options

|           | Wood-Grained Fiberglass |               | Smooth Fiberglass |               | Steel         |               |
|-----------|-------------------------|---------------|-------------------|---------------|---------------|---------------|
|           | 6'8"                    | 8'0"          | 6'8"              | 8'0"          | 6'8"          | 8'0"          |
| Doors     | 2'6" x 6'8" ◦           | 2'6" x 8'0" ◦ | 2'6" x 6'8" ◦     | 2'6" x 8'0" ◦ | 2'6" x 6'8" ◦ | 2'6" x 8'0" ◦ |
|           | 2'8" x 6'8"             | 2'8" x 8'0"   | 2'8" x 6'8"       | 2'8" x 8'0"   | 2'8" x 6'8"   | 2'8" x 8'0"   |
|           | 2'10" x 6'8"            | 2'10" x 8'0"  | 2'10" x 6'8"      | 2'10" x 8'0"  | 2'10" x 6'8"  | 2'10" x 8'0"  |
|           | 3'0" x 6'8"             | 3'0" x 8'0"   | 3'0" x 6'8"       | 3'0" x 8'0"   | 3'0" x 6'8"   | 3'0" x 8'0"   |
|           |                         |               | 3'6" x 6'8"       | 3'6" x 8'0"   | 3'6" x 6'8"   |               |
| Sidelites | 10" x 6'8" •            | 12" x 8'0"    | 10" x 6'8" •      | 12" x 8'0"    | 10" x 6'8" •  | 12" x 8'0"    |
|           | 12" x 6'8"              | 14" x 8'0"    | 12" x 6'8"        | 14" x 8'0"    | 12" x 6'8"    | 14" x 8'0"    |
|           | 14" x 6'8"              |               | 14" x 6'8"        |               | 14" x 6'8"    |               |

- Available in full-lite sidelites only.
- Available in Línea and Echo only.







**Note: Door and sidelite styles shown in smooth fiberglass with scrolled lite frame. To see styles in other material choices, go to [www.thermatru.com/pulse](http://www.thermatru.com/pulse).**

\*Not recommended for use behind storm doors or to be painted dark colors, if exposed to direct sunlight.  
Note: See page 273 for important product details that may help with your purchase decision.

Top: Pulse Ari, Axis Glass with Scrolled Lite Frame, Door – S83AX

Bottom: Pulse Línea, Axis Glass with Flat Lite Frame, Door – FCM1LAX



# Ari

Note: Product images show exterior side of door.



# Línea

Note: Product images show exterior side of door.

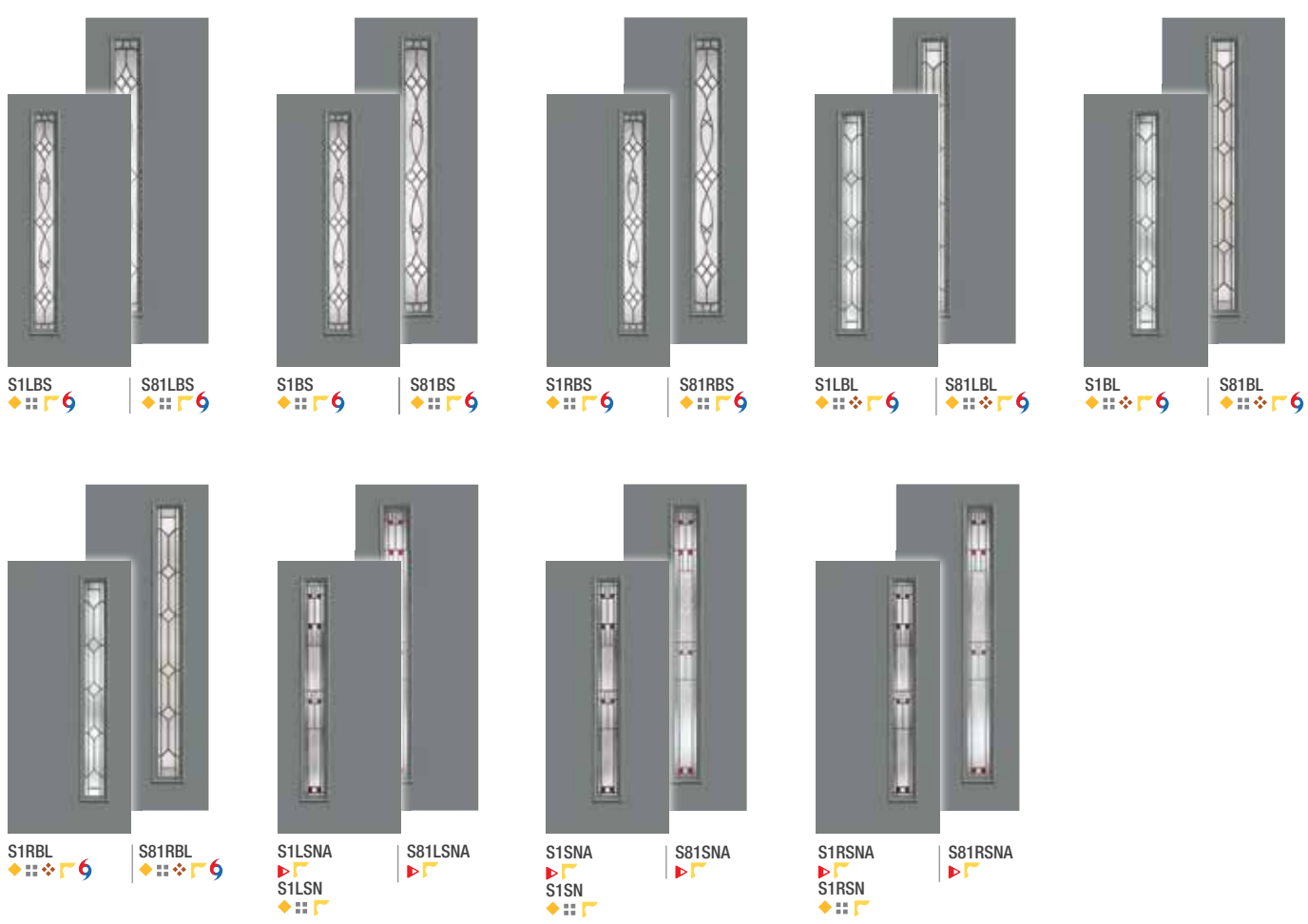

**Línea** Continues on next page.

**Privacy & Textured Glass Options**  
 Add the code to the blank in the style number for the desired door and glass combination. For details on glass options, see page 234.

XE = Satin Etch Glass      XJ = Chinchilla Glass      XN = Granite Glass  
 XC = Chord Glass          XR = Rainglass

**Key**

- ★ Low-E Glass (LE)
- ▶ Art Glass / Black Nickel Caming (1D)
- ◆ Black Nickel Caming (1D)
- Brushed Nickel Caming (1C)
- ◆ Brass Caming (1A)
- ✕ Wrought Iron (1W)
- └ Flat Lite Frame\*
- ◀ Scrolled Lite Frame
- Ⓢ WBDR / HVHZ Options

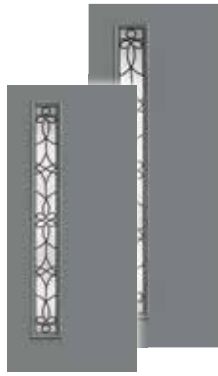

S1LSA XFG  
S81LSA XFG

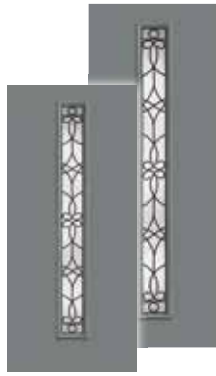

S1SA XFG  
S81SA XFG

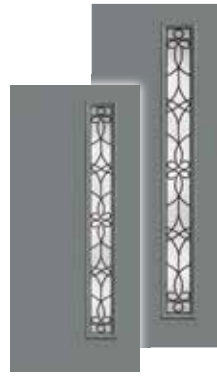

S1RSA XFG  
S81RSA XFG

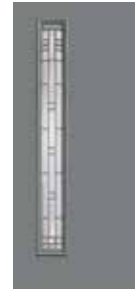

S1LFW DFG  
S1FW DFG

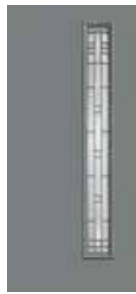

S1RFB DFG



S1LAV DFG



S1AV DFG



S1RAV DFG

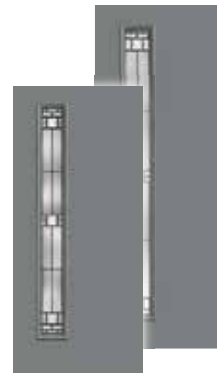

S1LSG DFG  
S81LSG DFG

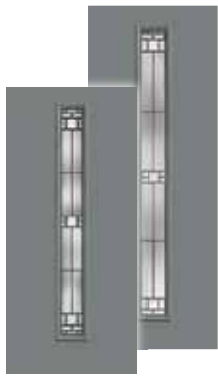

S1SG DFG  
S81SG DFG

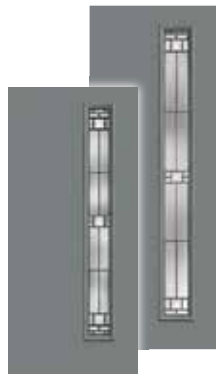

S1RSG DFG  
S81RSG DFG



S1LTX DFG



S1TX DFG



S1RTX DFG

|   |                   |       |
|---|-------------------|-------|
|   |                   |       |
| Wood-Grained Fiberglass:<br>Mahogany or Oak (Shown in Natural Oak stain.) | Smooth Fiberglass | Steel |

**It's your decision, by design.**  
 Select a look for the door and sidelites. Choose a material. Find an available glass design and frame to complete the statement. Stain or paint it any color. Explore all the possible combinations at [www.thermatru.com/pulse](http://www.thermatru.com/pulse).

**Note: Door and sidelite styles shown in smooth fiberglass with scrolled lite frame. To see styles in other material choices, go to [www.thermatru.com/pulse](http://www.thermatru.com/pulse).**

\*Not recommended for use behind storm doors or to be painted dark colors, if exposed to direct sunlight.  
 Note: See page 273 for important product details that may help with your purchase decision.

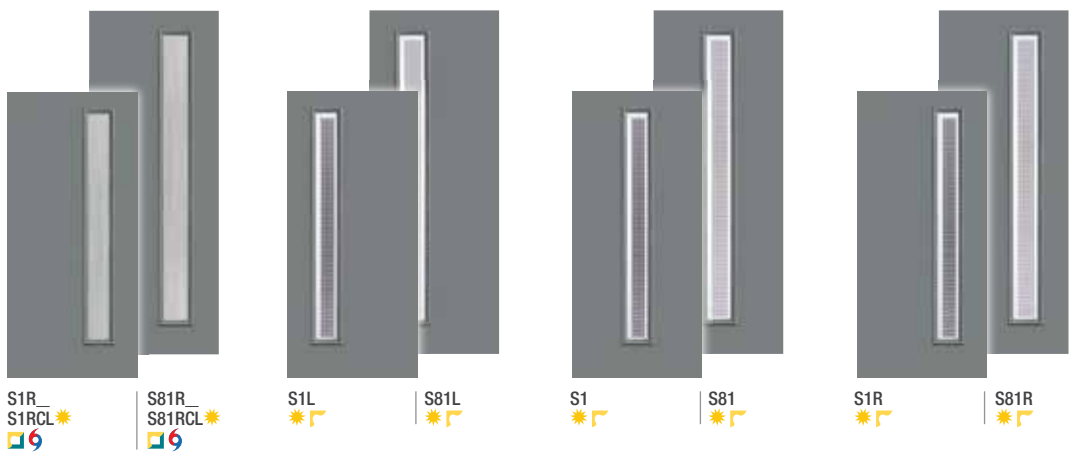
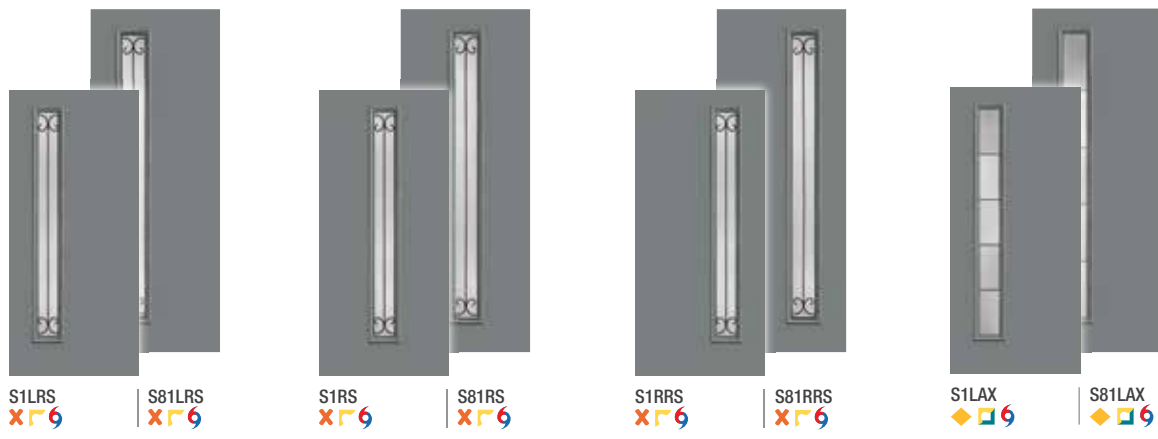

### Privacy & Textured Glass Options

Add the code to the blank in the style number for the desired door and glass combination. For details on glass options, see page 234.

XE = Satin Etch Glass    XJ = Chinchilla Glass    XN = Granite Glass  
XC = Chord Glass        XR = Rainglass

### Key

- Low-E Glass (LE)
- Black Nickel Caming (1D)
- Brushed Nickel Caming (1C)
- Wrought Iron (1W)
- Flat Lite Frame\*
- Scrolled Lite Frame
- WBDR / HVHZ Options

# Echo

Note: Product images show exterior side of door.



S4LAX | S84LAX



S4AX | S84AX



S4RAX | S84RAX

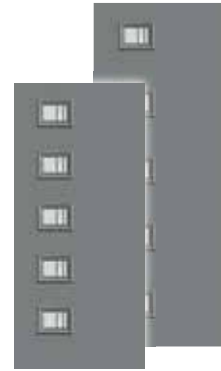

S5LAX | S85LAX



S5AX | S85AX

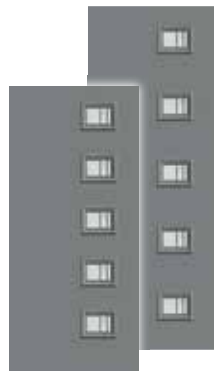

S5RAX | S85RAX



S86LAX



S86AX



S86RAX



S9LAX



S9AX



S9RAX



S8LAX



S8AX



S8RAX



Wood-Grained Fiberglass:  
Mahogany or Oak (Shown in Natural Oak stain.)



Smooth  
Fiberglass



Steel

### It's your decision, by design.

Select a look for the door and sidelites. Choose a material. Find an available glass design and frame to complete the statement. Stain or paint it any color. Explore all the possible combinations at [www.thermatru.com/pulse](http://www.thermatru.com/pulse).

**Note: Door and sidelite styles shown in smooth fiberglass with scrolled lite frame. To see styles in other material choices, go to [www.thermatru.com/pulse](http://www.thermatru.com/pulse).**

\*Not recommended for use behind storm doors or to be painted dark colors, if exposed to direct sunlight.

Note: See page 273 for important product details that may help with your purchase decision.

Right Page: Pulse Echo, Low-E Glass with Flat Lite Frame, Door – S85CL





**Echo** Continues on next page.

**Privacy & Textured Glass Options**

Add the code to the blank in the style number for the desired door and glass combination. For details on glass options, see page 234.

- XE = Satin Etch Glass
- XJ = Chinchilla Glass
- XN = Granite Glass
- XC = Chord Glass
- XR = Rainglass

**Key**

- Low-E Glass (LE)
- Black Nickel Caming (1D)
- Flat Lite Frame\*
- Scrolled Lite Frame
- WBDR / HVHZ Options

# Echo *Continued*

Note: Product images show exterior side of door.

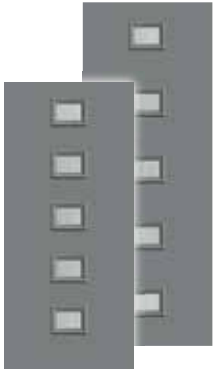

S5\_ S5CL ✨  
S85\_ S85CL ✨

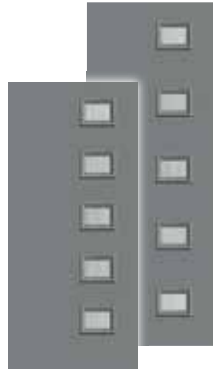

S5R\_ S5RCL ✨  
S85R\_ S85RCL ✨



S86L\_ S86LCL ✨



S86\_ S86CL ✨



S86R\_ S86RCL ✨



S9L\_ S9LCL ✨



S9\_ S9CL ✨



S9R\_ S9RCL ✨



S8L\_ S8LCL ✨



S8\_ S8CL ✨



S8R\_ S8RCL ✨



S811L\_ S811LCL ✨



S811\_ S811CL ✨



S811R\_ S811RCL ✨



S810L\_ S810LCL ✨



S810\_ S810CL ✨



S810R\_ S810RCL ✨

|  |  |  |
|--|--|--|
|  |  |  |
|--|--|--|

**It's your decision, by design.**  
 Select a look for the door and sidelites. Choose a material. Find an available glass design and frame to complete the statement. Stain or paint it any color. Explore all the possible combinations at [www.thermatru.com/pulse](http://www.thermatru.com/pulse).

**Note: Door and sidelite styles shown in smooth fiberglass with scrolled lite frame. To see styles in other material choices, go to [www.thermatru.com/pulse](http://www.thermatru.com/pulse).**

\*Not recommended for use behind storm doors or to be painted dark colors, if exposed to direct sunlight.  
 Note: See page 273 for important product details that may help with your purchase decision.

# Sidelites

Note: Product images show exterior side of door.

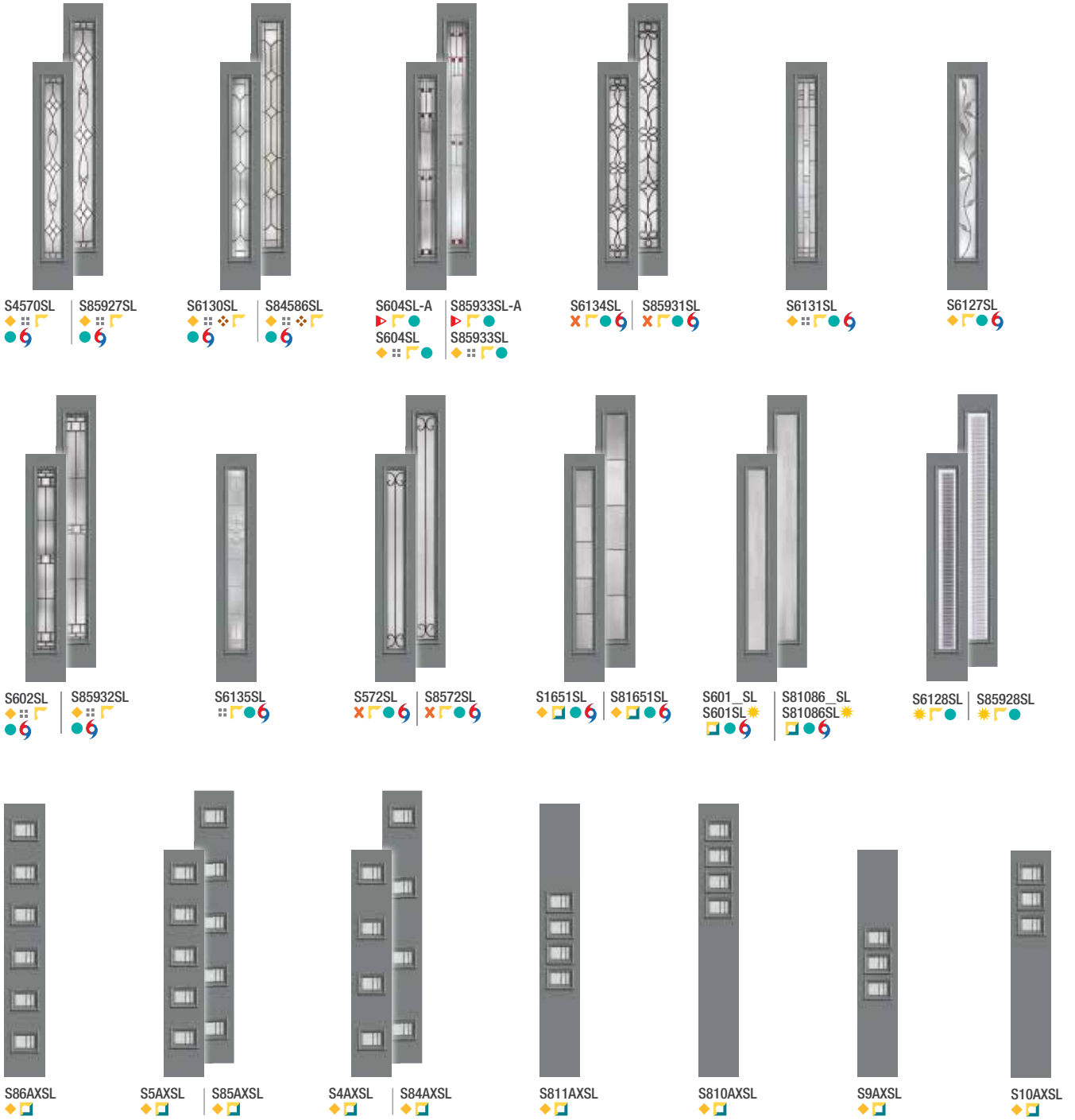

**Sidelites** *Continue on next page.*

## Privacy & Textured Glass Options

Add the code to the blank in the style number for the desired door and glass combination. For details on glass options, see page 234.

XE = Satin Etch Glass  
XC = Chord Glass

XJ = Chinchilla Glass  
XR = Rainglass

XN = Granite Glass

## Key

- Low-E Glass (LE)
- Art Glass / Black Nickel Caming (1A)
- Black Nickel Caming (1D)
- Brushed Nickel Caming (1C)
- Brass Caming (1A)
- Wrought Iron (1W)
- Flat Lite Frame\*
- Scrolled Lite Frame
- Vented Sidelite (No Impact)  
(6'8" & 8'0" in 14")  
(6'8" full-lite only in 12")
- WBDR / HVHZ Options

**Sidelites** *Continued*

Note: Product images show exterior side of door.

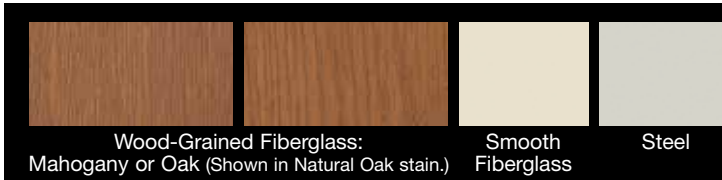

**It's your decision, by design.**

Select a look for the door and sidelites. Choose a material. Find an available glass design and frame to complete the statement. Stain or paint it any color. Explore all the possible combinations at [www.thermatru.com/pulse](http://www.thermatru.com/pulse).

**Key**

- Low-E Glass (LE)
- Flat Lite Frame\*
- Scrolled Lite Frame
- Vented Sidelite (No Impact)  
(6'8" & 8'0" in 14")  
(6'8" full-lite only in 12")

**Privacy & Textured Glass Options**

Add the code to the blank in the style number for the desired door and glass combination. For details on glass options, see page 234.

- XE = Satin Etch Glass
- XC = Chord Glass
- XJ = Chinchilla Glass
- XR = Rainglass
- XN = Granite Glass

**Note: Door and sidelite styles shown in smooth fiberglass with scrolled lite frame. To see styles in other material choices, go to [www.thermatru.com/pulse](http://www.thermatru.com/pulse).**

\*Not recommended for use behind storm doors or to be painted dark colors, if exposed to direct sunlight.  
Note: See page 273 for important product details that may help with your purchase decision.

Top Left: Pulse Línea, Satin Etch Glass with Flat Lite Frame, Door – S1RXE, Sidelite – S601XESL  
Top Right: Pulse Ari, Satin Etch Glass with Flat Lite Frame, Door – S83XE  
Right Page: Pulse Echo, Low-E Glass with Flat Lite Frame, Door – S811CL, Sidelites – S81086SL





# Hinged Patio Doors



246



• Simply beautiful, any way you see it.



Extend the beauty and quality of a Therma-Tru® entrance to the back of the home with hinged patio doors. Find style and convenience that's unsurpassed from any view with smart options to control the level of privacy and light, complement window patterns, and let fresh air into the home.



Note: Finish colors may vary from an actual application due to fluctuations in finishing or printing. See your Therma-Tru seller or visit [www.thermatru.com](http://www.thermatru.com) for details on limited warranties and exclusions, and ENERGY STAR qualified products.

Top: Smooth-Star, Clear Glass, Doors - S140, Transoms - 19200T  
 Bottom: Smooth-Star, Clear Glass with GBGs, Doors - S81828

## Door Selections

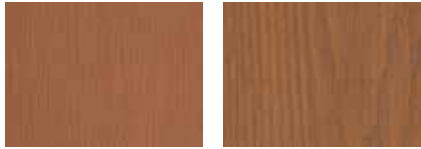

Classic-Craft<sup>®</sup>  
Mahogany  
Collection™

Classic-Craft<sup>®</sup>  
Oak Collection™



Classic-Craft<sup>®</sup>  
Rustic Collection™

Classic-Craft<sup>®</sup>  
Canvas  
Collection



Fiber-Classic<sup>®</sup>  
Mahogany  
Collection™

Fiber-Classic<sup>®</sup>  
Oak Collection™



Smooth-Star<sup>®</sup>

Profiles™ & Traditions

(Wood-grained images shown in Natural Oak stain.)

## Glass Selections

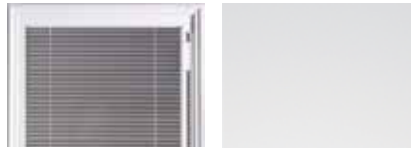

Internal Blinds

Clear

### Divided Lites

For details on divided lite options, see page 120–121.



## Low-E Glass



Energy-efficient Low-E glass can help keep a home warm in the winter and cool in the summer. Available for internal blinds, divided lites and clear glass.

### Flush-Glazed Glass

Glass built directly into the door during the manufacturing process offers a seamless appearance, wider daylight opening and high-performance weather seal.

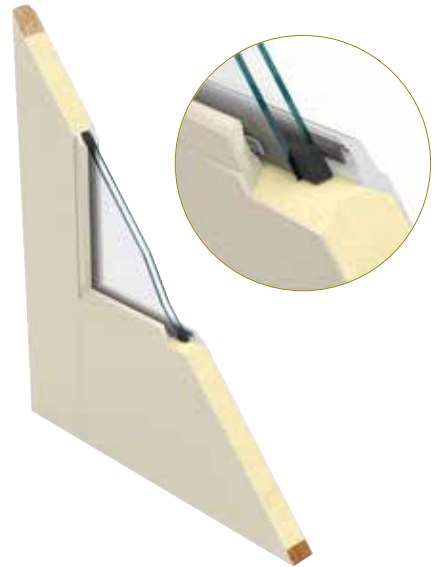

■ = Available • = Not Applicable

| Door Selections  | Classic-Craft <sup>®</sup>           | Fiber-Classic <sup>®</sup>                   | Smooth-Star <sup>®</sup>                     | Profiles™                            | Traditions                           |
|--|--------------------------------------|--|--|--------------------------------------|--------------------------------------|
| Material   | Fiberglass                           | Fiberglass                                   | Fiberglass                                   | Steel                                | Steel                                |
| Warranty   | Lifetime                             | Lifetime                                     | Lifetime                                     | 10 Years                             | Door: 5 Years / Glass: 10 Years      |
| Finish Options   | Stain or Paint                       | Stain or Paint                               | Paint  | Paint                                | Paint                                |
| <b>Glass Selections</b>  |                                      |  |  |                                      |                                      |
| Internal Blinds  | •                                    | ■  | ■  | ■                                    | ■                                    |
| Flush-Glazed with Divided Lites  | •                                    | ■  | ■  | •                                    | •                                    |
| Flush-Glazed Clear   | •                                    | ■  | ■  | •                                    | •                                    |
| Low-E with Divided Lites   | Standard                             | Option                                       | Option                                       | Option                               | Option                               |
| Low-E  | Standard                             | Option                                       | Option                                       | Option                               | Option                               |
| Clear with Divided Lites   | •                                    | ■  | ■  | ■                                    | ■                                    |
| Clear  | •                                    | ■  | ■  | ■                                    | ■                                    |
| Also Available   | 13 Decorative / 4 Privacy & Textured | 14 Decorative / 5 Privacy & Textured         | 14 Decorative / 5 Privacy & Textured         | 14 Decorative / 5 Privacy & Textured | 14 Decorative / 5 Privacy & Textured |
| <b>Available Sizes</b>   |                                      |  |  |                                      |                                      |
| Heights  | 6'8", 8'0"                           | 6'6", 6'8", 7'0", 8'0"                       | 6'6", 6'8", 7'0", 8'0"                       | 6'6", 6'8", 7'0"                     | 6'6", 6'8", 8'0"                     |
| Single Widths  | 3'0"                                 | 2'0"–3'0"                                    | 2'0"–3'6"                                    | 2'0"–3'6"                            | 2'0"–3'0"                            |
| Double Widths  | 6'0"                                 | 4'0"–6'0"                                    | 4'0"–6'0"                                    | 4'0"–6'0"                            | 4'0"–6'0"                            |
| Triple Widths  | 9'0"                                 | 6'0"–9'0"                                    | 6'0"–9'0"                                    | 6'0"–9'0"                            | 6'0"–9'0"                            |
| Retrofit Openings  | •                                    | 5'0", 6'0"                                   | 5'0", 6'0"                                   | 5'0", 6'0"                           | 5'0", 6'0"                           |
| <b>Additional Options</b>  |                                      |  |  |                                      |                                      |
| Vented Sidelites (Single / Double Widths)                              | •                                    | 6'6", 6'8", 8'0" Heights in 2'4"–6'0" Widths | 6'6", 6'8", 8'0" Heights in 2'4"–6'0" Widths | •                                    | •                                    |
| Screens & Screen Accessories Available<br>Colors: Bronze, Stone, White | 2" Frame, 3" Frame                   | 2" Frame, 3" Frame                           | 2" Frame, 3" Frame                           | 2" Frame, 3" Frame                   | 2" Frame, 3" Frame                   |
| Impact-Rated Options   | •                                    | ■  | ■  | ■                                    | ■                                    |
| Tru-Defense Eligible   | ■                                    | ■  | ■  | •                                    | •                                    |



# Hinged Patio Door Systems



- 1 Multi-Point Locking System (Recommended)
- 2 Bottom Sweep
- 3 Sill
- 4 Hinges
- 5 Corner Seal Pads (Inswing Only)
- 6 Sill Pan (Recommended)
- 7 Astragal
- 8 Frame Components
- 9 Multi-Point Locking System (Included)
- 10 Removable Screens

A Therma-Tru® patio door with genuine Therma-Tru components is a complete door system with doors, glass and components engineered to work together for durability and reliability through the years.

## Patio Transoms

Transoms can be stained or painted to match a Fiber-Classic® or Smooth-Star® door system. Available for 5'0", 5'4", 5'8" and 6'0" patio openings.

Note: Patio transoms are designed for a unit with a mullion.

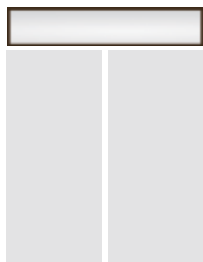

19250T

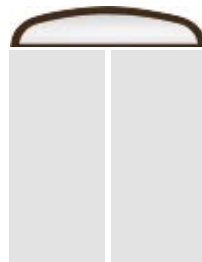

19050T

## Vented Sidelites

**Enjoy the view – and a fresh breeze, too.**

- Constructed to provide ventilation without sliding screens blocking the view, vented sidelites work as small swinging doors with convenient removable screens — available in bronze and white.
- Engineered for durability and safety with wide patio mullions for strength, and multi-point locking gears and recessed strike plates for security.

### Available Configurations



Single Door with Vented Sidelites (Inswing Only)



Double Doors with Vented Sidelites (Inswing Only)





## Internal Blinds



### Available Door Styles

Fiber-Classic® Mahogany (Page 174) / Fiber-Classic® Oak (Page 174) / Smooth-Star® (Page 175) / Profiles® (Page 217) / Traditions (Page 222)  
 See page numbers above for door styles and sizes.



### Available Configurations

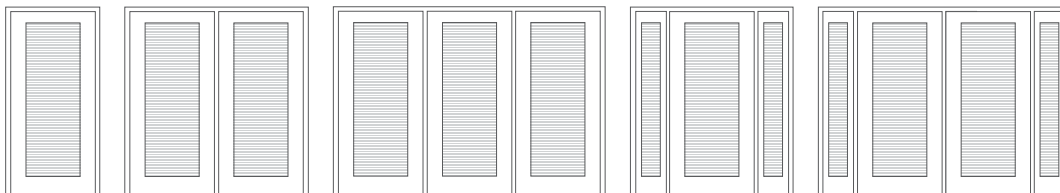

# Flush-Glazed Clear Glass with Divided Lites

## Colonial Style



### Available Door Styles

Fiber-Classic® Oak (Page 177) / Smooth-Star® (Page 179)  
 See page numbers above for door styles and sizes.



### Available Configurations

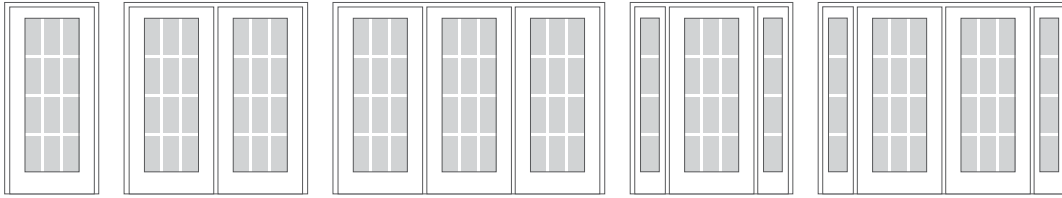

## Craftsman Style



### Available Door Styles

Fiber-Classic® Oak (Page 177) / Smooth-Star® (Page 180)  
 See page numbers above for door styles and sizes.



### Available Configurations

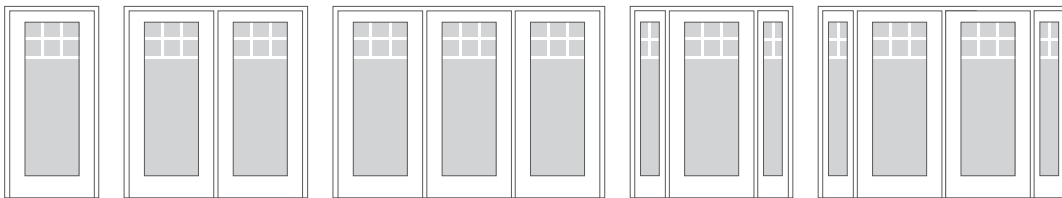

Note: See page 273 for important product details that may help with your purchase decision.

# Prairie Style



### Available Door Styles

Fiber-Classic® Oak (Page 178) / Smooth-Star® (Page 181)  
 See page numbers above for door styles and sizes.

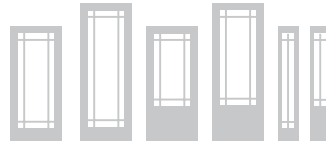

### Available Configurations

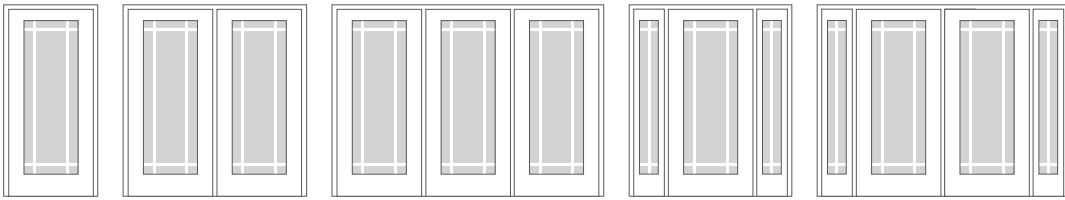

# Flush-Glazed Clear Glass



### Available Door Styles

Fiber-Classic® Oak (Page 182) / Smooth-Star® (Page 182)  
 See page numbers above for door styles and sizes.



### Available Configurations

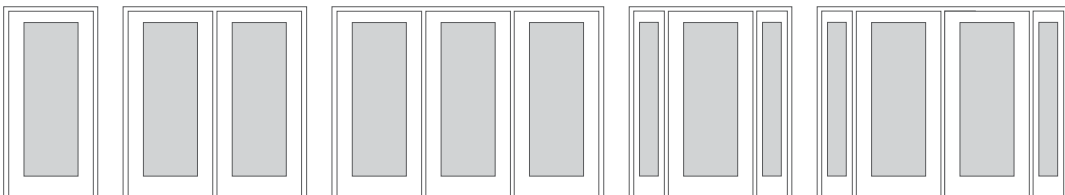

# Low-E / Clear Glass with Divided Lites

## Colonial Style



### Available Door Styles

Classic-Craft® Oak (Page 90) / Classic-Craft® Canvas (Page 107) / Fiber-Classic® Mahogany (Page 183) / Fiber-Classic® Oak (Page 186) / Smooth-Star® (Page 191) / Profiles™ (Page 217) / Traditions (Page 223)  
 See page numbers above for door styles and sizes.



### Available Configurations

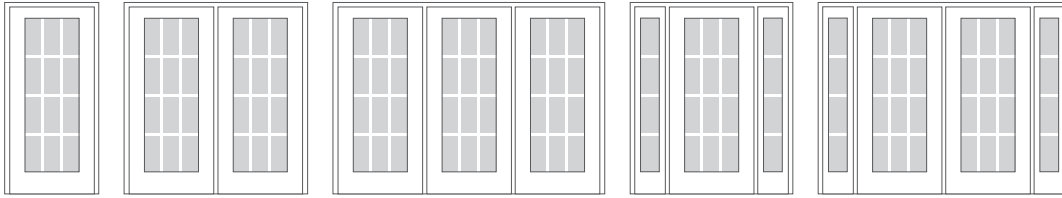

## Craftsman Style



### Available Door Styles

Fiber-Classic® Mahogany (Page 185) / Fiber-Classic® Oak (Page 189) / Smooth-Star® (Page 194) / Profiles™ (Page 218) / Traditions (Page 224)  
 See page numbers above for door styles and sizes.



### Available Configurations

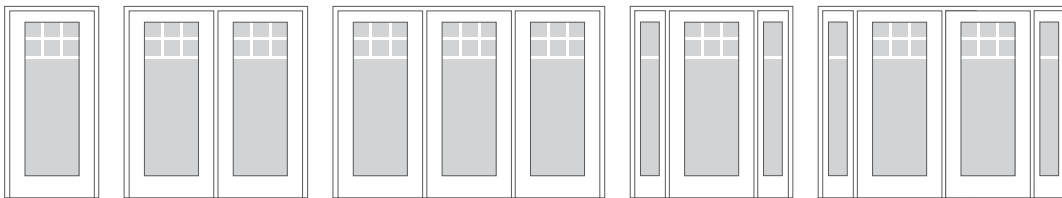

Note: See page 273 for important product details that may help with your purchase decision.



# Prairie Style



### Available Door Styles

Fiber-Classic® Mahogany (Page 185) / Fiber-Classic® Oak (Page 190) / Smooth-Star® (Page 195) / Profiles™ (Page 219) / Traditions (Page 224)  
 See page numbers above for door styles and sizes.

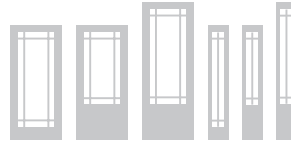

### Available Configurations

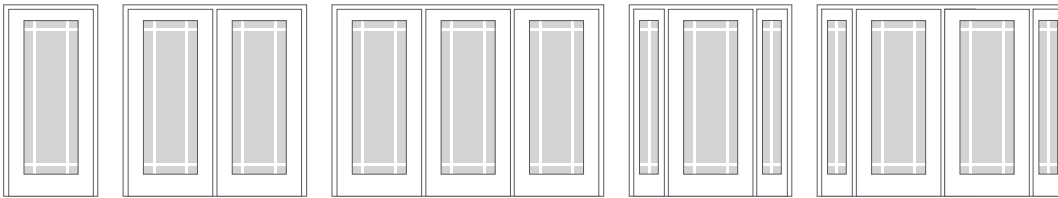

# Low-E / Clear Glass



### Available Door Styles

Classic-Craft® Mahogany (Page 62) / Classic-Craft® Rustic (Page 78) / Classic-Craft® Oak (Page 90) / Classic-Craft® Canvas (Page 107) / Fiber-Classic® Mahogany (Page 196) / Fiber-Classic® Oak (Page 197) / Smooth-Star® (Page 198) / Profiles™ (Page 219) / Traditions (Page 225)  
 See page numbers above for door styles and sizes.



### Available Configurations

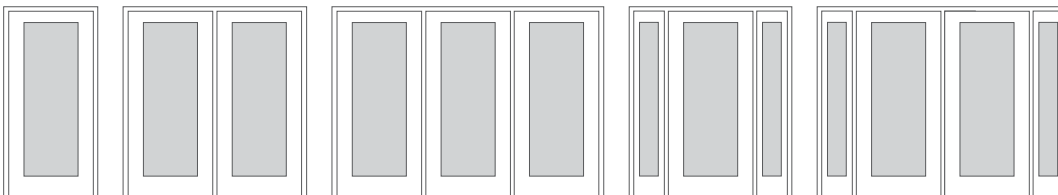





# Door System Components



255

- Engineered to work together.



More than a beautiful door. A Therma-Tru® door system with genuine Therma-Tru components is engineered with craftsman precision for durability and reliability through the years. With weather resistance and energy efficiency so the door performs as exceptionally as it looks.

Visit our online replacement parts configurator and helpful videos to maintain the integrity of a complete door system with genuine Therma-Tru components – [www.thermatru.com/parts](http://www.thermatru.com/parts).

# Sills

Allow for a tight seal to help block wind-driven moisture infiltration at the bottom of the door. Available in a variety of materials with features to meet the needs of different climates and exposures. Ask your Therma-Tru seller for a complete list of options.

## Inswing Options



**Composite Adjustable Sill** 

- Thick wood-grained composite cap and nosing.
- U-shaped weather seal.

Continuous length with spread mullion capability to fill 49"–75" rough openings.\*



**Hardwood Adjustable Sill**

- Durable hardwood cap and nosing can be stained to match door and trim.
- U-shaped weather seal.
- Adjustable flush zinc dichromate screws.



**Basic Composite Adjustable Sill**

- Wood-grained composite cap and nosing.
- Adjustable zinc dichromate screws with removable screw caps.



**Basic Fixed Sill**

- Slanted cap and nosing mates with the single-bulb bottom sweep.



**Moderate Climate Sill**  
(For Warmer Climates)

- All-aluminum construction.
- Slanted cap.

## Inswing Sill Extenders

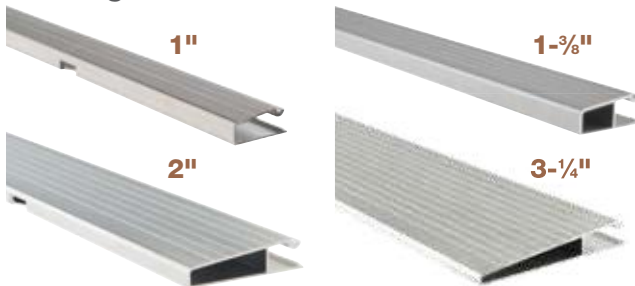

## Outswing Options



**Composite Outswing Sill** 

- Thick wood-grained composite cap and nosing.
- Integrated weatherstrip.



**Aluminum Sill with Thermal Break**

- All-aluminum construction.
- Integrated weatherstrip.
- Also available without thermal break.



**Coastal Sill** (For Coastal Regions)

- All-aluminum construction.
- Extra-high cap profile.
- Integrated weatherstrip.
- Helps meet code requirements in HVHZ coastal regions.

## Outswing Sill Extender



## Public Access Sill



**Public Access Sill with Thermal Break\*\***  
(For ADA Applications)

- All-aluminum construction.
- Ramp slope meets Americans with Disabilities Act (ADA) requirements.
- Also available without thermal break.

### Key

 Tru-Defense Eligible

\*See the Therma-Tru Architectural Details & Components manual for actual unit size specifications.

\*\*Door systems built with public access sills have little resistance to water penetration and have a potential to leak if installed exposed to weather. We recommend these systems be installed away from weather under large soffits or overhangs.

\*\*\*For full details on the Tru-Defense Warranty Rider, visit [www.thermatru.com/trudefense](http://www.thermatru.com/trudefense).

Note: Finish colors may vary from an actual application due to fluctuations in finishing or printing. See page 273 for important product details that may help with your purchase decision.



## Sill Finishes

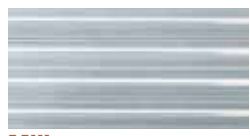

**Mill**

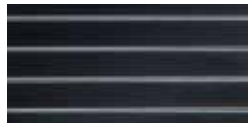

**Bronze**



**Brass**



**Satin Nickel**

## Cap Colors



**Lightwood (Premium)**  
Composite Adjustable /  
Composite Outswing



**Darkwood (Premium)**  
Composite Adjustable /  
Composite Outswing



**Lightwood (Economy)**  
Basic Composite Adjustable



**Darkwood (Economy)**  
Basic Composite Adjustable /  
Basic Fixed



**Hardwood**  
Hardwood Adjustable

■ = Available  
● = Not Applicable

|                                | Inswing Options      |                     |                            |             |                  | Outswing Options   |                             |                                |         |                                    | Public Access (Inswing / Outswing) |  |
|--------------------------------|----------------------|---------------------|----------------------------|-------------|------------------|--------------------|-----------------------------|--------------------------------|---------|------------------------------------|------------------------------------|--|
|                                | Composite Adjustable | Hardwood Adjustable | Basic Composite Adjustable | Basic Fixed | Moderate Climate | Composite Outswing | Aluminum with Thermal Break | Aluminum without Thermal Break | Coastal | Public Access (Inswing / Outswing) | Public Access (ADA)**              |  |
| <b>Sill Finishes</b>           |                      |                     |                            |             |                  |                    |                             |                                |         |                                    |                                    |  |
| Mill                           | ■                    | ■                   | ■                          | ■           | ■                | ■                  | ■                           | ■                              | ■       | ■                                  | ■                                  |  |
| Bronze                         | ■                    | ■                   | ■                          | ■           | ●                | ■                  | ■                           | ■                              | ●       | ■                                  | ■                                  |  |
| Brass                          | ■                    | ●                   | ●                          | ●           | ●                | ■                  | ●                           | ●                              | ●       | ●                                  | ●                                  |  |
| Satin Nickel                   | ■                    | ●                   | ●                          | ●           | ●                | ■                  | ●                           | ●                              | ●       | ●                                  | ●                                  |  |
| <b>Cap Colors</b>              |                      |                     |                            |             |                  |                    |                             |                                |         |                                    |                                    |  |
| Lightwood                      | ■                    | ●                   | ■                          | ●           | ●                | ■                  | ●                           | ●                              | ●       | ●                                  | ●                                  |  |
| Darkwood                       | ■                    | ●                   | ■                          | ■           | ●                | ■                  | ●                           | ●                              | ●       | ●                                  | ●                                  |  |
| Hardwood                       | ●                    | ■                   | ●                          | ●           | ●                | ●                  | ●                           | ●                              | ●       | ●                                  | ●                                  |  |
| <b>Sill Configurations</b>     |                      |                     |                            |             |                  |                    |                             |                                |         |                                    |                                    |  |
| Single                         | ■                    | ■                   | ■                          | ■           | ■                | ■                  | ■                           | ■                              | ■       | ■                                  | ■                                  |  |
| French                         | ■                    | ■                   | ●                          | ■           | ■                | ■                  | ■                           | ■                              | ■       | ■                                  | ■                                  |  |
| Double Patio                   | ■                    | ■                   | ●                          | ●           | ●                | ■                  | ●                           | ●                              | ●       | ●                                  | ●                                  |  |
| Triple Patio                   | ■                    | ■                   | ●                          | ●           | ●                | ■                  | ●                           | ●                              | ●       | ●                                  | ●                                  |  |
| Lineal                         | ■                    | ■                   | ●                          | ●           | ●                | ●                  | ●                           | ●                              | ●       | ●                                  | ●                                  |  |
| <b>Sidelite Configurations</b> |                      |                     |                            |             |                  |                    |                             |                                |         |                                    |                                    |  |
| Boxed Sidelites                | ■                    | ●                   | ●                          | ●           | ●                | ●                  | ●                           | ●                              | ●       | ●                                  | ●                                  |  |
| Single with Sidelites          | ■                    | ■                   | ●                          | ●           | ●                | ■                  | ●                           | ●                              | ●       | ●                                  | ●                                  |  |
| French with Sidelites          | ■                    | ●                   | ●                          | ●           | ●                | ●                  | ●                           | ●                              | ●       | ●                                  | ●                                  |  |
| Single Vented Sidelites        | ■                    | ●                   | ●                          | ●           | ●                | ●                  | ●                           | ●                              | ●       | ●                                  | ●                                  |  |
| French Vented Sidelites        | ■                    | ●                   | ●                          | ●           | ●                | ●                  | ●                           | ●                              | ●       | ●                                  | ●                                  |  |
| <b>Depths</b>                  |                      |                     |                            |             |                  |                    |                             |                                |         |                                    |                                    |  |
| 4-9/16"                        | ■                    | ●                   | ■                          | ■           | ●                | ●                  | ●                           | ■                              | ■       | ■                                  | ■                                  |  |
| 5-3/4"                         | ■                    | ■                   | ■                          | ■           | ■                | ■                  | ■                           | ●                              | ●       | ●                                  | ●                                  |  |
| 6-9/16"                        | ●                    | ●                   | ●                          | ●           | ●                | ●                  | ●                           | ●                              | ●       | ■                                  | ■                                  |  |
| 7-3/4"                         | ■                    | ■                   | ■                          | ■           | ●                | ●                  | ■                           | ●                              | ●       | ●                                  | ●                                  |  |
| <b>Substrates</b>              |                      |                     |                            |             |                  |                    |                             |                                |         |                                    |                                    |  |
| Composite Extruded             | ■                    | ●                   | ●                          | ●           | ●                | ■                  | ●                           | ●                              | ●       | ●                                  | ●                                  |  |
| Composite Injection Molded     | ■                    | ●                   | ■                          | ●           | ●                | ●                  | ●                           | ●                              | ●       | ●                                  | ●                                  |  |
| Treated Pine                   | ●                    | ■                   | ●                          | ■           | ●                | ●                  | ■                           | ■                              | ■       | ●                                  | ●                                  |  |
| Composite Blocked              | ●                    | ●                   | ●                          | ●           | ■                | ●                  | ●                           | ●                              | ●       | ●                                  | ●                                  |  |
| <b>Other Options</b>           |                      |                     |                            |             |                  |                    |                             |                                |         |                                    |                                    |  |
| Integrated Thermal Break       | ■                    | ■                   | ■                          | ■           | ●                | ■                  | ■                           | ●                              | ●       | ■                                  | ■                                  |  |
| Screen Rail Available          | ■                    | ■                   | ●                          | ●           | ●                | ■                  | ●                           | ●                              | ●       | ●                                  | ●                                  |  |
| Sill Extenders Available       | ■                    | ■                   | ■                          | ●           | ●                | ■                  | ●                           | ●                              | ●       | ●                                  | ●                                  |  |
| Sill Covers Available          | ■                    | ■                   | ■                          | ■           | ■                | ■                  | ●                           | ●                              | ●       | ●                                  | ●                                  |  |
| Tru-Defense Eligible***        | ■                    | ●                   | ●                          | ●           | ●                | ■                  | ●                           | ●                              | ●       | ●                                  | ●                                  |  |
| With Anchor Holes              | ●                    | ●                   | ●                          | ●           | ●                | ●                  | ■                           | ■                              | ●       | ■                                  | ■                                  |  |
| Without Anchor Holes           | ■                    | ■                   | ■                          | ■           | ■                | ■                  | ■                           | ●                              | ■       | ●                                  | ●                                  |  |

# Door Bottoms

Designed to mate with our sills and help provide added protection to help seal the margin between the door and sill. Kerf-applied for a secure fit and made of a heavy-duty material that holds its shape to help maintain contact.

## Inswing Options



### Kerf-Applied Dual-Bulb / Dual-Fin Bottom Sweep

**Sills:**  
Composite Adjustable  
Hardwood Adjustable  
Basic Composite Adjustable

**Colors:**  
Bronze  
White



Non-kerf-applied option available for replacement applications. Available in bronze only.



### Kerf-Applied Single-Bulb Bottom Sweep

**Sills:**  
Basic Fixed  
Moderate Climate

**Colors:**  
Bronze



### Inactive Door Bottom

**Sills:**  
Composite Adjustable  
Hardwood Adjustable

**Colors:**  
Bronze

## Outswing Options



### Outswing Bottom Sweep

**Sills:**  
Composite Outswing  
Aluminum  
Coastal

**Color:**  
Bronze



### Inactive Door Bottom

**Sills:**  
Composite Outswing

**Colors:**  
Bronze

## ADA / Replacement



### Bottom Sweep

**Sills:**  
Public Access

**Color:**  
Bronze

# Sill Protection



### Sill Covers (Recommended)

- Fits over the sill to help protect cap and finish from damage during installation.
- Made of a heavy-duty material to withstand wear.
- Available in a variety of options to fit our sills.

See page 256 for availability.

Shown over composite adjustable sill.



### Sill Pan (Recommended)

- Fits between the sill and subfloor for an added layer of protection against moisture.
- Engineered with sloped channels to help collect and drain moisture away.

# Corner Seal Pads (Inswing Only)

Fit securely behind weatherstrip and mate with our inswing sills to help block wind-driven moisture from pushing through the corner and up the frame. (Not required for outswing sills.)

## Classic-Craft. 7-Shape Pads



**Colors:**  
Bronze  
White

**Sills:**  
Composite Adjustable  
Hardwood Adjustable  
Basic Composite Adjustable  
Public Access

## Fiber-Classic. / Smooth-Star. 7-Shape Pads



**Colors:**  
Bronze  
White

**Sills:**  
Composite Adjustable  
Hardwood Adjustable  
Basic Composite Adjustable  
Public Access

## Basic Fixed Pads



**Colors:**  
Bronze

**Sills:**  
Basic Fixed  
Moderate Climate

# Weatherstrip

Engineered in a variety of profiles for a precise seal between the door and frame. Made of a flexible, foam-filled material protected by a durable jacket to resist moisture and wear.

## Medium-Reach Weatherstrip



**Colors:**  
Bronze  
White

## Long-Reach Weatherstrip



**Colors:**  
Bronze  
White

# Rain Protection (Recommended)

Helps repel moisture away from areas exposed to wind-driven moisture infiltration, enhancing weather protection. Highly recommended for applications directly exposed to wind and rain.

## Rain Deflector (Inswing)



**Colors:**  
Bronze  
White

## Rain Guard (Outswing)



**Colors:**  
Bronze  
White

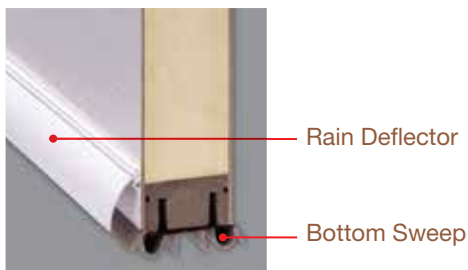

Bottom of door; exterior view.

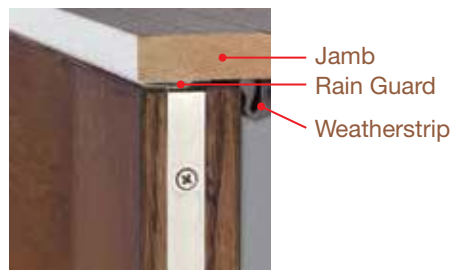

Top of door; exterior view.

## Key

Tru-Defense Eligible

# Hardware

## Multi-Point Locking Systems (MPLS) (Recommended)

Engages the door and frame at three critical points from top to bottom for enhanced stability compared to traditional deadbolt assemblies. Features premium stainless steel construction that resists corrosion.

### NEW Grip-Style MPLS

New grip-style handlesets offer an intuitive approach to the multi-point locking system with on-trend aesthetics. A simple 90-degree twist of the thumbturn (interior) or a key (exterior) is all it takes to engage the door frame at three points with no need to lift the handleset lever. An integrated mishandling device protects the door and frame from accidental damage. Features deadbolt located above handleset.

(Highly recommended for 8'0" fiberglass doors. Not recommended for steel doors. Strike plate package available. Active option only.)

### Standard Door MPLS



**Tongue**  
(For single door systems.)  
**Heights:** 6'8"  
 7'0"  
 8'0"  
**Configurations:**  
 Inswing  
 Outswing

- ① Self-lubricating locks.
- ② 1" premium stainless steel deadbolt.
- ③ Integrated mishandling device.

### Key

Tru-Defense Eligible

Side view of door.

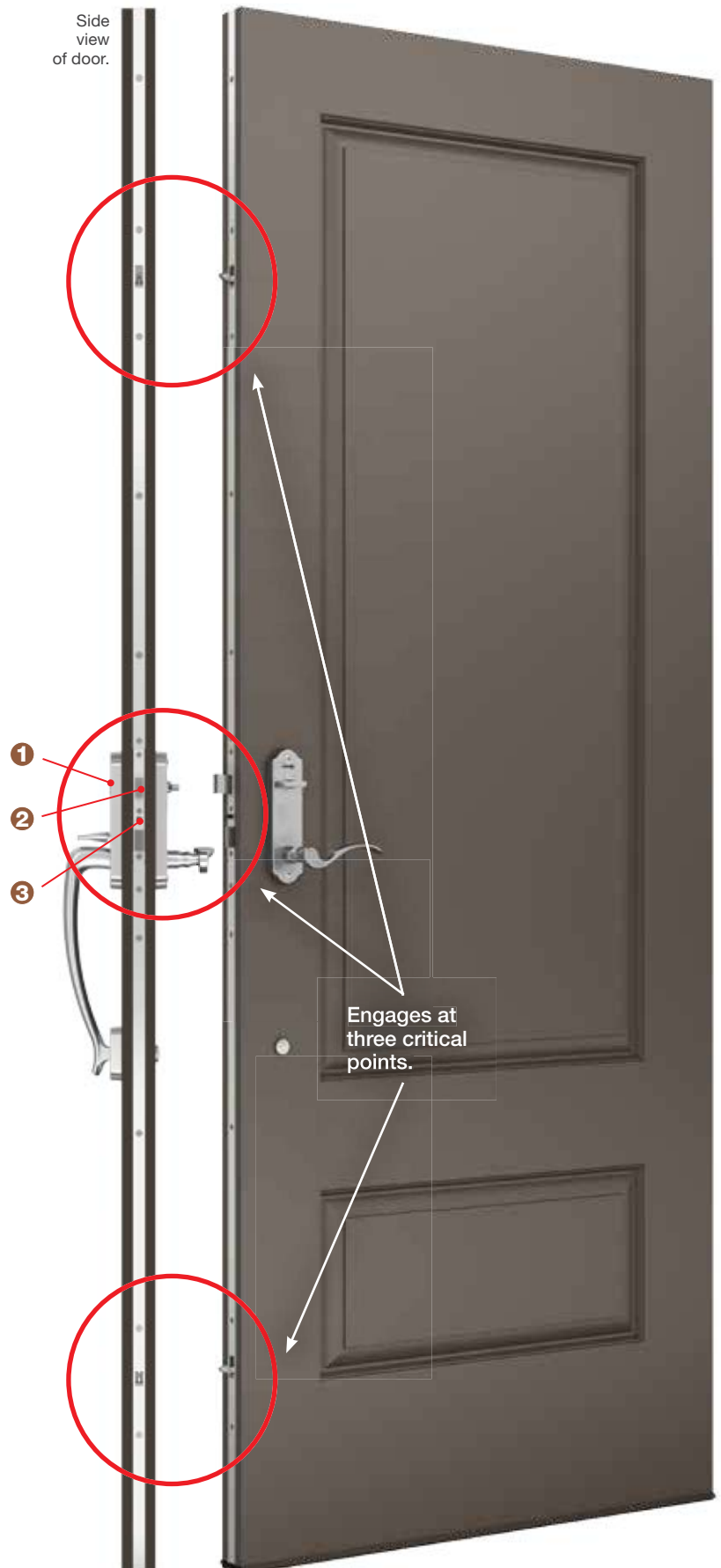

Interior view of door.





Side view of door.

Engages at three critical points.

Exterior view of door.

### Lever-Style MPLS

Lever-style handlesets bring form and function together with decorative styles. A convenient upward turn of the handle is required before all three points will engage. An integrated mishandling device helps protect the door and frame from accidental damage. Features deadbolt below the handleset.

(Highly recommended for 8'0" and double fiberglass doors. Not recommended for steel doors. Strike plate packages available to meet the installation needs of various MPLS applications.)

### Standard Door MPLS



#### Tongue

(For single door systems.)

| Heights: | Configurations: |
|----------|-----------------|
| 6'6"     | Inswing         |
| 6'8"     | Outswing        |
| 7'0"     |                 |
| 8'0"     |                 |



#### Shootbolt

(For double door systems.)

| Heights: | Configurations: |
|----------|-----------------|
| 6'6"     | Inswing         |
| 6'8"     | Outswing        |
| 7'0"     |                 |
| 8'0"     |                 |

### Vented Sidelite MPLS



#### Tongue

(Included in vented sidelite units.)

| Heights: |
|----------|
| 6'6"     |
| 6'8"     |
| 8'0"     |

# Handleset Options for Standard Door MPLS

Designed to complement Thermo-Tru door styles from traditional to contemporary.

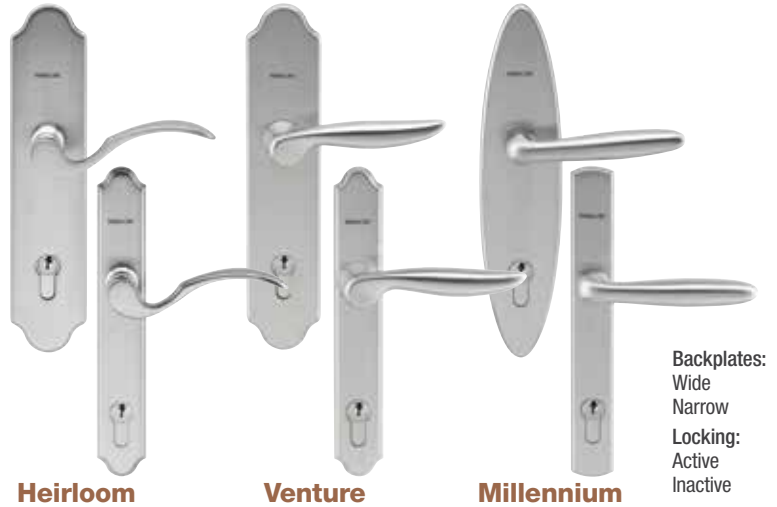

## Finish Options for Handlesets & Hinges



Bright Brass    Antique Brass\*    Brushed Nickel    Black Nickel    Polished Chrome\*    Oil-Rubbed Bronze

\*Not available for Forte and Prospect handlesets.

## Hinges & Strike Plate

| Hinge Finish Options | Hinges     |                            |                            |               |                                       |              |               | Adjustable Security Strike Plate (For Latch & Deadbolt) |
|----------------------|------------|----------------------------|----------------------------|---------------|---------------------------------------|--------------|---------------|---|
|                      | Adjustable | Classic-Craft Ball-Bearing | Self-Aligning Ball-Bearing | Self-Aligning | Self-Aligning NRP (Non-Removable Pin) | Security Tab | Spring-Loaded |   |
| Bright Brass         | ■          | ■                          | ■                          | ●             | ●                                     | ●            | ●             | ●   |
| Antique Brass        | ■          | ■                          | ■                          | ●             | ●                                     | ●            | ●             | ■   |
| Brushed Nickel       | ■          | ■                          | ■                          | ■             | ■                                     | ■            | ■             | ■   |
| Black Nickel         | ■          | ■                          | ■                          | ●             | ■                                     | ●            | ■             | ■   |
| Polished Chrome      | ■          | ■                          | ■                          | ●             | ■                                     | ●            | ■             | ■   |
| Oil-Rubbed Bronze    | ■          | ■                          | ■                          | ■             | ■                                     | ●            | ■             | ■   |
| Stainless Steel      | ●          | ■                          | ■                          | ●             | ■                                     | ■            | ■             | ■   |
| Zinc Dichromate      | ●          | ■                          | ■                          | ■             | ■                                     | ■            | ■             | ■   |

Hinges position the door to properly compress the weatherstrip and help ensure smooth operation. Features options to suit various applications and mate with mortise pockets machined into our doors. Adjustable security strike plate wraps around the jamb and engages the frame for added support and strength, and resistance against forced entry.

# Astragals

Cover the margin between double doors to help complete the seal against air and moisture infiltration, with aluminum construction for stability, holding power and durability. Available in a stainable wood-grained vinyl wrap or paintable aluminum.



Available with strike plates to receive a latch and deadbolt or multi-point locking system.

Integrated weatherstrip helps form a tight seal between the astragal and active door when closed.

Durable boot engineered to work with the active bottom sweep to complete the seal across the sill.

16-1/2" locking steel slide bolt can be vertically adjusted for a secure fit with the sill and frame.



## Stainable Astragal

- Heights:**  
6'6"  
6'8"  
7'0"  
8'0"
- Width:**  
7/8"
- Configurations:**  
Inswing  
Outswing  
Multi-Point Lock  
Double Bore  
Left-Handed  
Right-Handed
- Grain Options:**  
Oak  
Mahogany  
Fir
- Weatherstrip:**  
Bronze

Shown in Oak grain with Mahogany stain.



## Aluminum Astragal

- Heights:**  
6'6"  
6'8"  
7'0"  
8'0"
- Width:**  
7/8"
- Configurations:**  
Inswing  
Outswing  
Multi-Point Lock  
Double Bore  
Left-Handed  
Right-Handed
- Finish Colors:**  
Bronze  
White
- Weatherstrip:**  
Bronze

Coastal option also available.

## Textures Available

Stainable (Shown in Natural Oak stain.)

Aluminum



Oak Grain

Mahogany Grain

Fir Grain

Bronze

White



## SAME-DAY STAIN

Finish with the same stain as the doors. Kit available in seven finish colors on pages 264–265.

Note: Finish colors may vary from an actual application due to fluctuations in finishing or printing. See page 273 for important product details that may help with your purchase decision.

Bottom: Classic-Craft Rustic Collection, Provincial Glass, Doors – CCR804028

## Key

Tru-Defense Eligible

# SAME-DAY® STAIN

**Create the authentic look of real wood in just a few simple steps.**

- Achieve professional-looking results with an easy-to-use, quick-drying formula.
- Colorfast stain resists fading, bleaching and yellowing to create a beautiful finish.
- Finish colors can be applied in a variety of shades to complement multiple home styles.
- Specially formulated for Therma-Tru® fiberglass doors.

## All-Inclusive Kit

Contains everything needed to stain a Therma-Tru fiberglass double door system or a single door with two sidelites.\*



Watch easy-to-follow instructions at [www.samedaystain.com](http://www.samedaystain.com).



\*Actual coverage may vary based on product selected, application method and desired appearance.

**5 YEAR LIMITED WARRANTY**

For Therma-Tru fiberglass doors. For complete details on the Same-Day Stain and topcoat limited warranty, go to [www.samedaystain.com](http://www.samedaystain.com) or ask your seller for more details.

## Classic-Craft® American Style Collection™

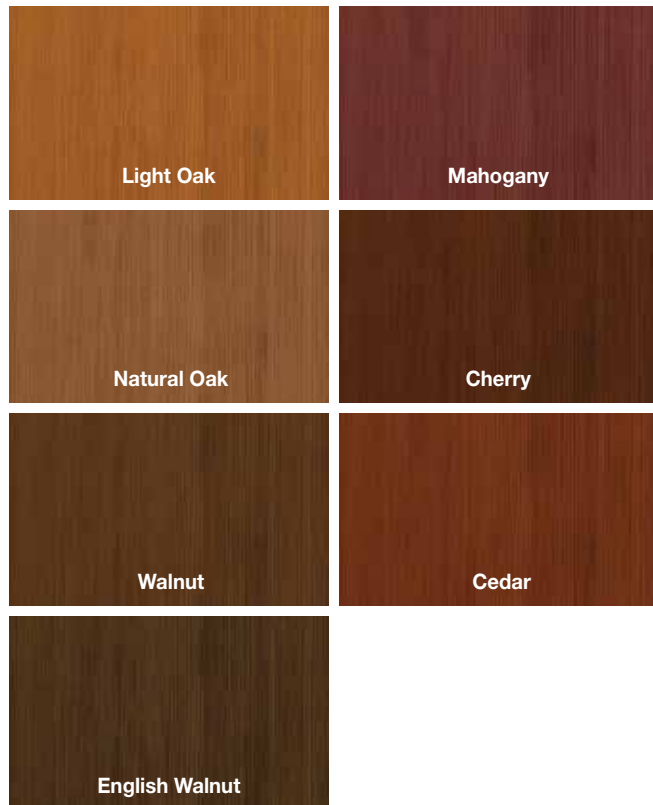

## Classic-Craft® Mahogany Collection™

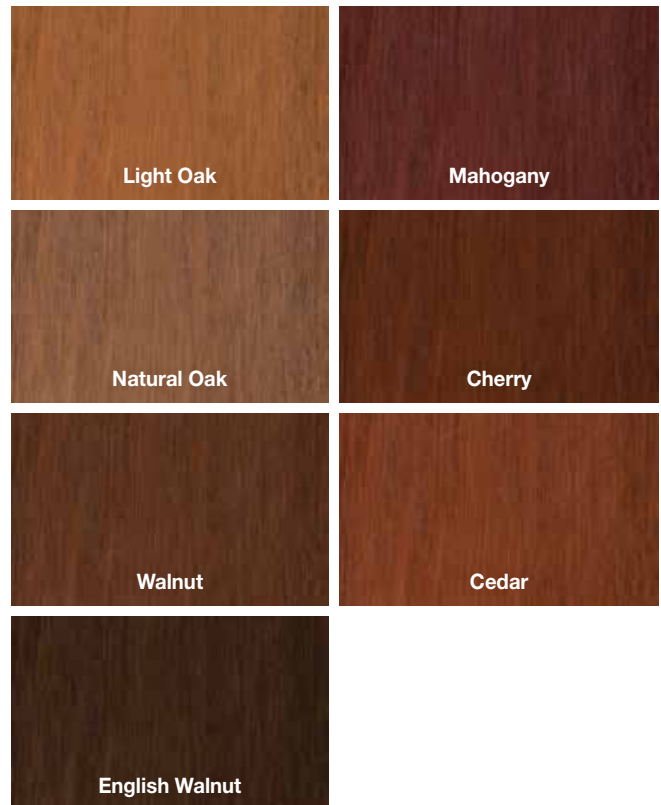

Note: Finish colors may vary from an actual application due to fluctuations in finishing or printing. See page 273 for important product details that may help with your purchase decision.



### Classic-Craft® Rustic Collection™



### Classic-Craft® Oak Collection™

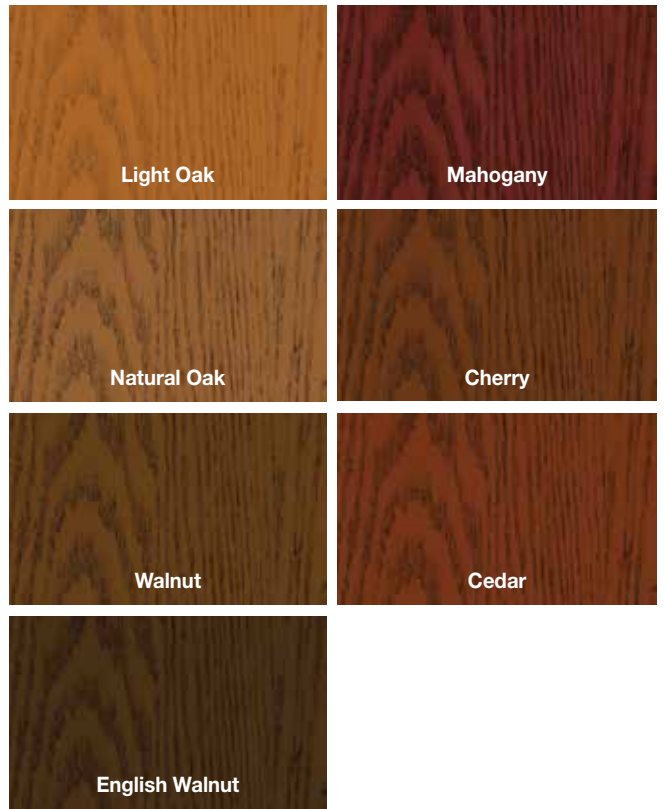

### Fiber-Classic® Mahogany Collection™

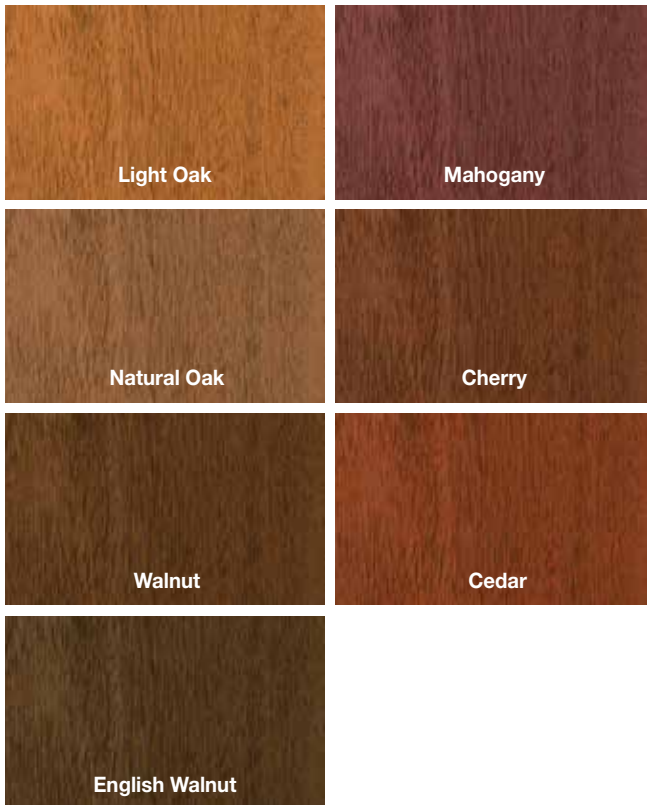

### Fiber-Classic® Oak Collection™



# Special Quote Program

Don't sacrifice the look you want. In addition to thousands of standard glass choices, we offer additional glass options through our Special Quote Program to help you find the right look for virtually any home.



## Privacy & Textured Glass

Achieve the desired look and level of privacy with additional options, including hammered glass doorlites shown above.



Special Quote SDL Pattern Example

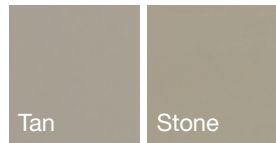

Special  
Quote  
GBG  
Color  
Options

## Divided Lites

Match various window patterns and home styles with additional grid patterns and color options.



Texas Star with Standard Brushed Nickel Caming



Texas Star with Special Quote Black Nickel Caming

## Caming Colors

Pair black nickel, brushed nickel or brass caming with any decorative glass design to complement home hardware and fixtures.





Top: Classic-Craft Mahogany Collection Door – CCM890, Sidelites – CCM8000SL  
Bottom Left: Fiber-Classic Mahogany, Saratoga Glass, Door – FCM905  
Bottom Right: Smooth-Star, Clear Glass with GBGs, Door – S2106





Top: Classic-Craft Rustic Collection Door – CCR8222; Low-E Glass, Sidelites – CCR8000SL  
Bottom Left: Pulse Ari, Satin Etch Glass with Flat Lite Frame, Door – S83XE  
Bottom Right: Classic-Craft Rustic Collection Door – CCR100, Strap Hinges



# 3'6" Width Door Style Options

## Classic-Craft®

Door Styles

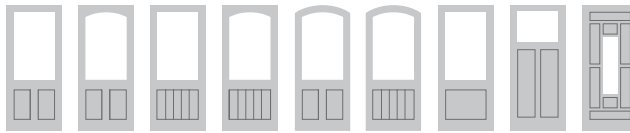

Glass Designs

|             |   |   |   |   |   |   |   |   |   |
|-------------|---|---|---|---|---|---|---|---|---|
| Homeward™   | ◆ |   | ◆ |   |   |   | ◆ | ■ |   |
| Augustine®  | ◆ | ◆ | ◆ | ◆ | ◆ | ◆ | ◆ |   |   |
| Arborwatch® | ◆ |   | ◆ |   |   |   | ◆ | ■ |   |
| Borrassa®   | ◆ | ◆ | ◆ | ◆ | ◆ | ◆ | ◆ |   |   |
| Lucerna®    | ◆ |   | ◆ |   |   |   | ◆ |   |   |
| Rainglass   | ◆ |   | ◆ |   |   |   | ◆ | ■ |   |
| Low-E       | ◆ |   | ◆ |   |   |   | ◆ | ■ | ▲ |

## Key

- Classic-Craft® American Style Collection™
- ◆ Classic-Craft® Rustic Collection™
- ▲ Classic-Craft® Oak Collection™
- \* Smooth-Star®
- Profiles™ & Traditions

## Solid-Panel Door Styles

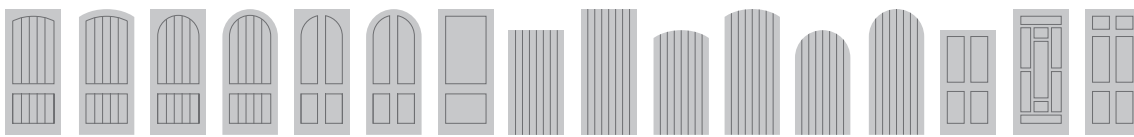

|   |   |   |   |   |   |   |   |   |   |   |   |   |   |   |   |   |   |
|---|---|---|---|---|---|---|---|---|---|---|---|---|---|---|---|---|---|
| ◆ | ◆ | ◆ | ◆ | ◆ | ◆ | ◆ | ◆ | ◆ | ◆ | ◆ | ◆ | ◆ | ◆ | ◆ | ▲ | ▲ | ▲ |
|---|---|---|---|---|---|---|---|---|---|---|---|---|---|---|---|---|---|

## Smooth-Star®, Profiles™, Traditions & Pulse®

Door Styles

















All Pulse Styles









Glass Designs

|                          |     |   |     |     |   |     |   |     |   |     |   |     |   |     |   |  |
|--------------------------|-----|---|-----|-----|---|-----|---|-----|---|-----|---|-----|---|-----|---|--|
| Blackstone®              | * ▸ | * |     |     |   | * ▸ | * |     |   |     |   |     |   |     |   |  |
| Crystalline™             | * ▸ | * |     |     |   | * ▸ | * |     |   |     |   |     |   |     |   |  |
| Sedona                   | * ▸ |   |     |     |   | * ▸ | * |     |   |     |   |     |   |     |   |  |
| Salinas®                 | * ▸ | * |     |     |   | * ▸ | * |     |   |     |   |     |   |     |   |  |
| Maple Park®              | * ▸ |   |     |     |   | * ▸ |   |     |   |     |   |     |   |     |   |  |
| Avonlea®                 | * ▸ |   |     |     |   | * ▸ |   |     |   |     |   |     |   |     |   |  |
| Saratoga™                | * ▸ |   |     |     |   | * ▸ | * |     |   |     |   |     |   |     |   |  |
| Texas Star               | * ▸ |   |     |     |   | * ▸ |   |     |   |     |   |     |   |     |   |  |
| Wellesley™               | * ▸ | * |     |     |   |     |   |     |   |     |   |     |   |     |   |  |
| Riserva™                 | * ▸ | * |     | * ▸ | * | * ▸ | * |     |   |     |   |     |   |     |   |  |
| Concorde™                | * ▸ | * | * ▸ |     |   |     |   |     |   |     |   |     |   |     |   |  |
| Kensington™              | * ▸ |   |     |     |   |     |   |     |   |     |   |     |   |     |   |  |
| Axis™                    | * ▸ | * |     | * ▸ | * | * ▸ | * | * ▸ | * | * ▸ | * | * ▸ | * |     |   |  |
| Frosted Images®          | * ▸ | * | * ▸ |     |   |     |   |     |   |     |   |     |   |     |   |  |
| Privacy & Textured Glass | * ▸ | * |     | * ▸ | * | * ▸ | * | * ▸ | * | * ▸ | * | * ▸ | * |     |   |  |
| Internal Blinds          | * ▸ | * |     |     |   | * ▸ | * |     |   |     |   |     |   |     |   |  |
| Divided Lites            | * ▸ | * |     |     |   |     |   |     |   |     |   |     |   |     |   |  |
| Clear                    | * ▸ | * | * ▸ | * ▸ | * | * ▸ | * | * ▸ | * | * ▸ | * | * ▸ | * |     |   |  |
| Solid Panel              |     |   |     |     |   |     |   |     |   |     |   |     |   | * ▸ | * |  |

## 7'0" Height Door Style Options







| Door Styles              |  |  |  |  |  |  |  |  |  |  |  |  |  |  |  |  |     |
|--------------------------|---|---|---|---|---|---|---|---|---|--|---|---|---|---|---|---|-----|
| Blackstone.              | ▼▲*   | ▲*▷   | *   |   |   |   | ▷   |   |   |  |   |   |   |   |   |   | ▼▲* |
| Crystalline™             | ▼▲*   | ▲*▷   | *   |   | ▷   | ▷   | ▷   |   |   |  |   | ▷   | ▲*▷   |   |   |   | ▼▲* |
| Sedona                   | ▼▲*   | ▲*▷   | *   |   |   | ▷   |   |   |   |  |   |   |   |   |   |   | ▼▲* |
| Salinas.                 | ▼▲*   | ▲*▷   | *   |   | ▷   | ▷   |   |   |   |  |   |   |   |   |   |   | ▼▲* |
| Maple Park.              | ▼▲*   | ▲*▷   | *   |   |   | ▷   |   |   |   |  | ▲*▷   |   |   |   |   |   | ▼▲* |
| Avonlea.                 | ▼▲*   | ▲*▷   | *   |   |   | ▷   |   |   |   |  |   |   |   |   |   |   | ▼▲* |
| Saratoga™                | ▼▲*   | ▲*▷   | *   |   |   | ▷   |   |   |   |  | ▲*▷   |   |   |   |   |   | ▼▲* |
| Texas Star               | ▼▲*   | ▲*▷   | *   |   |   | ▷   |   |   |   |  |   |   |   |   |   |   | ▼▲* |
| Wellesley™               | ▼▲*   | ▲*▷   | *   |   |   | ▷   |   |   |   |  | ▲*▷   |   |   |   |   |   | ▼▲* |
| Riserva™                 | ▼▲*   | ▲*▷   | *   |   |   | ▷   |   |   |   |  |   |   |   |   |   |   | ▼▲* |
| Concorde™                | ▼▲*   | ▲*▷   | *   |   | ▷   | ▷   | ▷   | *▷  |   | ▲*▷  | ▷   |   |   |   |   |   | ▼▲* |
| Kensington™              | ▼▲*   | ▲*▷   | *   |   |   | ▷   |   |   |   |  |   |   |   |   |   |   | ▼▲* |
| Axis™                    | ▼▲*   | ▲*▷   | *   |   |   | ▷   |   |   |   |  |   |   | ▲*▷   |   |   |   | ▼▲* |
| Frosted Images.          | ▼▲*   | ▲*▷   | *   |   | ▷   | ▷   | ▷   | *▷  |   |  | ▷   |   |   |   |   |   | ▼▲* |
| Privacy & Textured Glass | ▼▲*   | ▲*▷   | *   | ▼▲*   |   | ▷   |   |   |   | ▲*▷  | ▷   | ▲*▷   |   |   |   |   | ▼▲* |
| Internal Blinds          | ▼▲*   | ▲*▷   | *   | ▼▲*   |   |   |   |   |   |  |   |   |   |   |   |   | ▼▲* |
| Screen Vented            |   | *▷  | *   | *▷  |   |   |   |   |   |  |   |   |   |   |   |   |     |
| Divided Lites            | ▼▲*   | ▲*▷   | *   |   | ▷   | ▷   | ▷   |   | *▷  | ▲*▷  | ▷   |   |   | ▷   | ▷   |   | ▼▲* |
| Clear                    | ▼▲*   | ▲*▷   | *   | ▼▲*   | ▷   | ▷   | ▷   | *▷  | *▷  | ▲*▷  | ▷   | ▲*▷   |   |   |   |   | ▼▲* |
| Solid Panel              |   |   |   |   |   |   |   |   |   |  |   |   |   |   |   |   |     |

## 6'6" Height Door Style Options

| Door Styles              |  |  |  |  |  |  |
|--------------------------|---|---|---|---|---|---|
| Blackstone.              | ▼▲*   |   |   |   | ▼▲*   |   |
| Crystalline™             | ▼▲*   |   |   |   | ▼▲*   |   |
| Sedona                   | ▼▲*   |   |   |   | ▼▲*   |   |
| Salinas.                 | ▼▲*   |   |   |   | ▼▲*   |   |
| Maple Park.              | ▼▲*   |   |   |   | ▼▲*   |   |
| Avonlea.                 | ▼▲*   |   |   |   | ▼▲*   |   |
| Saratoga™                | ▼▲*   |   |   |   | ▼▲*   |   |
| Texas Star               | ▼▲*   |   |   |   | ▼▲*   |   |
| Wellesley™               | ▼▲*   |   |   |   | ▼▲*   |   |
| Riserva™                 | ▼▲*   |   |   |   | ▼▲*   |   |
| Concorde™                | ▼▲*   |   | *▷  |   | ▼▲*   |   |
| Kensington™              | ▼▲*   |   |   |   | ▼▲*   |   |
| Axis™                    | ▼▲*   |   |   |   | ▼▲*   |   |
| Frosted Images.          | ▼▲*   |   | *▷  |   | ▼▲*   |   |
| Privacy & Textured Glass | ▼▲*   | ▷   |   |   | ▼▲*   |   |
| Internal Blinds          | ▼▲*   | ▷   |   |   | ▼▲*   |   |
| Screen Vented            |   | ▷   |   |   |   |   |
| Divided Lites            | ▼▲*   |   |   | ▷   | ▼▲*   |   |
| Clear                    | ▼▲*   | ▷   | *▷  | ▷   | ▼▲*   |   |
| Solid Panel              |   |   |   |   |   | ▼▲*   |

### Key

- ▼ Fiber-Classic® Mahogany Collection™
- ▲ Fiber-Classic® Oak Collection™
- \* Smooth-Star®
- ▷ Profiles™ & Traditions
- Steel Edge

|  |  |  |  |  |  |  |  |
|--|---|---|---|---|---|---|---|
|  | ▶   |   |   |   |   |   |   |
|  | ▶   | ▶   | ▶   |   |   |   |   |
|  | ▶   |   |   |   |   |   |   |
|  | ▶   |   |   |   |   |   |   |
|  | ▶   |   |   |   |   |   |   |
|  | ▶   |   |   |   |   |   |   |
|  | ▶   |   |   |   |   |   |   |
|  | ▶   |   |   |   |   |   |   |
|  | ▶   | ▶   |   |   |   |   |   |
|  | ▶   |   |   |   |   |   |   |
|  | ▶   | ▶   | ▶   |   |   |   |   |
|  | ▶   |   | ▶   |   |   |   |   |
|  | ▶   |   |   |   |   |   |   |
|  | ▶   | ▶   |   |   |   |   |   |
|  | ▶   | ▶   | ▶   |   |   |   |   |
|  |   |   |   | ■*  | ■   | ■▲*   | ■▼▲*  |



Bottom: Smooth-Star Door – SSF220

## Entry &amp; Patio Door Systems

| Feature   | Classic-Craft.  | Fiber-Classic.<br>& Pulse.<br>Wood-Grained                          | Smooth-Star. &<br>Pulse. Smooth                                     | Profiles™ &<br>Pulse. Steel (6'8")                                 | Traditions &<br>Pulse. Steel (8'0")                                |
|---|---|---|---|--|--|
| <b>Skin Material</b>  | Fiberglass  | Fiberglass  | Fiberglass  | 24-Gauge Steel   | 6'8": 25-Gauge Steel / 8'0": 24-Gauge Steel                        |
| <b>Skin Texture</b>   | Oak, Mahogany, Fir Grain; High-Detail Smooth                  | Oak, Mahogany Grain   | High-Detail Smooth  | Smooth   | Smooth   |
| <b>Exterior Finish</b>  | Stain or Paint  | Stain or Paint  | Paint   | Paint  | Paint  |
| <b>Interior Finish</b>  | Stain or Paint  | Stain or Paint  | Paint   | Paint  | Paint  |
| <b>Panel – Top Rail</b>   | Composite   | Composite   | Composite   | Wood   | Wood   |
| <b>Panel – Bottom Rail</b>  | Composite   | Composite   | Composite   | Composite  | Composite  |
| <b>Lock Stile</b>   | 4-1/8" Full-Length Engineered Lumber Stile                    | 1-1/4" Engineered Lumber  | 1-1/4" Engineered Lumber  | 1-1/4" Wood  | 1-1/4" Wood  |
| <b>Lock Block</b>   | 4-1/8" Full-Length Engineered Lumber Stile                    | 22-1/2" Wood  | 12-1/2" Wood  | 12-1/2" Wood   | 6'8": 12-1/2" Wood / 8'0": 22-1/2" Wood                            |
| <b>Height Options</b>   | 6'8" & 8'0"   | 6'6", 6'8", 7'0" & 8'0"   | 6'6", 6'8", 7'0" & 8'0"   | 6'6", 6'8" & 7'0"  | 6'6", 6'8" & 8'0"  |
| <b>Width Options</b>  | 2'8", 3'0" & 3'6"   | 2'0", 2'4", 2'6", 2'8", 2'10" & 3'0"                                | 2'0", 2'4", 2'6", 2'8", 2'10", 3'0" & 3'6"                          | 2'0", 2'4", 2'6", 2'8", 2'10", 3'0" & 3'6"                         | 2'0", 2'4", 2'6", 2'8", 2'10" & 3'0"                               |
| <b>Panel Options</b>  | Single, Double or Triple                                      | Single, Double or Triple  | Single, Double or Triple  | Single, Double or Triple   | Single, Double or Triple   |
| <b>Sidelite Options</b>   | 10", 12" & 14"  | 10", 12" & 14"  | 10", 12" & 14"  | 10", 12" & 14"   | 10", 12" & 14"   |
| <b>Glass Options</b>  | SMC Frame; Deco / Privacy & Textured / Low-E IG               | BTS Frame, PVC Frame; Deco / Privacy & Textured / Low-E / Clear IG  | BTS Frame, PVC Frame; Deco / Privacy & Textured / Low-E / Clear IG  | BTS Frame, PVC Frame; Deco / Privacy & Textured / Low-E / Clear IG | BTS Frame, PVC Frame; Deco / Privacy & Textured / Low-E / Clear IG |
| <b>Sill*</b>  | Inswing: Composite Adjustable<br>Outswing: Composite Outswing | Inswing: Basic Composite Adjustable<br>Outswing: Composite Outswing | Inswing: Basic Composite Adjustable<br>Outswing: Composite Outswing | Inswing: Basic Fixed<br>Outswing: Aluminum                         | Inswing: Basic Fixed<br>Outswing: Aluminum                         |
| <b>Weatherstrip – Hinge</b>   | Medium-Reach  | Medium-Reach  | Medium-Reach  | Medium-Reach   | Medium-Reach   |
| <b>Weatherstrip – Lock</b>  | Medium-Reach  | Long-Reach  | Long-Reach  | Long-Reach or Magnetic   | Long-Reach or Magnetic   |
| <b>Weatherstrip – Head</b>  | Medium-Reach  | Long-Reach  | Long-Reach  | Long-Reach or Magnetic   | Long-Reach or Magnetic   |
| <b>Multi-Point Lock</b>   | Recommended   | Recommended   | Recommended   | –  | –  |
| <b>Security Strike Plate</b>  | Recommended   | Recommended   | Recommended   | Recommended  | Recommended  |
| <b>Hinges*</b>  | Classic-Craft Ball-Bearing                                    | Self-Aligning   | Self-Aligning   | Self-Aligning  | Self-Aligning  |
| <b>Frame*</b>   | Rot-Resistant   | Rot-Resistant   | Rot-Resistant   | Primed Pine  | Primed Pine  |
| <b>Screens &amp; Screen Accessories Available</b><br>Colors: Bronze, Stone, White | 2" Frame, 3" Frame  | 2" Frame, 3" Frame  | 2" Frame, 3" Frame  | 2" Frame, 3" Frame   | 2" Frame, 3" Frame   |
| <b>Residential Limited Warranty</b>   | Lifetime  | Lifetime  | Lifetime  | 10 Years   | Door: 5 Years / Glass: 10 Years / Pulse 8'0": 10 Years             |

For dimensional data, see your Therma-Tru seller or visit [www.thermatru.com](http://www.thermatru.com) for a copy of the Therma-Tru Unit & Rough Opening Sizing Booklet.

\*Standard product recommendations shown; additional options may be available.



# Therma-Tru® Door Systems

## Independent Laboratory Performance Testing

At the time of manufacture, Therma-Tru exterior door systems (properly assembled with all genuine Therma-Tru components) have been tested under one or more of the following performance specifications: structural load, uniform load deflection, vertical load resistance, air infiltration, water penetration resistance, forced entry resistance, operating forces, force to latch, deglazing resistance, operating cycle performance, impact resistance, sound transmission, thermal performance and solar heat gain performance. Therma-Tru exterior door systems conform to the applicable Performance Standards / Test Methods that may include ANSI/AAMA/NWDDA 101/I.S.2, AAMA/WDMA 101/I.S.2/NAFS, AAMA/WDMA/CSA 101/I.S.2-A440, ASTM E330, ASTM E547, ASTM E283, ASTM E 331, ANSI/BHMA A156.2, AAMA 1304, AAMA 920, AAMA 925, ASTM E2068, ASTM F842, ASTM E987, ASTM E1300, ASTM E90, ASTM E413, ASTM E1332, ASTM E1886, ASTM E1996, PA/TAS 201, PA/TAS 202, PA/TAS 203, HUD UM89, AAMA 1702.2, 24 CFR 3280, 24 CFR 3282, NFRC 100 and NFRC 200. Refer to [www.thermatru.com](http://www.thermatru.com) for design pressure and other performance ratings.

## Doors

**Recommended Door Overhang** – For best performance, all doors should be protected by an overhang. The recommended size is half the distance from the base of the door to the bottom of the overhang. So, as an example, a distance of 10' for this dimension would require an overhang of 5' minimum. For wetter climates, southern or western exposures, and for double doors, the overhang should be the same as the distance from the base of the door to the bottom of the overhang. In this same example, the dimension is 10' so the overhang should be 10'.

For best performance, double doors to be used in areas with severe weather exposure must be installed using entry alcoves or large soffit overhangs to protect entry unit from exposure. Multi-point locking systems are highly recommended for 8'0" and double door applications.

## Doorlites

Doorlites are insulated, and exposed panes are tempered. Optional wood grilles available for clear doorlites and transoms.

**Inserts** – All glass (except flush-glazed styles) shall be bedded with glazing mastic and secured in doors with screws. Therma-Tru's SMC and BTS doorlite frames are available for most styles except where noted. SMC and BTS frames shall resist significant deformation by heat up to 200 degrees Fahrenheit, regardless of paint or stain color or placement behind a storm door.

PVC doorlite frames and dividers must be finished within 30 days of installation. Failure to do so will increase the chance for product damage of the type that is not covered by the warranty. PVC doorlite frames and dividers are not recommended for use behind storm doors or to be painted dark colors, if exposed to direct sunlight.

**Decorative Glass & Wrought Iron** – Each Therma-Tru decorative glass unit is handcrafted by skilled artisans replicating Old World techniques. Each piece is a unique work of art and many things that would appear to be imperfections (small bubbles, lines and waves within the glass) are normal and are part of the Old World charm.

Condensation occurs naturally in the home, caused by excessive humidity in the air. Often this harmless water vapor can be seen collecting on glass surfaces, such as doorlites. Energy-efficient glass units in Therma-Tru door systems are constructed to keep the glass as warm as possible, reducing condensation build-up. However, there is no such thing as a condensation-free window or doorlite in high-humidity conditions.

**NOTE: Glass privacy ratings are determined by the 1/2-lite glass size. As a result, the amount of privacy / glass transparency may be more or less than indicated by the privacy rating, based on the glass design and size of the glass that is inserted into the door, sidelite or transom.**

Glass designs may differ from depiction due to the size and hand craftsmanship of glass. See your Therma-Tru seller or visit [www.thermatru.com](http://www.thermatru.com) for more details.

## Components

**Adjustable Security Strike Plate** – Proprietary adjustable type, permitting in-out adjustment of door in frame, up to 3/16".

**Hinges** – Minimum hinge size 4" x 4" x .098".

Ball-bearing hinges are recommended for 8'0" doors, doors using heavy lites (e.g., wrought iron), all 20-Minute Fire-rated fiberglass doors, Impact-rated doors and glass, and all Classic-Craft doors.

Use of the multi-point locking system is highly recommended for 8'0" and double fiberglass doors. Not recommended for steel doors.

Please be aware that single door units built with public access sills have little resistance to water penetration, and double doors built with these sills have a potential to leak if installed exposed to weather. We recommend that units be installed away from weather under large soffits or overhangs.

Use of a sill pan is recommended.

Fiber-Classic and Smooth-Star dentil shelves are not recommended for placement behind storm doors or to be painted dark colors, if exposed to direct sunlight.

## Impact-Rated Products

Impact-rated products must be installed as part of a Therma-Tru door system in compliance with a Therma-Tru product approval. Visit [www.thermatru.com](http://www.thermatru.com) for product approvals and full details on WBDR- (Wind-Borne Debris Region) / HVHZ- (High Velocity Hurricane Zone) compliant products. Follow weather and news reports in order to assess severe weather situations and obey local authorities' shelter and evacuation orders. No product guarantees safety for persons or property, nor makes any premises hurricane- or impact-proof.

## Fire-Rating Performance Standards

Fire and building codes vary throughout the country and acceptance of products and labels is left to the discretion of the local authorities.

MODIFICATION OF PRODUCTS DESCRIBED IN THIS BROCHURE WHICH CARRY FIRE RATINGS (DOORS AND FRAMES) MAY VOID THE FIRE RATINGS.

Test conducted by Intertek, Warnock-Hersey.

## Limited Warranties

Please be aware of the applicable Therma-Tru Limited Warranty which contains important restrictions, disclaimers, exclusions and conditions, as well as the below listed Installation, Finishing & Maintenance documents, related to the Therma-Tru product purchased (e.g., Fiberglass, Steel, Patio Door Systems), all of which can be obtained from your Therma-Tru seller or found in their entirety at [www.thermatru.com](http://www.thermatru.com):

- Therma-Tru. Fiberglass and Steel Door Systems Residential Limited Warranty: Fiberglass – Classic-Craft, Fiber-Classic, Smooth-Star. and Pulse. Door Systems; Steel – Pulse, Profiles, Traditions and Therma-Tru. Fire Door (TR 12-24) Steel Edge Door Systems
- Therma-Tru. Tru-Defense. Door System Rider to Fiberglass Door Systems Limited Warranty: Classic-Craft, Fiber-Classic, Smooth-Star and Pulse. Fiberglass Door Systems
- Therma-Tru. Construction Glass Breakage Rider to Fiberglass Door Systems Limited Warranty for Residential and Multi-Resident Premises: Classic-Craft, Fiber-Classic, and Smooth-Star. Flush-Glazed Fiberglass Door Systems
- Same-Day. Stain 5-Year Limited Warranty: Same-Day. Stain and Topcoat for Use on Therma-Tru. Fiberglass Door Systems and Fypon. Stainable Polyurethane Products

## Installation, Finishing & Maintenance

Installation, finishing and maintenance must be performed according to Therma-Tru's recommendations to comply with warranty requirements. Obtain a copy of the following documents outlining recommendations from your Therma-Tru seller or find them in their entirety at [www.thermatru.com](http://www.thermatru.com):

- Installation Instructions
- Therma-Tru Fiberglass and Steel Door Systems Recommendations for Proper Finishing and Painting or Staining

**NOTE: Finish colors may vary from an actual application due to fluctuations in finishing or the printing of this catalog. See your Therma-Tru seller or visit [www.thermatru.com](http://www.thermatru.com) for more details.**



**Therma-Tru. Owner's Manual & Warranties**

[www.thermatru.com/warranty](http://www.thermatru.com/warranty)

## Classic-Craft.

**American Style  
Collection.**

|                  |    |                  |    |                   |    |                  |    |                 |    |                  |    |
|------------------|----|------------------|----|-------------------|----|------------------|----|-----------------|----|------------------|----|
| 19200T.....      | 51 | CCA3560XRSL..... | 50 | BEET-B.....       | 59 | CCM3510BSL.....  | 59 | HWRT.....       | 56 | CCR1838.....     | 76 |
| 19220T.....      | 51 | CCA81423SL.....  | 49 | BERT-B.....       | 59 | CCM400.....      | 62 | LC30T.....      | 61 | CCR1839.....     | 76 |
| AB30T.....       | 49 | CCA8210.....     | 51 | CC060T.....       | 57 | CCM403.....      | 60 | LCET.....       | 61 | CCR1841.....     | 76 |
| ABRT.....        | 49 | CCA8210XC.....   | 50 | CC600T.....       | 57 | CCM405.....      | 58 | LCHRT.....      | 61 | CCR1851.....     | 76 |
| CCA1423SL.....   | 49 | CCA8210XJ.....   | 50 | CC620T.....       | 57 | CCM409.....      | 57 | LCRT.....       | 61 | CCR1851SL.....   | 76 |
| CCA210.....      | 51 | CCA8210XN.....   | 50 | CCM100.....       | 62 | CCM500.....      | 62 | LF30T.....      | 60 | CCR200.....      | 79 |
| CCA210SL.....    | 51 | CCA8210XR.....   | 50 | CCM10022.....     | 61 | CCM503.....      | 60 | LFET.....       | 60 | CCR20020.....    | 78 |
| CCA210XC.....    | 50 | CCA8211.....     | 48 | CCM100XC.....     | 61 | CCM505.....      | 58 | LFHRT.....      | 60 | CCR20020XC.....  | 77 |
| CCA210XCSSL..... | 50 | CCA8212.....     | 48 | CCM100XJ.....     | 61 | CCM509.....      | 57 | LFRT.....       | 60 | CCR20020XJ.....  | 77 |
| CCA210XJ.....    | 50 | CCA8220.....     | 51 | CCM100XN.....     | 61 | CCM600.....      | 62 | VG30T.....      | 56 | CCR20020XN.....  | 77 |
| CCA210XJSL.....  | 50 | CCA8220XC.....   | 50 | CCM100XR.....     | 61 | CCM600.....      | 62 | VGRT.....       | 56 | CCR20020XR.....  | 77 |
| CCA210XN.....    | 50 | CCA8220XJ.....   | 50 | CCM103.....       | 60 | CCM603.....      | 60 | ZHHRT.....      | 60 | CCR20022.....    | 76 |
| CCA210XNSL.....  | 50 | CCA8220XN.....   | 50 | CCM105.....       | 58 | CCM605.....      | 58 | ZHRT.....       | 60 | CCR20023.....    | 75 |
| CCA210XR.....    | 50 | CCA8220XR.....   | 50 | CCM109.....       | 57 | CCM609.....      | 57 |                 |    | CCR20024B.....   | 72 |
| CCA210XRSL.....  | 50 | CCA8221.....     | 48 | CCM110B.....      | 58 | CCM610B.....     | 58 |                 |    | CCR20025.....    | 71 |
| CCA211.....      | 48 | CCA8222.....     | 48 | CCM1419.....      | 59 | CCM612.....      | 61 | 19020T.....     | 78 | CCR20026.....    | 75 |
| CCA211SL.....    | 48 | CCA8230.....     | 51 | CCM1423.....      | 59 | CCM700.....      | 62 | 19200T.....     | 78 | CCR20027.....    | 70 |
| CCA212.....      | 48 | CCA8230XC.....   | 50 | CCM1423SL.....    | 59 | CCM701.....      | 62 | 19220T.....     | 78 | CCR20028.....    | 74 |
| CCA212SL.....    | 48 | CCA8230XJ.....   | 50 | CCM1424.....      | 59 | CCM702.....      | 61 | AB30T.....      | 72 | CCR20029.....    | 69 |
| CCA220.....      | 51 | CCA8230XN.....   | 50 | CCM1465.....      | 59 | CCM703.....      | 60 | ABRT.....       | 72 | CCR20037.....    | 70 |
| CCA220SL.....    | 51 | CCA8230XR.....   | 50 | CCM1475.....      | 59 | CCM705.....      | 58 | ARHRT.....      | 69 | CCR20037A.....   | 70 |
| CCA220XC.....    | 50 | CCA8231.....     | 48 | CCM1485.....      | 57 | CCM709.....      | 57 | AS30T.....      | 71 | CCR200A.....     | 79 |
| CCA220XCSSL..... | 50 | CCA8232.....     | 48 | CCM1495.....      | 57 | CCM710B.....     | 58 | ASET.....       | 71 | CCR205.....      | 79 |
| CCA220XJ.....    | 50 | CCA8240.....     | 51 | CCM1528.....      | 59 | CCM800.....      | 62 | ASHRT.....      | 71 | CCR20520.....    | 78 |
| CCA220XJSL.....  | 50 | CCA8240XC.....   | 50 | CCM1842.....      | 60 | CCM8000SL.....   | 62 | ASRT.....       | 71 | CCR20520XC.....  | 77 |
| CCA220XN.....    | 50 | CCA8240XJ.....   | 50 | CCM1843SL.....    | 60 | CCM8000XCSL..... | 61 | BEBHRT.....     | 72 | CCR20520XJ.....  | 77 |
| CCA220XNSL.....  | 50 | CCA8240XN.....   | 50 | CCM1844.....      | 60 | CCM8000XHSL..... | 59 | BEET-B.....     | 72 | CCR20520XN.....  | 77 |
| CCA220XR.....    | 50 | CCA8240XR.....   | 50 | CCM1851.....      | 60 | CCM8000XJSL..... | 61 | BERT-B.....     | 72 | CCR20520XR.....  | 77 |
| CCA220XRSL.....  | 50 | CCA8260.....     | 51 | CCM1851SL.....    | 60 | CCM8000XNSL..... | 57 | CBHRT.....      | 75 | CCR20522.....    | 76 |
| CCA221.....      | 48 | CCA8260XC.....   | 50 | CCM200.....       | 62 | CCM8000XRSL..... | 61 | CC060T.....     | 69 | CCR20523.....    | 75 |
| CCA222.....      | 48 | CCA8260XJ.....   | 50 | CCM200XC.....     | 61 | CCM8001SL.....   | 60 | CC090T.....     | 75 | CCR20524B.....   | 72 |
| CCA230.....      | 51 | CCA8260XN.....   | 50 | CCM200XJ.....     | 61 | CCM8002SL.....   | 58 | CC400T.....     | 74 | CCR20525.....    | 71 |
| CCA230XC.....    | 50 | CCA8260XR.....   | 50 | CCM200XN.....     | 61 | CCM8003SL.....   | 57 | CC420T.....     | 74 | CCR20526.....    | 75 |
| CCA230XJ.....    | 50 | CCA87100.....    | 51 | CCM200XR.....     | 61 | CCM8004BSL.....  | 59 | CC620T.....     | 69 | CCR20527.....    | 70 |
| CCA230XN.....    | 50 | CCA87111.....    | 49 | CCM203.....       | 60 | CCM801.....      | 62 | CC900T.....     | 75 | CCR20528.....    | 74 |
| CCA230XR.....    | 50 | CCA87112.....    | 48 | CCM204.....       | 61 | CCM803.....      | 60 | CC920T.....     | 75 | CCR20529.....    | 69 |
| CCA231.....      | 48 | CCA87121.....    | 49 | CCM205.....       | 58 | CCM805.....      | 58 | CC040T.....     | 74 | CCR20537.....    | 70 |
| CCA232.....      | 48 | CCA87122.....    | 48 | CCM209.....       | 57 | CCM805027.....   | 57 | CCR040.....     | 79 | CCR20537A.....   | 70 |
| CCA240.....      | 51 | CCA87131.....    | 49 | CCM210B.....      | 58 | CCM809.....      | 57 | CCR04020.....   | 78 | CCR205A.....     | 79 |
| CCA240XC.....    | 50 | CCA87132.....    | 48 | CCM300.....       | 62 | CCM8102SL.....   | 61 | CCR04020XC..... | 77 | CCR30020.....    | 78 |
| CCA240XJ.....    | 50 | CCA87200.....    | 51 | CCM30027.....     | 57 | CCM810B.....     | 58 | CCR04020XJ..... | 77 | CCR30020XC.....  | 77 |
| CCA240XN.....    | 50 | CCA87200XR.....  | 50 | CCM300XC.....     | 61 | CCM810B.....     | 58 | CCR04020XN..... | 77 | CCR30020XJ.....  | 77 |
| CCA240XR.....    | 50 | CCA87300.....    | 51 | CCM300XJ.....     | 61 | CCM81418.....    | 59 | CCR04020XR..... | 77 | CCR30020XN.....  | 77 |
| CCA260.....      | 51 | CCA87300XR.....  | 50 | CCM300XN.....     | 61 | CCM81423SL.....  | 59 | CCR04022.....   | 76 | CCR30020XR.....  | 77 |
| CCA260XC.....    | 50 | CCA87400.....    | 51 | CCM300XR.....     | 61 | CCM81519.....    | 59 | CCR04023.....   | 75 | CCR30023.....    | 75 |
| CCA260XJ.....    | 50 | CCA87400XR.....  | 50 | CCM302.....       | 61 | CCM81843.....    | 60 | CCR04024.....   | 72 | CCR30024B.....   | 72 |
| CCA260XN.....    | 50 | CCA87600.....    | 51 | CCM303.....       | 60 | CCM81851SL.....  | 60 | CCR04024B.....  | 72 | CCR30025.....    | 71 |
| CCA260XR.....    | 50 | CCA87600XR.....  | 50 | CCM305.....       | 58 | CCM822.....      | 61 | CCR04025.....   | 71 | CCR30026.....    | 75 |
| CCA260XSL.....   | 51 | CCA89100.....    | 49 | CCM309.....       | 57 | CCM890.....      | 62 | CCR04026.....   | 75 | CCR30027.....    | 70 |
| CCA3400SL.....   | 50 | CCA89200.....    | 49 | CCM310B.....      | 58 | CCM891.....      | 62 | CCR04027.....   | 70 | CCR30029.....    | 69 |
| CCA3400XCSL..... | 50 | CCA89300.....    | 49 | CCM3410BSL.....   | 59 | CCM891XC.....    | 61 | CCR04028.....   | 74 | CCR30029.....    | 69 |
| CCA3400XJSL..... | 50 | CCA9100.....     | 49 | CCM3300SL.....    | 62 | CCM891XJ.....    | 61 | CCR04029.....   | 69 | CCR30028.....    | 74 |
| CCA3400XNSL..... | 50 | CCA9100SL.....   | 49 | CCM3302SL.....    | 61 | CCM891XN.....    | 61 | CCR04037.....   | 70 | CCR3400SL.....   | 78 |
| CCA3400XRSL..... | 50 | CCA9200.....     | 49 | CCM3303SL.....    | 60 | CCM891XR.....    | 61 | CCR04037A.....  | 70 | CCR3400XCSL..... | 78 |
| CCA3401SL.....   | 48 | CCA9300.....     | 49 | CCM3305SL.....    | 58 | CCM892.....      | 60 | CCR040R.....    | 79 | CCR3400XHSL..... | 73 |
| CCA3402SL.....   | 48 | HW30T.....       | 48 | CCM3309SL.....    | 57 | CCM893.....      | 58 | CCR100.....     | 79 | CCR3400XJSL..... | 78 |
| CCA3450SL.....   | 51 | HWRT.....        | 48 | CCM3310BSL.....   | 59 | CCM894.....      | 57 | CCR10022.....   | 76 | CCR3400XNSL..... | 78 |
| CCA3450XCSL..... | 50 | VG30T.....       | 48 | CCM3400SL.....    | 62 | CCM895B.....     | 58 | CCR100A.....    | 79 | CCR3400XRSL..... | 78 |
| CCA3450XJSL..... | 50 | VGRT.....        | 48 | CCM3400XCSSL..... | 61 | CCM898.....      | 61 | CCR100R.....    | 79 | CCR3405SL.....   | 71 |
| CCA3450XNSL..... | 50 |                  |    | CCM3400XHSL.....  | 59 | CCM89812SL.....  | 56 | CCR1414.....    | 72 | CCR3405SL.....   | 71 |
| CCA3450XRSL..... | 50 |                  |    | CCM3400XJSL.....  | 61 | CCM89818.....    | 56 | CCR1415.....    | 72 | CCR3406SL.....   | 75 |
| CCA3500SL.....   | 51 |                  |    | CCM3400XNSL.....  | 57 | CCM89922.....    | 56 | CCR1417.....    | 72 | CCR3407SL.....   | 75 |
| CCA3500XCSL..... | 50 |                  |    | CCM3400XRSL.....  | 61 | CCM89925SL.....  | 56 | CCR1423.....    | 72 | CCR3408SL.....   | 74 |
| CCA3500XJSL..... | 50 | 19020T.....      | 62 | CCM3403SL.....    | 60 | CCM9811.....     | 56 | CCR1423SL.....  | 72 | CCR3409SL.....   | 69 |
| CCA3500XNSL..... | 50 | 19200T.....      | 62 | CCM3405SL.....    | 58 | CCM9812.....     | 56 | CCR1511.....    | 73 | CCR3410BSL.....  | 72 |
| CCA3500XRSL..... | 50 | 19220T.....      | 62 | CCM3409SL.....    | 57 | CCM9812SL.....   | 56 | CCR1511A.....   | 73 | CCR3412SL.....   | 77 |
| CCA3501SL.....   | 48 | AB30T.....       | 59 | CCM3412SL.....    | 61 | CCM9816.....     | 56 | CCR1514.....    | 73 | CCR8000XCSL..... | 78 |
| CCA3502SL.....   | 48 | ABRT.....        | 59 | CCM3500SL.....    | 62 | CCM9923.....     | 56 | CCR1514A.....   | 73 | CCR8000XJSL..... | 73 |
| CCA3560SL.....   | 51 | ARHRT.....       | 57 | CCM3502SL.....    | 61 | CCM9925.....     | 56 | CCR1515.....    | 73 | CCR8000XNSL..... | 70 |
| CCA3560XCSL..... | 50 | AS30T.....       | 58 | CCM3503SL.....    | 60 | CCM9925SL.....   | 56 | CCR1516.....    | 73 | CCR8001SL.....   | 71 |
| CCA3560XJSL..... | 50 | ASET.....        | 58 | CCM3505SL.....    | 58 | CCM9926.....     | 56 | CCR1518.....    | 73 | CCR8005.....     | 79 |
| CCA3560XNSL..... | 50 | ASHRT.....       | 58 | CCM3509SL.....    | 57 | DLHRT.....       | 62 | CCR1518.....    | 73 | CCR8005A.....    | 79 |
|                  |    | ASRT.....        | 58 |                   |    | HW30T.....       | 56 | CCR1528.....    | 73 | CCR8006SL.....   | 75 |
|                  |    | BEBHRT.....      | 59 |                   |    |                  |    |                 |    | CCR8007SL.....   | 75 |

**Mahogany  
Collection.**

CCR8008SL ..... 74  
 CCR8009SL ..... 69  
 CCR800XCSL ..... 78  
 CCR800XJSL ..... 78  
 CCR800XNSL ..... 78  
 CCR800XRSL ..... 78  
 CCR8010BSL ..... 72  
 CCR802530XC ..... 78  
 CCR802530XJ ..... 78  
 CCR802530XN ..... 78  
 CCR802530XR ..... 78  
 CCR8040 ..... 79  
 CCR804020 ..... 78  
 CCR804020XC ..... 77  
 CCR804020XJ ..... 77  
 CCR804020XN ..... 77  
 CCR804020XR ..... 77  
 CCR804022 ..... 76  
 CCR804023 ..... 75  
 CCR804025 ..... 71  
 CCR804026 ..... 75  
 CCR804027 ..... 70  
 CCR804028 ..... 74  
 CCR804029 ..... 69  
 CCR804030 ..... 78  
 CCR804030A ..... 78  
 CCR804030AXC ..... 78  
 CCR804030XJ ..... 78  
 CCR804030AXN ..... 78  
 CCR804030AXR ..... 78  
 CCR804030XC ..... 77  
 CCR804030XJ ..... 77  
 CCR804030XN ..... 77  
 CCR804030XR ..... 77  
 CCR804032A ..... 77  
 CCR804035 ..... 71  
 CCR804035A ..... 71  
 CCR804037 ..... 70  
 CCR804037A ..... 70  
 CCR8040R ..... 79  
 CCR80424B ..... 72  
 CCR8100 ..... 79  
 CCR8100A ..... 79  
 CCR8100R ..... 79  
 CCR8102SL ..... 77  
 CCR81414 ..... 72  
 CCR81415 ..... 72  
 CCR81417 ..... 72  
 CCR81423SL ..... 72  
 CCR81511 ..... 73  
 CCR81511A ..... 73  
 CCR81512 ..... 73  
 CCR81512A ..... 73  
 CCR81514 ..... 73  
 CCR81514A ..... 73  
 CCR81515 ..... 73  
 CCR81516 ..... 73  
 CCR81518 ..... 73  
 CCR81838 ..... 76  
 CCR81839 ..... 76  
 CCR81841 ..... 76  
 CCR81845 ..... 76  
 CCR81845A ..... 76  
 CCR81846 ..... 76  
 CCR81846A ..... 76  
 CCR81847 ..... 76  
 CCR81847A ..... 76  
 CCR81851SL ..... 76  
 CCR8200 ..... 79  
 CCR820020 ..... 78  
 CCR820020XC ..... 77  
 CCR820020XJ ..... 77

CCR820020XN ..... 77  
 CCR820020XR ..... 77  
 CCR820022 ..... 76  
 CCR820023 ..... 75  
 CCR820024B ..... 71  
 CCR820025 ..... 72  
 CCR820026 ..... 75  
 CCR820027 ..... 70  
 CCR820028 ..... 74  
 CCR820029 ..... 68  
 CCR820030 ..... 79  
 CCR820030A ..... 78  
 CCR820030AXC ..... 78  
 CCR820030AXJ ..... 78  
 CCR820030AXN ..... 78  
 CCR820030AXR ..... 78  
 CCR820030XC ..... 78  
 CCR820030XJ ..... 78  
 CCR820030XN ..... 78  
 CCR820030XR ..... 78  
 CCR820032 ..... 77  
 CCR820032A ..... 77  
 CCR820035 ..... 71  
 CCR820035A ..... 71  
 CCR820037 ..... 70  
 CCR820037A ..... 70  
 CCR8200A ..... 79  
 CCR8205 ..... 79  
 CCR820520 ..... 78  
 CCR820520XC ..... 77  
 CCR820520XJ ..... 77  
 CCR820520XN ..... 77  
 CCR820520XR ..... 77  
 CCR820522 ..... 76  
 CCR820523 ..... 75  
 CCR820524B ..... 72  
 CCR820525 ..... 71  
 CCR820526 ..... 75  
 CCR820527 ..... 70  
 CCR820528 ..... 74  
 CCR820529 ..... 69  
 CCR820530 ..... 78  
 CCR820530A ..... 78  
 CCR820530AXC ..... 78  
 CCR820530AXJ ..... 78  
 CCR820530AXN ..... 78  
 CCR820530AXR ..... 78  
 CCR8205320 ..... 76  
 CCR820532A ..... 77  
 CCR820535 ..... 71  
 CCR820537 ..... 70  
 CCR820537A ..... 70  
 CCR8205A ..... 79  
 CCR8220 ..... 79  
 CCR8220R ..... 79  
 CCR8222 ..... 79  
 CCR822214 ..... 72  
 CCR822215 ..... 73  
 CCR822218 ..... 69  
 CCR822219 ..... 68  
 CCR822220 ..... 78  
 CCR822220XR ..... 77  
 CCR822222 ..... 76  
 CCR822223 ..... 75  
 CCR822224B ..... 72  
 CCR822225 ..... 71  
 CCR822226 ..... 75  
 CCR822227 ..... 70  
 CCR822228 ..... 74  
 CCR822229 ..... 69  
 CCR822238 ..... 76  
 CCR8225 ..... 79

CCR8225R ..... 79  
 CCR89819 ..... 68  
 CCR89821 ..... 68  
 CCR89822 ..... 68  
 CCR89918 ..... 69  
 CCR89919 ..... 69  
 CCR89921 ..... 69  
 CCR89925SL ..... 69  
 CCR9812 ..... 68  
 CCR9812SL ..... 68  
 CCR9819 ..... 68  
 CCR9821 ..... 68  
 CCR9822 ..... 68  
 CCR9812SL ..... 68  
 CCR9918 ..... 69  
 CCR9919 ..... 69  
 CCR9921 ..... 69  
 CCR9925 ..... 69  
 CCR9925SL ..... 69  
 DLHRT ..... 78  
 HW30T ..... 69  
 HWRT ..... 69  
 LC30T ..... 77  
 LCET ..... 77  
 LCHRT ..... 77  
 LCRT ..... 77  
 LF30T ..... 75  
 LFET ..... 75  
 LFHRT ..... 75  
 LFRT ..... 75  
 PRHRT ..... 74  
 VG30T ..... 68  
 VGRT ..... 68  
 ZHHRT ..... 76  
 ZHRT ..... 76

**Oak Collection.**

19020T ..... 90  
 19020T ..... 90  
 19200T ..... 90  
 19200T ..... 90  
 19220T ..... 90  
 19220T ..... 90  
 AB30T ..... 86  
 ABRT ..... 86  
 ARHRT ..... 85  
 BEBHRT ..... 85  
 BEET-B ..... 85  
 BERT-B ..... 85  
 CBHRT ..... 88  
 CC040T ..... 87  
 CC060T ..... 85  
 CC090T ..... 88  
 CC10 ..... 90  
 CC100 ..... 90  
 CC10022 ..... 88  
 CC100XC ..... 89  
 CC100XJ ..... 89  
 CC100XN ..... 89  
 CC100XR ..... 89  
 CC1010SL ..... 90  
 CC1016SL ..... 88  
 CC1017SL ..... 87  
 CC1019SL ..... 85  
 CC102 ..... 90  
 CC102XC ..... 89  
 CC102XJ ..... 89  
 CC102XN ..... 89  
 CC102XR ..... 89  
 CC106 ..... 87  
 CC107 ..... 87  
 CC109 ..... 84  
 CC11 ..... 91  
 CC110B ..... 85

CC830XJ ..... 89  
 CC830XN ..... 89  
 CC830XR ..... 89  
 CC831 ..... 91  
 CC832 ..... 90  
 CC832XC ..... 89  
 CC832XJ ..... 89  
 CC832XN ..... 89  
 CC832XR ..... 89  
 CC833 ..... 88  
 CC836 ..... 87  
 CC837 ..... 87  
 CC839 ..... 84  
 CC860 ..... 91  
 CC890 ..... 90  
 CC890XC ..... 89  
 CC890XJ ..... 89  
 CC890XN ..... 89  
 CC890XR ..... 89  
 CC892 ..... 90  
 CC892XC ..... 89  
 CC892XJ ..... 89  
 CC892XN ..... 89  
 CC896 ..... 87  
 CC897 ..... 87  
 CC898 ..... 88  
 CC89812SL ..... 84  
 CC89815 ..... 84  
 CC89818 ..... 84  
 CC89819 ..... 84  
 CC89922 ..... 84  
 CC89924 ..... 84  
 CC89925SL ..... 84  
 CC90 ..... 90  
 CC900B ..... 85  
 CC900T ..... 88  
 CC901B ..... 85  
 CC90XC ..... 89  
 CC90XJ ..... 89  
 CC90XN ..... 89  
 CC90XR ..... 89  
 CC91 ..... 91  
 CC92 ..... 90  
 CC920T ..... 88  
 CC922 ..... 88  
 CC925 ..... 84  
 CC92XC ..... 89  
 CC92XJ ..... 89  
 CC92XN ..... 89  
 CC92XR ..... 89  
 CC96 ..... 87  
 CC97 ..... 87  
 CC9811 ..... 84  
 CC9812 ..... 84  
 CC9812SL ..... 84  
 CC9818 ..... 84  
 CC99 ..... 84  
 CC9922 ..... 84  
 CC9925SL ..... 84  
 CC9926 ..... 84  
 DLHRT ..... 90  
 HW30T ..... 84  
 HWRT ..... 84  
 LC30T ..... 88  
 LCET ..... 88  
 LCHRT ..... 88  
 LCRT ..... 88  
 PRHRT ..... 87  
 VG30T ..... 84  
 VGRT ..... 84  
 CC1020BSL ..... 85

**Canvas Collection.**  
 19020T ..... 108  
 19200T ..... 108  
 19210T ..... 108  
 19220T ..... 108  
 AB30T ..... 101  
 ABRT ..... 101  
 ARHRT ..... 98  
 AS30T ..... 100  
 ASET ..... 100  
 ASHRT ..... 100  
 ASRT ..... 100  
 BEBHRT ..... 100  
 BEET-B ..... 100  
 BERT-B ..... 100  
 CBHRT ..... 104  
 CC040T ..... 102  
 CC060T ..... 98  
 CC090T ..... 104  
 CC400T ..... 102  
 CC600T ..... 98  
 CC620T ..... 98  
 CC900T ..... 104  
 CC920T ..... 104  
 CC950 ..... 108  
 CCV05012 ..... 107  
 CCV05012XC ..... 105  
 CCV05012XJ ..... 105  
 CCV05012XN ..... 105  
 CCV05012XR ..... 105  
 CCV05020 ..... 107  
 CCV05020XC ..... 106  
 CCV05020XJ ..... 106  
 CCV05020XN ..... 106  
 CCV05020XR ..... 106  
 CCV05022 ..... 105  
 CCV05023 ..... 103  
 CCV05024B ..... 100  
 CCV05025 ..... 99  
 CCV05026 ..... 103  
 CCV05027 ..... 99  
 CCV05028 ..... 102  
 CCV05029 ..... 98  
 CCV060 ..... 108  
 CCV06020 ..... 108  
 CCV06022 ..... 105  
 CCV06023 ..... 103  
 CCV06024B ..... 100  
 CCV06025 ..... 100  
 CCV06026 ..... 104  
 CCV06028 ..... 102  
 CCV06029 ..... 98  
 CCV0609 ..... 107  
 CCV10015 ..... 107  
 CCV10015XC ..... 105  
 CCV10015XJ ..... 105  
 CCV10015XN ..... 105  
 CCV10015XR ..... 105  
 CCV10020 ..... 107  
 CCV10020XC ..... 106  
 CCV10020XJ ..... 106  
 CCV10020XN ..... 106  
 CCV10020XR ..... 106  
 CCV10022 ..... 105  
 CCV10023 ..... 103  
 CCV10024B ..... 100  
 CCV10025 ..... 99  
 CCV10026 ..... 103  
 CCV10027 ..... 99  
 CCV10028 ..... 102  
 CCV10029 ..... 98  
 CCV100SL ..... 108

|                 |     |                 |     |                  |     |                   |     |                  |     |                 |     |
|-----------------|-----|-----------------|-----|------------------|-----|-------------------|-----|------------------|-----|-----------------|-----|
| CCV100XCSL..... | 106 | CCV20526.....   | 103 | CCV803012XC..... | 105 | CCV806022.....    | 105 | CCV820530XR..... | 106 | CCV930XC.....   | 106 |
| CCV100XHSL..... | 102 | CCV20527.....   | 99  | CCV803012XJ..... | 105 | CCV806023.....    | 103 | CCV820532.....   | 105 | CCV930XJ.....   | 106 |
| CCV100XJSL..... | 106 | CCV20528.....   | 102 | CCV803012XN..... | 105 | CCV806024B.....   | 100 | CCV820532A.....  | 105 | CCV930XN.....   | 106 |
| CCV100XNSL..... | 99  | CCV20529.....   | 98  | CCV803012XR..... | 105 | CCV806025.....    | 100 | CCV820535A.....  | 100 | CCV930XR.....   | 106 |
| CCV100XNSL..... | 106 | CCV20537.....   | 99  | CCV803020.....   | 108 | CCV806026.....    | 104 | CCV820537.....   | 99  | CCV931.....     | 98  |
| CCV100XRSL..... | 106 | CCV20537A.....  | 99  | CCV803020XC..... | 106 | CCV806027.....    | 99  | CCV820537A.....  | 99  | CCV932.....     | 97  |
| CCV103SL.....   | 103 | CCV205A.....    | 108 | CCV803020XJ..... | 106 | CCV806028.....    | 102 | CCV8205A.....    | 108 | CCV940.....     | 107 |
| CCV104BSL.....  | 100 | CCV220.....     | 108 | CCV803020XN..... | 106 | CCV806029.....    | 98  | CCV8220.....     | 108 | CCV940XC.....   | 106 |
| CCV105SL.....   | 100 | CCV22020.....   | 107 | CCV803020XR..... | 106 | CCV8100SL.....    | 108 | CCV822012.....   | 107 | CCV940XJ.....   | 106 |
| CCV106SL.....   | 104 | CCV22020XC..... | 106 | CCV803022.....   | 105 | CCV8100XCSL.....  | 106 | CCV822012XC..... | 105 | CCV940XN.....   | 106 |
| CCV108SL.....   | 102 | CCV22020XJ..... | 106 | CCV803023.....   | 103 | CCV8100XHSL.....  | 102 | CCV822012XJ..... | 105 | CCV940XR.....   | 106 |
| CCV109SL.....   | 98  | CCV22020XN..... | 106 | CCV803024B.....  | 100 | CCV8100XJSL.....  | 106 | CCV822012XN..... | 105 | CCV950SL.....   | 107 |
| CCV1414.....    | 101 | CCV22020XR..... | 106 | CCV803025.....   | 100 | CCV8100XNSL.....  | 99  | CCV822012XR..... | 105 | CCV950XCSL..... | 106 |
| CCV1415.....    | 101 | CCV22022.....   | 105 | CCV803026.....   | 104 | CCV8100XNSL.....  | 106 | CCV822020.....   | 107 | CCV950XJSL..... | 106 |
| CCV1416.....    | 101 | CCV22023.....   | 103 | CCV803027.....   | 99  | CCV8100XRSL.....  | 106 | CCV822020XC..... | 106 | CCV950XNSL..... | 106 |
| CCV14188.....   | 101 | CCV22024B.....  | 100 | CCV803028.....   | 102 | CCV8102SL.....    | 105 | CCV822020XJ..... | 106 | CCV950XRSL..... | 106 |
| CCV1423.....    | 101 | CCV22025.....   | 99  | CCV803029.....   | 98  | CCV8103SL.....    | 103 | CCV822020XN..... | 106 | CCV960.....     | 107 |
| CCV1423SL.....  | 101 | CCV22026.....   | 103 | CCV805015.....   | 107 | CCV8104BSL.....   | 100 | CCV822020XR..... | 106 | CCV960XC.....   | 106 |
| CCV1424.....    | 101 | CCV22027.....   | 99  | CCV805015XC..... | 105 | CCV8105SL.....    | 100 | CCV822022.....   | 105 | CCV960XJ.....   | 106 |
| CCV1512.....    | 101 | CCV22028.....   | 102 | CCV805015XJ..... | 105 | CCV8106SL.....    | 104 | CCV822023.....   | 103 | CCV960XN.....   | 106 |
| CCV1512A.....   | 102 | CCV22029.....   | 98  | CCV805015XN..... | 105 | CCV8108SL.....    | 102 | CCV822024B.....  | 100 | CCV960XR.....   | 106 |
| CCV1513.....    | 102 | CCV3412SL.....  | 105 | CCV805015XR..... | 105 | CCV8109SL.....    | 98  | CCV822025.....   | 99  | CCV9811.....    | 97  |
| CCV1513A.....   | 102 | CCV400.....     | 108 | CCV805020.....   | 107 | CCV8111SL.....    | 98  | CCV822026.....   | 103 | CCV9812.....    | 97  |
| CCV1515.....    | 101 | CCV4100.....    | 101 | CCV805020XC..... | 106 | CCV8112SL.....    | 97  | CCV822027.....   | 99  | CCV9818.....    | 97  |
| CCV1516.....    | 101 | CCV4100SL.....  | 101 | CCV805020XJ..... | 106 | CCV81414.....     | 101 | CCV822028.....   | 102 | CCV9820.....    | 97  |
| CCV1517.....    | 101 | CCV4200.....    | 101 | CCV805020XN..... | 106 | CCV81415.....     | 101 | CCV822029.....   | 98  | CCV9821.....    | 97  |
| CCV1519.....    | 101 | CCV4300.....    | 101 | CCV805020XR..... | 106 | CCV81417.....     | 101 | CCV820535.....   | 99  | CCV9822.....    | 97  |
| CCV1528.....    | 101 | CCV455.....     | 108 | CCV805022.....   | 105 | CCV81418.....     | 101 | CCV831.....      | 108 | CCV9918.....    | 97  |
| CCV1838.....    | 104 | CCV45520.....   | 107 | CCV805023.....   | 103 | CCV81420.....     | 101 | CCV860.....      | 108 | CCV9919.....    | 97  |
| CCV1839.....    | 104 | CCV45520XC..... | 106 | CCV805024B.....  | 100 | CCV81423SL.....   | 101 | CCV8950SL.....   | 107 | CCV9920.....    | 97  |
| CCV1840.....    | 104 | CCV45520XJ..... | 106 | CCV805025.....   | 99  | CCV81512.....     | 101 | CCV8950XCSL..... | 106 | CCV9922.....    | 97  |
| CCV1843.....    | 104 | CCV45520XN..... | 106 | CCV805026.....   | 103 | CCV81512A.....    | 102 | CCV8950XJSL..... | 106 | CCV9925.....    | 97  |
| CCV1851.....    | 104 | CCV45520XR..... | 106 | CCV805027.....   | 99  | CCV81515.....     | 101 | CCV8950XNSL..... | 106 | CCV9926.....    | 97  |
| CCV1851SL.....  | 104 | CCV45522.....   | 105 | CCV805028.....   | 102 | CCV81516.....     | 101 | CCV8950XRSL..... | 106 | DLHRT.....      | 108 |
| CCV200.....     | 108 | CCV45523.....   | 103 | CCV805029.....   | 98  | CCV81518.....     | 102 | CCV89815.....    | 97  | HW30T.....      | 98  |
| CCV205.....     | 108 | CCV45524B.....  | 100 | CCV806012.....   | 107 | CCV81519.....     | 101 | CCV89818.....    | 97  | HWRT.....       | 98  |
| CCV20520.....   | 107 | CCV45525.....   | 99  | CCV806012XC..... | 105 | CCV81520.....     | 102 | CCV89819.....    | 97  | LC30T.....      | 105 |
| CCV20520XC..... | 106 | CCV45526.....   | 103 | CCV806012XJ..... | 105 | CCV81838.....     | 104 | CCV89821.....    | 97  | LCET.....       | 105 |
| CCV20520XJ..... | 106 | CCV45527.....   | 99  | CCV806012XN..... | 105 | CCV81839.....     | 104 | CCV89822.....    | 97  | LCHRT.....      | 105 |
| CCV20520XN..... | 106 | CCV45528.....   | 102 | CCV806012XR..... | 105 | CCV81840.....     | 104 | CCV89918.....    | 97  | LCRT.....       | 105 |
| CCV20520XR..... | 106 | CCV45529.....   | 98  | CCV806020.....   | 108 | CCV81841.....     | 104 | CCV89919.....    | 97  | LF30T.....      | 103 |
| CCV20522.....   | 105 | CCV45537.....   | 99  | CCV806020XC..... | 106 | CCV81843.....     | 104 | CCV89921.....    | 97  | LFET.....       | 103 |
| CCV20523.....   | 103 | CCV45537A.....  | 99  | CCV806020XJ..... | 106 | CCV81846.....     | 104 | CCV89922.....    | 97  | LFHRT.....      | 103 |
| CCV20524B.....  | 100 | CCV455A.....    | 108 | CCV806020XN..... | 106 | CCV81846A.....    | 104 | CCV89924.....    | 98  | LFRT.....       | 103 |
| CCV20525.....   | 99  | CCV803012.....  | 107 | CCV806020XR..... | 106 | CCV81851SL.....   | 104 | CCV9010SL.....   | 108 | PRHRT.....      | 102 |
|                 |     |                 |     |                  |     | CCV8205.....      | 108 | CCV9011SL.....   | 98  | VG30T.....      | 97  |
|                 |     |                 |     |                  |     | CCV820512.....    | 107 | CCV9012SL.....   | 97  | VGRT.....       | 97  |
|                 |     |                 |     |                  |     | CCV820512XC.....  | 105 | CCV9020SL.....   | 107 | ZHHRT.....      | 104 |
|                 |     |                 |     |                  |     | CCV820512XJ.....  | 105 | CCV910.....      | 108 | ZHRT.....       | 104 |
|                 |     |                 |     |                  |     | CCV820512XN.....  | 105 | CCV910XC.....    | 106 |                 |     |
|                 |     |                 |     |                  |     | CCV820512XR.....  | 105 | CCV910XCSL.....  | 106 |                 |     |
|                 |     |                 |     |                  |     | CCV820520.....    | 107 | CCV910XJ.....    | 106 |                 |     |
|                 |     |                 |     |                  |     | CCV820520XC.....  | 106 | CCV910XJSL.....  | 106 |                 |     |
|                 |     |                 |     |                  |     | CCV820520XJ.....  | 106 | CCV910XN.....    | 106 |                 |     |
|                 |     |                 |     |                  |     | CCV820520XN.....  | 106 | CCV910XNSL.....  | 106 |                 |     |
|                 |     |                 |     |                  |     | CCV820520XR.....  | 106 | CCV910XR.....    | 106 |                 |     |
|                 |     |                 |     |                  |     | CCV820522.....    | 105 | CCV910XRSL.....  | 106 |                 |     |
|                 |     |                 |     |                  |     | CCV820523.....    | 103 | CCV911.....      | 98  |                 |     |
|                 |     |                 |     |                  |     | CCV820524B.....   | 100 | CCV911SL.....    | 98  |                 |     |
|                 |     |                 |     |                  |     | CCV820525.....    | 99  | CCV912.....      | 97  |                 |     |
|                 |     |                 |     |                  |     | CCV820526.....    | 103 | CCV912SL.....    | 97  |                 |     |
|                 |     |                 |     |                  |     | CCV820527.....    | 99  | CCV920.....      | 107 |                 |     |
|                 |     |                 |     |                  |     | CCV820528.....    | 102 | CCV920XC.....    | 106 |                 |     |
|                 |     |                 |     |                  |     | CCV820529.....    | 98  | CCV920XCSL.....  | 106 |                 |     |
|                 |     |                 |     |                  |     | CCV820530.....    | 108 | CCV920XJ.....    | 106 |                 |     |
|                 |     |                 |     |                  |     | CCV820530A.....   | 108 | CCV920XJSL.....  | 106 |                 |     |
|                 |     |                 |     |                  |     | CCV820530AXC..... | 106 | CCV920XN.....    | 106 |                 |     |
|                 |     |                 |     |                  |     | CCV820530AXJ..... | 106 | CCV920XNSL.....  | 106 |                 |     |
|                 |     |                 |     |                  |     | CCV820530AXN..... | 106 | CCV920XR.....    | 106 |                 |     |
|                 |     |                 |     |                  |     | CCV820530AXR..... | 106 | CCV920XRSL.....  | 106 |                 |     |
|                 |     |                 |     |                  |     | CCV820530XC.....  | 106 | CCV921.....      | 98  |                 |     |
|                 |     |                 |     |                  |     | CCV820530XJ.....  | 106 | CCV922.....      | 97  |                 |     |
|                 |     |                 |     |                  |     | CCV820530XN.....  | 106 | CCV930.....      | 107 |                 |     |



Bottom: Classic-Craft Canvas Collection, Ashurst Glass, Door – CCV20525, Sidelite – CCV105SL



# Fiber-Classic® & Smooth-Star®

## Fiber-Classic® Mahogany Collection.

|                   |     |                 |     |                  |     |                |     |                  |     |                   |     |
|-------------------|-----|-----------------|-----|------------------|-----|----------------|-----|------------------|-----|-------------------|-----|
| FCM10.....        | 196 | FCM1283XR.....  | 170 | FCM18XN.....     | 167 | FCM6022XC..... | 167 | FCM6107.....     | 137 | FCM755.....       | 200 |
| FCM100.....       | 131 | FCM1284.....    | 183 | FCM18XR.....     | 167 | FCM6022XE..... | 167 | FCM6108.....     | 137 | FCM758.....       | 140 |
| FCM1000.....      | 200 | FCM1284XC.....  | 167 | FCM198.....      | 185 | FCM6022XJ..... | 167 | FCM6124SL.....   | 185 | FCM760.....       | 125 |
| FCM1006.....      | 137 | FCM1284XE.....  | 167 | FCM205.....      | 200 | FCM6022XN..... | 167 | FCM6124XCSL..... | 167 | FCM761.....       | 140 |
| FCM100-A.....     | 131 | FCM1284XJ.....  | 167 | FCM2101SL.....   | 184 | FCM6022XR..... | 167 | FCM6124XESL..... | 167 | FCM761SL.....     | 140 |
| FCM101.....       | 131 | FCM1284XN.....  | 167 | FCM2106.....     | 183 | FCM6023.....   | 161 | FCM6124XJSL..... | 167 | FCM763.....       | 161 |
| FCM101-A.....     | 131 | FCM1284XR.....  | 167 | FCM2107.....     | 183 | FCM6025.....   | 131 | FCM6124XNSL..... | 167 | FCM764.....       | 140 |
| FCM101SL.....     | 131 | FCM1285.....    | 183 | FCM2108.....     | 183 | FCM6025-A..... | 131 | FCM6124XRSL..... | 167 | FCM764SL.....     | 140 |
| FCM101SL-A.....   | 131 | FCM1285XC.....  | 167 | FCM220.....      | 200 | FCM6026.....   | 152 | FCM6125SL.....   | 185 | FCM765.....       | 125 |
| FCM1027.....      | 140 | FCM1285XE.....  | 167 | FCM241.....      | 131 | FCM6027.....   | 128 | FCM6125XCSL..... | 167 | FCM765SL.....     | 125 |
| FCM1029.....      | 144 | FCM1285XJ.....  | 167 | FCM241-A.....    | 131 | FCM6029.....   | 142 | FCM6125XESL..... | 167 | FCM784.....       | 161 |
| FCM104.....       | 146 | FCM1285XN.....  | 167 | FCM3000-2C.....  | 185 | FCM6030.....   | 146 | FCM6125XJSL..... | 167 | FCM785.....       | 140 |
| FCM104XC.....     | 171 | FCM1285XR.....  | 167 | FCM3000-3C.....  | 185 | FCM6031.....   | 134 | FCM6125XNSL..... | 167 | FCM787.....       | 161 |
| FCM104XE.....     | 171 | FCM1286.....    | 174 | FCM3000-4C.....  | 185 | FCM6032.....   | 125 | FCM6125XRSL..... | 167 | FCM788.....       | 140 |
| FCM104XJ.....     | 171 | FCM1286SL.....  | 174 | FCM3000-6C.....  | 185 | FCM6035.....   | 174 | FCM6126SL.....   | 185 | FCM789.....       | 155 |
| FCM104XN.....     | 171 | FCM1289.....    | 185 | FCM3000F-2C..... | 185 | FCM6036.....   | 155 | FCM6126XCSL..... | 167 | FCM80.....        | 196 |
| FCM104XR.....     | 171 | FCM1289SL.....  | 186 | FCM3000F-3C..... | 185 | FCM604.....    | 131 | FCM6126XESL..... | 167 | FCM800.....       | 140 |
| FCM105.....       | 146 | FCM131.....     | 131 | FCM3000F-4C..... | 185 | FCM6041.....   | 196 | FCM6126XJSL..... | 167 | FCM802.....       | 129 |
| FCM105SL.....     | 147 | FCM13101SL..... | 161 | FCM3000F-6C..... | 185 | FCM6041XC..... | 171 | FCM6126XNSL..... | 167 | FCM807SL.....     | 140 |
| FCM106.....       | 147 | FCM131-A.....   | 131 | FCM31.....       | 200 | FCM6041XE..... | 171 | FCM6126XRSL..... | 167 | FCM808SL.....     | 125 |
| FCM108.....       | 125 | FCM131SL.....   | 131 | FCM310.....      | 125 | FCM6041XJ..... | 171 | FCM61XC.....     | 171 | FCM809SL.....     | 152 |
| FCM1089SL.....    | 184 | FCM131SL-A..... | 131 | FCM32.....       | 196 | FCM6041XN..... | 171 | FCM61XE.....     | 171 | FCM81000.....     | 200 |
| FCM109.....       | 125 | FCM132.....     | 196 | FCM32SL.....     | 197 | FCM6041XR..... | 171 | FCM61XJ.....     | 171 | FCM8101SL.....    | 184 |
| FCM109SL.....     | 125 | FCM134.....     | 200 | FCM32XC.....     | 170 | FCM6042.....   | 184 | FCM61XN.....     | 171 | FCM8101XCSL.....  | 167 |
| FCM10XC.....      | 170 | FCM138.....     | 183 | FCM32XCSL.....   | 171 | FCM6042XC..... | 167 | FCM61XR.....     | 171 | FCM8101XESL.....  | 167 |
| FCM10XE.....      | 170 | FCM138XC.....   | 167 | FCM32XE.....     | 170 | FCM6042XE..... | 167 | FCM62.....       | 196 | FCM8101XJSL.....  | 167 |
| FCM10XJ.....      | 170 | FCM138XE.....   | 167 | FCM32XESL.....   | 171 | FCM6042XJ..... | 167 | FCM626.....      | 155 | FCM8101XNSL.....  | 167 |
| FCM10XN.....      | 170 | FCM138XJ.....   | 167 | FCM32XJ.....     | 170 | FCM6042XN..... | 167 | FCM62SL.....     | 197 | FCM8101XRSL.....  | 167 |
| FCM10XR.....      | 170 | FCM138XN.....   | 167 | FCM32XJSL.....   | 171 | FCM6042XR..... | 167 | FCM62XC.....     | 170 | FCM8103SL.....    | 145 |
| FCM11.....        | 161 | FCM138XR.....   | 167 | FCM32XN.....     | 170 | FCM6043.....   | 161 | FCM62XCSL.....   | 171 | FCM8104SL.....    | 140 |
| FCM110.....       | 125 | FCM1400SL.....  | 186 | FCM32XNSL.....   | 171 | FCM6045.....   | 131 | FCM62XE.....     | 170 | FCM8105SL.....    | 129 |
| FCM113.....       | 134 | FCM1402.....    | 185 | FCM32XR.....     | 170 | FCM6045-A..... | 131 | FCM62XESL.....   | 171 | FCM8107SL.....    | 155 |
| FCM114.....       | 134 | FCM1405.....    | 186 | FCM32XRSL.....   | 171 | FCM6046.....   | 152 | FCM62XJ.....     | 170 | FCM8109SL.....    | 161 |
| FCM114SL.....     | 134 | FCM1405SL.....  | 186 | FCM3487SL.....   | 184 | FCM6047.....   | 128 | FCM62XJSL.....   | 171 | FCM811.....       | 184 |
| FCM115.....       | 134 | FCM1406.....    | 186 | FCM3487XCSL..... | 167 | FCM6049.....   | 142 | FCM62XN.....     | 170 | FCM8110SL.....    | 174 |
| FCM115SL.....     | 134 | FCM1408.....    | 186 | FCM3487XESL..... | 167 | FCM604-A.....  | 131 | FCM62XNSL.....   | 171 | FCM8113.....      | 161 |
| FCM116.....       | 174 | FCM141.....     | 174 | FCM3487XJSL..... | 167 | FCM605.....    | 185 | FCM62XR.....     | 170 | FCM8113SL.....    | 161 |
| FCM118.....       | 134 | FCM142.....     | 144 | FCM3487XNSL..... | 167 | FCM6050.....   | 146 | FCM62XRSL.....   | 171 | FCM8114.....      | 128 |
| FCM1200.....      | 183 | FCM143.....     | 144 | FCM3487XRSL..... | 167 | FCM6051.....   | 134 | FCM63.....       | 183 | FCM8114SL.....    | 129 |
| FCM1200SL.....    | 184 | FCM143SL.....   | 145 | FCM369.....      | 134 | FCM6052.....   | 125 | FCM65.....       | 184 | FCM8115.....      | 174 |
| FCM1201.....      | 183 | FCM144.....     | 144 | FCM38.....       | 128 | FCM6055.....   | 174 | FCM65SL.....     | 184 | FCM8115SL.....    | 174 |
| FCM1201SL.....    | 184 | FCM1442SL.....  | 155 | FCM38SL.....     | 129 | FCM6056.....   | 155 | FCM65XC.....     | 167 | FCM81200.....     | 196 |
| FCM1202.....      | 183 | FCM144SL.....   | 145 | FCM45.....       | 128 | FCM605XC.....  | 167 | FCM65XCSL.....   | 167 | FCM81200SL.....   | 196 |
| FCM1202SL.....    | 184 | FCM146.....     | 144 | FCM45SL.....     | 129 | FCM605XE.....  | 167 | FCM65XE.....     | 167 | FCM81200XC.....   | 170 |
| FCM1203.....      | 183 | FCM147.....     | 146 | FCM506.....      | 149 | FCM605XJ.....  | 167 | FCM65XESL.....   | 167 | FCM81200XCSL..... | 171 |
| FCM1208.....      | 183 | FCM147SL.....   | 147 | FCM508.....      | 149 | FCM605XN.....  | 167 | FCM65XJ.....     | 167 | FCM81200XE.....   | 170 |
| FCM1209.....      | 183 | FCM148.....     | 155 | FCM5425.....     | 174 | FCM605XR.....  | 167 | FCM65XJSL.....   | 167 | FCM81200XESL..... | 171 |
| FCM12101SL.....   | 196 | FCM149.....     | 155 | FCM5425SL.....   | 174 | FCM606.....    | 185 | FCM65XN.....     | 167 | FCM81200XJ.....   | 170 |
| FCM12101XCSL..... | 171 | FCM149SL.....   | 155 | FCM543.....      | 149 | FCM606XC.....  | 167 | FCM65XNSL.....   | 167 | FCM81200XJSL..... | 171 |
| FCM12101XESL..... | 171 | FCM15.....      | 155 | FCM545SL.....    | 149 | FCM606XE.....  | 167 | FCM65XR.....     | 167 | FCM81200XNSL..... | 171 |
| FCM12101XJSL..... | 171 | FCM151.....     | 155 | FCM571.....      | 149 | FCM606XJ.....  | 167 | FCM65XRSL.....   | 167 | FCM81200XR.....   | 170 |
| FCM12101XNSL..... | 171 | FCM156.....     | 155 | FCM572SL.....    | 149 | FCM606XN.....  | 167 | FCM66.....       | 161 | FCM81200XRSL..... | 171 |
| FCM12101XRSL..... | 171 | FCM16.....      | 128 | FCM574.....      | 149 | FCM606XR.....  | 167 | FCM668.....      | 128 | FCM81208P.....    | 183 |
| FCM12102SL.....   | 184 | FCM160.....     | 196 | FCM575.....      | 149 | FCM607.....    | 185 | FCM669.....      | 161 | FCM81208PSL.....  | 184 |
| FCM12102XCSL..... | 167 | FCM163.....     | 147 | FCM577.....      | 149 | FCM6074.....   | 144 | FCM670.....      | 196 | FCM81208SL.....   | 184 |
| FCM12102XESL..... | 167 | FCM164.....     | 125 | FCM581.....      | 149 | FCM6075.....   | 144 | FCM678.....      | 174 | FCM81225.....     | 174 |
| FCM12102XJSL..... | 167 | FCM1645.....    | 158 | FCM583SL.....    | 149 | FCM607XC.....  | 167 | FCM678SL.....    | 174 | FCM8125SL.....    | 174 |
| FCM12102XNSL..... | 167 | FCM1646SL.....  | 158 | FCM60.....       | 200 | FCM607XE.....  | 167 | FCM701SL.....    | 197 | FCM812SL.....     | 137 |
| FCM12102XRSL..... | 167 | FCM1647.....    | 158 | FCM600.....      | 200 | FCM607XJ.....  | 167 | FCM704.....      | 186 | FCM813.....       | 161 |
| FCM1211.....      | 183 | FCM165.....     | 144 | FCM601.....      | 196 | FCM607XN.....  | 167 | FCM707.....      | 142 | FCM81300SL.....   | 161 |
| FCM1212.....      | 183 | FCM1650.....    | 158 | FCM601XC.....    | 171 | FCM607XR.....  | 167 | FCM608.....      | 185 | FCM813SL.....     | 155 |
| FCM124.....       | 129 | FCM1651.....    | 158 | FCM601XE.....    | 171 | FCM608.....    | 185 | FCM608XC.....    | 167 | FCM814.....       | 128 |
| FCM125.....       | 147 | FCM1651SL.....  | 158 | FCM601XJ.....    | 171 | FCM608XC.....  | 167 | FCM608XE.....    | 167 | FCM8145.....      | 186 |
| FCM126.....       | 131 | FCM1652.....    | 158 | FCM601XR.....    | 171 | FCM608XJ.....  | 167 | FCM608XN.....    | 167 | FCM8145SL.....    | 186 |
| FCM126-A.....     | 131 | FCM1654.....    | 158 | FCM602.....      | 142 | FCM608XN.....  | 167 | FCM608XR.....    | 167 | FCM8149.....      | 155 |
| FCM1283.....      | 196 | FCM1656.....    | 158 | FCM6021.....     | 196 | FCM609.....    | 137 | FCM708X.....     | 171 | FCM814SL.....     | 134 |
| FCM1283XC.....    | 170 | FCM1656SL.....  | 158 | FCM6021XC.....   | 170 | FCM6093.....   | 142 | FCM708XE.....    | 171 | FCM815SL.....     | 142 |
| FCM1283XE.....    | 170 | FCM1658.....    | 158 | FCM6021XE.....   | 170 | FCM6094.....   | 146 | FCM712SSL.....   | 184 | FCM816.....       | 125 |
| FCM1283XJ.....    | 170 | FCM18.....      | 183 | FCM6021XJ.....   | 170 | FCM6095.....   | 152 | FCM721.....      | 147 | FCM81645.....     | 158 |
| FCM1283XN.....    | 170 | FCM18101SL..... | 129 | FCM6021XN.....   | 170 | FCM6097.....   | 184 | FCM735.....      | 152 | FCM81646SL.....   | 158 |
|                   |     | FCM18XE.....    | 167 | FCM6021XR.....   | 170 | FCM61.....     | 196 | FCM736.....      | 137 | FCM81651.....     | 158 |
|                   |     | FCM18XJ.....    | 167 | FCM6022.....     | 184 |                |     | FCM752.....      | 184 | FCM81651SL.....   | 158 |

|                   |     |                  |     |                |     |                   |     |                   |     |                   |     |
|-------------------|-----|------------------|-----|----------------|-----|-------------------|-----|-------------------|-----|-------------------|-----|
| FCM81652.....     | 158 | FCM862XESL.....  | 171 | FCM891.....    | 152 | 1283XC.....       | 171 | 81200XJSL.....    | 172 | 81943PXRSLSL..... | 172 |
| FCM81654.....     | 158 | FCM862XJ.....    | 170 | FCM891SL.....  | 152 | 1283XE.....       | 171 | 81200XN.....      | 171 | 81944P.....       | 190 |
| FCM81654SL.....   | 158 | FCM862XJSL.....  | 171 | FCM892SL.....  | 152 | 1283KJ.....       | 171 | 81200XNSL.....    | 172 | 81944PSL.....     | 190 |
| FCM816SL.....     | 131 | FCM862XN.....    | 170 | FCM893SL.....  | 142 | 1283XN.....       | 171 | 81200XR.....      | 171 | 81945P.....       | 187 |
| FCM816SL-A.....   | 131 | FCM862XNSL.....  | 171 | FCM895.....    | 161 | 1283XR.....       | 171 | 81200XRSL.....    | 172 | 81945PXC.....     | 168 |
| FCM817.....       | 134 | FCM862XR.....    | 170 | FCM896.....    | 140 | 1284XC.....       | 168 | 81208.....        | 187 | 81945PXE.....     | 168 |
| FCM817SL.....     | 145 | FCM862XRSL.....  | 171 | FCM896SL.....  | 140 | 1284XE.....       | 168 | 81208PSL.....     | 189 | 81945PXJ.....     | 168 |
| FCM81800SL.....   | 129 | FCM863.....      | 125 | FCM898.....    | 128 | 1284KJ.....       | 168 | 81208SL.....      | 189 | 81945PXN.....     | 168 |
| FCM81828.....     | 183 | FCM863SL.....    | 125 | FCM898SL.....  | 129 | 1284XN.....       | 168 | 81225P.....       | 174 | 81945PXR.....     | 168 |
| FCM81829.....     | 183 | FCM864.....      | 131 | FCM899.....    | 144 | 1284XR.....       | 168 | 81225PSL.....     | 175 | 81946P.....       | 187 |
| FCM818SL.....     | 147 | FCM864-A.....    | 131 | FCM899SL.....  | 145 | 1285XC.....       | 167 | 81225SL.....      | 175 | 81946PSL.....     | 189 |
| FCM81900SL.....   | 185 | FCM864SL-A.....  | 131 | FCM900.....    | 137 | 1285XE.....       | 167 | 81300SL.....      | 162 | 81946PXCSL.....   | 168 |
| FCM81918SL.....   | 125 | FCM865.....      | 134 | FCM901.....    | 137 | 1285KJ.....       | 167 | 81800P.....       | 129 | 81946PXESL.....   | 168 |
| FCM81919SL.....   | 134 | FCM865SL.....    | 134 | FCM901SL.....  | 137 | 1285XN.....       | 167 | 81800PSL.....     | 129 | 81946PXJSL.....   | 168 |
| FCM81921SL.....   | 147 | FCM866SL.....    | 147 | FCM902.....    | 137 | 1285XR.....       | 167 | 81800SL.....      | 130 | 81946PXNSL.....   | 168 |
| FCM81928SL.....   | 152 | FCM8675SL.....   | 184 | FCM902SL.....  | 137 | 1286SL.....       | 175 | 81900PSL.....     | 190 | 81946PXRSLSL..... | 168 |
| FCM81944SL.....   | 186 | FCM8678.....     | 174 | FCM904.....    | 137 | 13101SL.....      | 162 | 81918P.....       | 125 | 81947P.....       | 189 |
| FCM81947SL.....   | 185 | FCM8678SL.....   | 174 | FCM905.....    | 142 | 18101SL.....      | 130 | 81918PSL.....     | 126 | 81947PSL.....     | 190 |
| FCM81949SL.....   | 185 | FCM867SL.....    | 155 | FCM906.....    | 142 | 1964P.....        | 174 | 81918SL.....      | 126 | 81948P.....       | 189 |
| FCM81968SL.....   | 131 | FCM870.....      | 196 | FCM906SL.....  | 142 | 2000SL.....       | 182 | 81919P.....       | 134 | 81949P.....       | 189 |
| FCM81968SL-A..... | 131 | FCM8704.....     | 186 | FCM907.....    | 142 | 2000XC.....       | 166 | 81919PSL.....     | 135 | 81949PSL.....     | 190 |
| FCM81986SL.....   | 142 | FCM8707.....     | 142 | FCM907SL.....  | 142 | 2000XCSL.....     | 166 | 81919SL.....      | 135 | 81950P.....       | 190 |
| FCM82.....        | 183 | FCM8708.....     | 196 | FCM909.....    | 142 | 2000XE.....       | 166 | 81921P.....       | 147 | 81952P.....       | 125 |
| FCM820.....       | 152 | FCM8708XC.....   | 171 | FCM910.....    | 152 | 2000XESL.....     | 166 | 81921PSL.....     | 148 | 81952PSL.....     | 126 |
| FCM821.....       | 146 | FCM8708XE.....   | 171 | FCM911.....    | 152 | 2000XJ.....       | 166 | 81921SL.....      | 148 | 81953P.....       | 129 |
| FCM822.....       | 131 | FCM8708XJ.....   | 171 | FCM911SL.....  | 152 | 2000XJSL.....     | 166 | 81928P.....       | 152 | 81953PSL.....     | 130 |
| FCM822-A.....     | 131 | FCM8708XN.....   | 171 | FCM912.....    | 152 | 2000XN.....       | 166 | 81928PSL.....     | 153 | 81954P.....       | 132 |
| FCM828.....       | 183 | FCM8708XR.....   | 171 | FCM912SL.....  | 152 | 2000XNSL.....     | 166 | 81928SL.....      | 153 | 81954P-A.....     | 132 |
| FCM82XC.....      | 167 | FCM870SL.....    | 197 | FCM914.....    | 152 | 2000XR.....       | 166 | 81929P.....       | 197 | 81954PSL.....     | 132 |
| FCM82XE.....      | 167 | FCM870XC.....    | 170 | FCM915.....    | 152 | 2000XRSL.....     | 166 | 81929PSL.....     | 198 | 81954PSL-A.....   | 132 |
| FCM82XJ.....      | 167 | FCM870XCSSL..... | 171 | FCM916.....    | 152 | 2000XS.....       | 178 | 81929PXC.....     | 171 | 81955P.....       | 134 |
| FCM82XN.....      | 167 | FCM870XE.....    | 170 | FCM916SL.....  | 152 | 2010XC.....       | 163 | 81929PXCSSL.....  | 172 | 81955PSL.....     | 135 |
| FCM82XR.....      | 167 | FCM870XESL.....  | 171 | FCM92SL.....   | 184 | 2010XE.....       | 163 | 81929PXE.....     | 171 | 81956P.....       | 143 |
| FCM83000-2C.....  | 185 | FCM870XJ.....    | 170 | FCM92XCSL..... | 167 | 2010XJ.....       | 163 | 81929PXCSSL.....  | 172 | 81956PSL.....     | 143 |
| FCM83000-3C.....  | 185 | FCM870XJSL.....  | 171 | FCM92XESL..... | 167 | 2010XN.....       | 163 | 81929PXJ.....     | 171 | 81957P.....       | 137 |
| FCM83000-4C.....  | 185 | FCM870XN.....    | 170 | FCM92XJSL..... | 167 | 2010XR.....       | 163 | 81929PXJSL.....   | 172 | 81957PSL.....     | 138 |
| FCM83000-6C.....  | 185 | FCM870XNSL.....  | 171 | FCM92XNSL..... | 167 | 2050SL.....       | 177 | 81929PXN.....     | 171 | 81958P.....       | 145 |
| FCM83000F-2C..... | 185 | FCM870XR.....    | 170 | FCM92XRSL..... | 167 | 2050XC.....       | 163 | 81929PXNSL.....   | 172 | 81958PSL.....     | 145 |
| FCM83000F-3C..... | 185 | FCM870XRSL.....  | 171 | FCM966.....    | 140 | 2050XCSL.....     | 163 | 81929PXR.....     | 171 | 81959P.....       | 147 |
| FCM83000F-4C..... | 185 | FCM871.....      | 125 | FCM968.....    | 140 | 2050XE.....       | 163 | 81929PXRSLSL..... | 172 | 81959PSL.....     | 148 |
| FCM83000F-6C..... | 185 | FCM871SL.....    | 125 |                |     | 2050XESL.....     | 163 | 81931P.....       | 161 | 81960P.....       | 152 |
| FCM8310SL.....    | 184 | FCM872.....      | 131 |                |     | 2050XJ.....       | 163 | 81932P.....       | 140 | 81960PSL.....     | 153 |
| FCM8311SL.....    | 184 | FCM8721.....     | 147 |                |     | 2050XJSL.....     | 163 | 81932PSL.....     | 141 | 81961P.....       | 155 |
| FCM8313SL.....    | 184 | FCM872-A.....    | 131 |                |     | 2050XN.....       | 163 | 81933P.....       | 125 | 81961PSL.....     | 156 |
| FCM8321.....      | 184 | FCM872SL.....    | 131 |                |     | 2050XNSL.....     | 163 | 81933PSL.....     | 126 | 81963P.....       | 161 |
| FCM8321XC.....    | 167 | FCM872SL-A.....  | 131 |                |     | 2050XR.....       | 163 | 81935P.....       | 129 | 81963PSL.....     | 162 |
| FCM8321XE.....    | 167 | FCM873.....      | 134 |                |     | 2050XRSL.....     | 163 | 81935PSL.....     | 130 | 81964P.....       | 174 |
| FCM8321XJ.....    | 167 | FCM8735.....     | 152 |                |     | 8000-12.....      | 177 | 81936P.....       | 132 | 81964PSL.....     | 175 |
| FCM8321XN.....    | 167 | FCM8736.....     | 137 |                |     | 8000-18.....      | 177 | 81936P-A.....     | 132 | 81967P.....       | 140 |
| FCM8321XR.....    | 167 | FCM873SL.....    | 134 |                |     | 8000-9.....       | 178 | 81936PSL.....     | 132 | 81967PSL.....     | 141 |
| FCM8322.....      | 184 | FCM874.....      | 146 |                |     | 8000XC.....       | 166 | 81936PSL-A.....   | 132 | 81968P.....       | 132 |
| FCM8323.....      | 184 | FCM874SL.....    | 147 |                |     | 8000XE.....       | 166 | 81937P.....       | 134 | 81968P-A.....     | 132 |
| FCM8324.....      | 184 | FCM8752.....     | 184 |                |     | 8000XJ.....       | 166 | 81937PSL.....     | 135 | 81968PSL.....     | 132 |
| FCM834SL.....     | 131 | FCM881SL.....    | 197 |                |     | 8000XN.....       | 166 | 81938P.....       | 143 | 81968PSL-A.....   | 132 |
| FCM8545SL.....    | 149 | FCM881XCSSL..... | 171 |                |     | 8000XR.....       | 166 | 81938PSL.....     | 143 | 81968SL.....      | 132 |
| FCM8571.....      | 149 | FCM881XESL.....  | 171 |                |     | 81200P.....       | 197 | 81939PSL.....     | 138 | 81968SL-A.....    | 132 |
| FCM8572SL.....    | 149 | FCM881XJSL.....  | 171 |                |     | 81200PSL.....     | 198 | 81940P.....       | 145 | 81970P.....       | 161 |
| FCM8573SL.....    | 149 | FCM881XNSL.....  | 171 |                |     | 81200PXC.....     | 171 | 81940PSL.....     | 145 | 81971P.....       | 197 |
| FCM8574.....      | 149 | FCM881XRSL.....  | 171 |                |     | 81200PXCSSL.....  | 172 | 81941P.....       | 147 | 81971PXC.....     | 172 |
| FCM8581.....      | 149 | FCM882SL.....    | 125 |                |     | 81200PXE.....     | 171 | 81941PSL.....     | 148 | 81971PXE.....     | 172 |
| FCM8583SL.....    | 149 | FCM883SL.....    | 131 |                |     | 81200PXESL.....   | 172 | 81942P.....       | 152 | 81971PXJ.....     | 172 |
| FCM860.....       | 200 | FCM883SL-A.....  | 131 |                |     | 81200PXJ.....     | 171 | 81942PSL.....     | 153 | 81971PXN.....     | 172 |
| FCM861.....       | 196 | FCM884SL.....    | 134 |                |     | 81200PXJSL.....   | 172 | 81943P.....       | 197 | 81971PXR.....     | 172 |
| FCM861XC.....     | 171 | FCM885SL.....    | 147 |                |     | 81200PXN.....     | 171 | 81943PSL.....     | 198 | 81973P.....       | 161 |
| FCM861XE.....     | 171 | FCM886SL.....    | 137 |                |     | 81200PXNSL.....   | 172 | 81943PXC.....     | 171 | 81974P.....       | 140 |
| FCM861XJ.....     | 171 | FCM886.....      | 146 |                |     | 81200PXR.....     | 171 | 81943PXCSSL.....  | 172 | 81975P.....       | 126 |
| FCM861XN.....     | 171 | FCM886SL.....    | 137 |                |     | 81200PXRSLSL..... | 172 | 81943PXE.....     | 171 | 81977P.....       | 129 |
| FCM861XR.....     | 171 | FCM887SL.....    | 137 |                |     | 81200SL.....      | 198 | 81943PXCSSL.....  | 172 | 81978P.....       | 132 |
| FCM862.....       | 196 | FCM888.....      | 142 |                |     | 81200XC.....      | 171 | 81943PXJ.....     | 171 | 81978P-A.....     | 132 |
| FCM862SL.....     | 197 | FCM888SL.....    | 142 |                |     | 81200XCSL.....    | 172 | 81943PXJSL.....   | 172 | 81980P.....       | 134 |
| FCM862XC.....     | 170 | FCM889SL.....    | 142 |                |     | 81200XE.....      | 171 | 81943PXN.....     | 171 | 81981P.....       | 143 |
| FCM862XCSSL.....  | 171 | FCM890.....      | 152 |                |     | 81200XESL.....    | 172 | 81943PXNSL.....   | 172 | 81982P.....       | 137 |
| FCM862XE.....     | 170 | FCM890SL.....    | 152 |                |     | 81200XJ.....      | 171 | 81943PXR.....     | 171 | 81983P.....       | 145 |

**Fiber-Classic.  
Oak Collection.**

|                 |     |
|-----------------|-----|
| 1000.....       | 201 |
| 1283.....       | 197 |
| 1284.....       | 187 |
| 1285.....       | 187 |
| 1286.....       | 174 |
| 1289.....       | 190 |
| 2000.....       | 182 |
| 2009.....       | 178 |
| 2010.....       | 177 |
| 2050.....       | 177 |
| 2100.....       | 182 |
| 2150.....       | 177 |
| 8000.....       | 182 |
| 81000.....      | 201 |
| 81200.....      | 197 |
| 81208.....      | 187 |
| 81225.....      | 174 |
| 81828.....      | 187 |
| 12101SL.....    | 198 |
| 12101XCSSL..... | 172 |
| 12101XESL.....  | 172 |
| 12101XJSL.....  | 172 |
| 12101XNSL.....  | 172 |
| 12101XRSL.....  | 172 |
| 12102SL.....    | 188 |
| 12102XCSSL..... | 168 |
| 12102XESL.....  | 168 |
| 12102XJSL.....  | 168 |
| 12102XNSL.....  | 168 |
| 12102XRSL.....  | 168 |

|                |     |                |     |                 |     |                 |     |               |     |                 |     |
|----------------|-----|----------------|-----|-----------------|-----|-----------------|-----|---------------|-----|-----------------|-----|
| 81984P.....    | 147 | FC125.....     | 147 | FC18XJ.....     | 168 | FC5425.....     | 174 | FC65XC.....   | 168 | FC802.....      | 129 |
| 81985P.....    | 152 | FC126.....     | 132 | FC18XJSL.....   | 168 | FC5425SL.....   | 175 | FC65XE.....   | 168 | FC803.....      | 197 |
| 81986PSL.....  | 143 | FC126-A.....   | 132 | FC18XN.....     | 168 | FC543.....      | 150 | FC65XJ.....   | 168 | FC803XC.....    | 172 |
| 81986SL.....   | 143 | FC127.....     | 147 | FC18XNSL.....   | 168 | FC545SL.....    | 150 | FC65XN.....   | 168 | FC803XE.....    | 172 |
| 81939P.....    | 137 | FC128.....     | 132 | FC18XR.....     | 168 | FC549.....      | 150 | FC65XR.....   | 168 | FC803XJ.....    | 172 |
| FC10.....      | 197 | FC1289SL.....  | 190 | FC18XRSL.....   | 168 | FC5700.....     | 178 | FC66.....     | 161 | FC803XN.....    | 172 |
| FC100.....     | 132 | FC128-A.....   | 132 | FC198.....      | 190 | FC5700SL.....   | 178 | FC668.....    | 129 | FC803XR.....    | 172 |
| FC1006.....    | 137 | FC129.....     | 126 | FC198SL.....    | 190 | FC5700XC.....   | 164 | FC669.....    | 161 | FC806.....      | 162 |
| FC100-A.....   | 132 | FC130.....     | 134 | FC20042.....    | 155 | FC5700XCSL..... | 164 | FC670.....    | 197 | FC807.....      | 188 |
| FC100SL.....   | 132 | FC131.....     | 132 | FC21.....       | 129 | FC5700XE.....   | 164 | FC678.....    | 174 | FC807SL.....    | 141 |
| FC100SL-A..... | 132 | FC131-A.....   | 132 | FC2101.....     | 187 | FC5700XESL..... | 164 | FC678SL.....  | 175 | FC807XC.....    | 168 |
| FC101.....     | 132 | FC131SL.....   | 132 | FC2101SL.....   | 189 | FC5700XJ.....   | 164 | FC701SL.....  | 198 | FC807XE.....    | 168 |
| FC101-A.....   | 132 | FC131SL-A..... | 132 | FC2102.....     | 187 | FC5700XJSL..... | 164 | FC704.....    | 190 | FC807XJ.....    | 168 |
| FC101SL.....   | 132 | FC132.....     | 197 | FC2106.....     | 187 | FC5700XN.....   | 164 | FC707.....    | 143 | FC807XN.....    | 168 |
| FC101SL-A..... | 132 | FC134.....     | 201 | FC2107.....     | 187 | FC5700XNSL..... | 164 | FC707SL.....  | 130 | FC807XR.....    | 168 |
| FC1027.....    | 140 | FC138.....     | 186 | FC2108.....     | 187 | FC5700XR.....   | 164 | FC708.....    | 197 | FC808.....      | 201 |
| FC1029.....    | 145 | FC138XC.....   | 167 | FC23.....       | 188 | FC5700XRSL..... | 164 | FC708XC.....  | 172 | FC808SL.....    | 126 |
| FC104.....     | 147 | FC138XE.....   | 167 | FC241.....      | 132 | FC571.....      | 150 | FC708XE.....  | 172 | FC809.....      | 200 |
| FC104SL.....   | 148 | FC138XJ.....   | 167 | FC241-A.....    | 132 | FC5710.....     | 178 | FC708XJ.....  | 172 | FC80920.....    | 197 |
| FC104XC.....   | 172 | FC138XN.....   | 167 | FC3000-2C.....  | 189 | FC5710SL.....   | 178 | FC708XN.....  | 172 | FC809203.....   | 188 |
| FC104XE.....   | 172 | FC138XR.....   | 167 | FC3000-3C.....  | 189 | FC5710XC.....   | 164 | FC708XR.....  | 172 | FC809203XC..... | 168 |
| FC104XJ.....   | 172 | FC1404.....    | 190 | FC3000-4C.....  | 189 | FC5710XCCL..... | 164 | FC709.....    | 156 | FC809203XE..... | 168 |
| FC104XN.....   | 172 | FC1400.....    | 190 | FC3000-6C.....  | 189 | FC5710XE.....   | 164 | FC710.....    | 197 | FC809203XJ..... | 168 |
| FC104XR.....   | 172 | FC1400SL.....  | 190 | FC31.....       | 200 | FC5710XESL..... | 164 | FC7125SL..... | 189 | FC809203XN..... | 168 |
| FC105.....     | 147 | FC1402.....    | 190 | FC310.....      | 125 | FC5710XJ.....   | 164 | FC713.....    | 147 | FC809203XR..... | 168 |
| FC105SL.....   | 148 | FC1408.....    | 190 | FC32.....       | 197 | FC5710XJSL..... | 164 | FC714.....    | 126 | FC80920XC.....  | 172 |
| FC108.....     | 125 | FC1408SL.....  | 190 | FC32SL.....     | 198 | FC5710XN.....   | 164 | FC721.....    | 148 | FC80920XE.....  | 172 |
| FC1089.....    | 187 | FC1409.....    | 178 | FC32XC.....     | 171 | FC5710XNSL..... | 164 | FC735.....    | 153 | FC80920XJ.....  | 172 |
| FC1089SL.....  | 189 | FC141.....     | 174 | FC32XCCL.....   | 172 | FC5710XR.....   | 164 | FC736.....    | 138 | FC80920XN.....  | 172 |
| FC108SL.....   | 126 | FC1411.....    | 190 | FC32XE.....     | 171 | FC5710XRSL..... | 164 | FC752.....    | 188 | FC80920XR.....  | 172 |
| FC109.....     | 125 | FC141SL.....   | 175 | FC32XESL.....   | 172 | FC5720.....     | 178 | FC755.....    | 201 | FC80941.....    | 129 |
| FC109SL.....   | 126 | FC142.....     | 145 | FC32XJ.....     | 171 | FC5720SL.....   | 178 | FC758.....    | 140 | FC80942.....    | 156 |
| FC10XC.....    | 171 | FC142SL.....   | 145 | FC32XJSL.....   | 172 | FC5720XC.....   | 164 | FC758SL.....  | 141 | FC80943.....    | 126 |
| FC10XE.....    | 171 | FC143.....     | 145 | FC32XN.....     | 171 | FC5720XCCL..... | 164 | FC761.....    | 140 | FC80945.....    | 162 |
| FC10XJ.....    | 171 | FC143SL.....   | 145 | FC32XNSL.....   | 172 | FC5720XE.....   | 164 | FC761SL.....  | 141 | FC80947.....    | 153 |
| FC10XN.....    | 171 | FC144.....     | 145 | FC32XR.....     | 171 | FC5720XESL..... | 164 | FC763.....    | 161 | FC80949.....    | 148 |
| FC10XR.....    | 171 | FC1442SL.....  | 156 | FC32XRSL.....   | 172 | FC5720XJ.....   | 164 | FC764.....    | 140 | FC80952.....    | 132 |
| FC11.....      | 161 | FC144SL.....   | 145 | FC3487SL.....   | 189 | FC5720XJSL..... | 164 | FC764SL.....  | 141 | FC80952-A.....  | 132 |
| FC113.....     | 134 | FC145.....     | 145 | FC3487XCCL..... | 168 | FC5720XN.....   | 164 | FC765.....    | 125 | FC80953.....    | 134 |
| FC113SL.....   | 135 | FC146.....     | 145 | FC3487XESL..... | 168 | FC5720XNSL..... | 164 | FC765SL.....  | 126 | FC80954.....    | 143 |
| FC114.....     | 134 | FC147.....     | 147 | FC3487XJSL..... | 168 | FC5720XR.....   | 164 | FC766.....    | 197 | FC80955.....    | 138 |
| FC114SL.....   | 135 | FC147SL.....   | 148 | FC3487XNSL..... | 168 | FC5720XRSL..... | 164 | FC766XC.....  | 171 | FC80956.....    | 141 |
| FC115.....     | 134 | FC148.....     | 155 | FC3487XRSL..... | 168 | FC572SL.....    | 150 | FC766XE.....  | 171 | FC80957.....    | 145 |
| FC115SL.....   | 135 | FC148SL.....   | 156 | FC369.....      | 134 | FC573SL.....    | 150 | FC766XJ.....  | 171 | FC809SL.....    | 153 |
| FC116.....     | 175 | FC149.....     | 155 | FC38.....       | 129 | FC574.....      | 150 | FC766XN.....  | 171 | FC8113SL.....   | 162 |
| FC118.....     | 134 | FC149SL.....   | 156 | FC38SL.....     | 130 | FC581.....      | 150 | FC766XR.....  | 171 | FC812SL.....    | 138 |
| FC1200.....    | 187 | FC150.....     | 156 | FC43.....       | 129 | FC583SL.....    | 150 | FC768.....    | 161 | FC813.....      | 161 |
| FC1200SL.....  | 188 | FC151.....     | 156 | FC43SL.....     | 130 | FC585.....      | 150 | FC769.....    | 140 | FC813SL.....    | 156 |
| FC1201.....    | 186 | FC152.....     | 155 | FC44.....       | 161 | FC60.....       | 201 | FC770.....    | 125 | FC814.....      | 129 |
| FC1201SL.....  | 188 | FC156.....     | 155 | FC44SL.....     | 162 | FC6093.....     | 142 | FC772.....    | 129 | FC8141.....     | 190 |
| FC1202.....    | 186 | FC16.....      | 129 | FC45.....       | 129 | FC6094.....     | 147 | FC773.....    | 132 | FC8144.....     | 190 |
| FC1202SL.....  | 188 | FC160.....     | 197 | FC46SL.....     | 129 | FC6095.....     | 152 | FC773-A.....  | 132 | FC8145.....     | 190 |
| FC1203.....    | 186 | FC163.....     | 147 | FC47SL.....     | 198 | FC61.....       | 198 | FC775.....    | 134 | FC8145SL.....   | 190 |
| FC1204.....    | 177 | FC164.....     | 126 | FC47XCCL.....   | 172 | FC61XC.....     | 172 | FC776.....    | 143 | FC8149.....     | 155 |
| FC1204SL.....  | 177 | FC1645.....    | 159 | FC47XESL.....   | 172 | FC61XE.....     | 172 | FC777.....    | 137 | FC814SL.....    | 135 |
| FC1205.....    | 177 | FC1646.....    | 158 | FC47XJSL.....   | 172 | FC61XJ.....     | 172 | FC778.....    | 145 | FC815SL.....    | 143 |
| FC1205SL.....  | 177 | FC1646SL.....  | 159 | FC47XNSL.....   | 172 | FC61XN.....     | 172 | FC779.....    | 147 | FC816.....      | 125 |
| FC1206.....    | 177 | FC1647.....    | 158 | FC47XRSL.....   | 172 | FC61XR.....     | 172 | FC780.....    | 152 | FC81645.....    | 159 |
| FC1206SL.....  | 177 | FC165.....     | 145 | FC48.....       | 197 | FC62.....       | 197 | FC782.....    | 140 | FC81646.....    | 158 |
| FC1207.....    | 177 | FC1651.....    | 158 | FC48SL.....     | 198 | FC626.....      | 155 | FC784.....    | 161 | FC81649.....    | 159 |
| FC1207XC.....  | 163 | FC1651SL.....  | 159 | FC48XC.....     | 172 | FC62XC.....     | 171 | FC785.....    | 140 | FC81651.....    | 158 |
| FC1207XE.....  | 163 | FC1652.....    | 158 | FC48XCCL.....   | 172 | FC62XE.....     | 171 | FC787.....    | 161 | FC81651SL.....  | 159 |
| FC1207XJ.....  | 163 | FC1652SL.....  | 159 | FC48XE.....     | 172 | FC62XJ.....     | 171 | FC788.....    | 140 | FC81652.....    | 158 |
| FC1207XN.....  | 163 | FC1654.....    | 158 | FC48XESL.....   | 172 | FC62XN.....     | 171 | FC789.....    | 197 | FC81652SL.....  | 159 |
| FC1207XR.....  | 163 | FC1655.....    | 159 | FC48XJ.....     | 172 | FC62XR.....     | 171 | FC791.....    | 162 | FC81653.....    | 159 |
| FC1208.....    | 187 | FC1656SL.....  | 159 | FC48XJSL.....   | 172 | FC63.....       | 188 | FC792.....    | 140 | FC81654.....    | 158 |
| FC1208SL.....  | 188 | FC1661.....    | 159 | FC48XN.....     | 172 | FC63SL.....     | 189 | FC794.....    | 126 | FC81654SL.....  | 159 |
| FC1209.....    | 186 | FC18.....      | 187 | FC48XNSL.....   | 172 | FC63XCCL.....   | 168 | FC795.....    | 145 | FC81646SL.....  | 159 |
| FC1209SL.....  | 188 | FC18SL.....    | 188 | FC48XR.....     | 172 | FC63XESL.....   | 168 | FC796.....    | 147 | FC816SL.....    | 132 |
| FC1211.....    | 186 | FC18XC.....    | 168 | FC48XRSL.....   | 172 | FC63XJSL.....   | 168 | FC797.....    | 153 | FC816SL-A.....  | 132 |
| FC1211SL.....  | 188 | FC18XCCL.....  | 168 | FC506.....      | 150 | FC63XNSL.....   | 168 | FC798.....    | 156 | FC817.....      | 134 |
| FC1212.....    | 186 | FC18XE.....    | 168 | FC507.....      | 150 | FC63XRSL.....   | 168 | FC800.....    | 141 | FC817SL.....    | 145 |
| FC124.....     | 129 | FC18XESL.....  | 168 | FC529.....      | 150 | FC65.....       | 188 | FC801.....    | 126 | FC818SL.....    | 148 |

|                |     |                |     |                   |     |                     |     |                 |     |               |     |
|----------------|-----|----------------|-----|-------------------|-----|---------------------|-----|-----------------|-----|---------------|-----|
| FC82.....      | 187 | FC86220XC..... | 172 | FC92XJSL.....     | 168 | FC082000XC-2C.....  | 163 | S1027.....      | 141 | S138SL.....   | 163 |
| FC820.....     | 152 | FC86220XE..... | 172 | FC92XN.....       | 168 | FC082000XC-3C.....  | 163 | S1029.....      | 145 | S139.....     | 132 |
| FC821.....     | 147 | FC86220XJ..... | 172 | FC92XNSL.....     | 168 | FC082000XC-4C.....  | 164 | S103.....       | 162 | S139-A.....   | 132 |
| FC822.....     | 132 | FC86220XN..... | 172 | FC92XR.....       | 168 | FC082000XC-6C.....  | 164 | S104.....       | 198 | S139SL.....   | 133 |
| FC822-A.....   | 132 | FC86220XR..... | 172 | FC92XRSL.....     | 168 | FC082000XE-2C.....  | 163 | S104XC.....     | 173 | S139SL-A..... | 133 |
| FC828.....     | 187 | FC86241.....   | 129 | FC02000-2C.....   | 177 | FC082000XE-3C.....  | 163 | S104XE.....     | 173 | S140.....     | 198 |
| FC82XC.....    | 168 | FC86242.....   | 156 | FC02000-3C.....   | 177 | FC082000XE-4C.....  | 164 | S104XJ.....     | 173 | S1400.....    | 195 |
| FC82XE.....    | 168 | FC86243.....   | 126 | FC02000-4C.....   | 177 | FC082000XE-6C.....  | 164 | S104XN.....     | 173 | S1400SL.....  | 196 |
| FC82XJ.....    | 168 | FC86245.....   | 162 | FC02000-6C.....   | 177 | FC082000XJ-2C.....  | 163 | S104XR.....     | 173 | S1401.....    | 181 |
| FC82XN.....    | 168 | FC86247.....   | 153 | FC02000XC-2C..... | 163 | FC082000XJ-3C.....  | 163 | S105.....       | 199 | S1401SL.....  | 181 |
| FC82XR.....    | 168 | FC86249.....   | 148 | FC02000XC-3C..... | 163 | FC082000XJ-4C.....  | 164 | S108.....       | 191 | S1402.....    | 195 |
| FC8310.....    | 187 | FC86252.....   | 132 | FC02000XC-4C..... | 164 | FC082000XJ-6C.....  | 164 | S1089.....      | 191 | S1404.....    | 195 |
| FC8310SL.....  | 189 | FC86252-A..... | 132 | FC02000XC-6C..... | 164 | FC082000XN-2C.....  | 163 | S1089SL.....    | 193 | S1405.....    | 195 |
| FC8311.....    | 187 | FC86253.....   | 135 | FC02000XE-2C..... | 163 | FC082000XN-3C.....  | 163 | S108XC.....     | 169 | S1405SL.....  | 196 |
| FC8311SL.....  | 189 | FC86254.....   | 143 | FC02000XE-3C..... | 163 | FC082000XN-4C.....  | 164 | S108XE.....     | 169 | S1406.....    | 195 |
| FC8313.....    | 187 | FC86255.....   | 138 | FC02000XE-4C..... | 164 | FC082000XN-6C.....  | 164 | S108XJ.....     | 169 | S1407.....    | 195 |
| FC8313SL.....  | 189 | FC86256.....   | 141 | FC02000XE-6C..... | 164 | FC082000XR-2C.....  | 163 | S108XN.....     | 169 | S1408.....    | 195 |
| FC8316.....    | 187 | FC86257.....   | 145 | FC02000XJ-2C..... | 163 | FC082000XR-3C.....  | 163 | S108XR.....     | 169 | S1409.....    | 181 |
| FC8318.....    | 188 | FC8675SL.....  | 189 | FC02000XJ-3C..... | 163 | FC082000XR-4C.....  | 164 | S11.....        | 201 | S140STC.....  | 200 |
| FC8319.....    | 188 | FC8678.....    | 174 | FC02000XJ-4C..... | 164 | FC082000XR-6C.....  | 164 | S115.....       | 193 | S140XC.....   | 172 |
| FC832.....     | 188 | FC8678SL.....  | 175 | FC02000XJ-6C..... | 164 | FC083000F-2C.....   | 189 | S1170SL.....    | 193 | S140XE.....   | 172 |
| FC8320.....    | 188 | FC8704.....    | 190 | FC02000XN-2C..... | 163 | FC083000F-3C.....   | 189 | S1170XCSSL..... | 169 | S140XJ.....   | 172 |
| FC8321.....    | 188 | FC8707.....    | 143 | FC02000XN-3C..... | 163 | FC083000F-4C.....   | 189 | S1170XESL.....  | 169 | S140XN.....   | 172 |
| FC8321XC.....  | 168 | FC8708.....    | 197 | FC02000XN-4C..... | 164 | FC083000F-6C.....   | 189 | S1170XJSL.....  | 169 | S140XR.....   | 172 |
| FC8321XE.....  | 168 | FC8708XC.....  | 172 | FC02000XN-6C..... | 164 | FC083000P-2C.....   | 189 | S1170XNSL.....  | 169 | S141.....     | 191 |
| FC8321XJ.....  | 168 | FC8708XE.....  | 172 | FC02000XR-2C..... | 163 | FC083000P-3C.....   | 189 | S1170XRSL.....  | 169 | S1411.....    | 195 |
| FC8321XN.....  | 168 | FC8708XJ.....  | 172 | FC02000XR-3C..... | 163 | FC083000P-4C.....   | 189 | S118.....       | 198 | S141STC.....  | 200 |
| FC8321XR.....  | 168 | FC8708XN.....  | 172 | FC02000XR-4C..... | 164 | FC083000P-6C.....   | 189 | S118XC.....     | 172 | S141XC.....   | 169 |
| FC8322.....    | 188 | FC8708XR.....  | 172 | FC02000XR-6C..... | 164 | <b>Smooth-Star.</b> |     | S118XE.....     | 172 | S141XE.....   | 169 |
| FC8323.....    | 188 | FC8721.....    | 148 | FC03000F-2C.....  | 189 | 19020T.....         | 196 | S118XJ.....     | 172 | S141XJ.....   | 169 |
| FC8324.....    | 188 | FC8735.....    | 153 | FC03000F-3C.....  | 189 | 19020T.....         | 199 | S118XN.....     | 172 | S141XN.....   | 169 |
| FC832XC.....   | 168 | FC8736.....    | 138 | FC03000F-4C.....  | 189 | 19055T.....         | 133 | S118XR.....     | 172 | S141XR.....   | 169 |
| FC832XE.....   | 168 | FC8752.....    | 188 | FC03000F-6C.....  | 189 | 19055T-A.....       | 133 | S12.....        | 133 | S1442SL.....  | 157 |
| FC832XJ.....   | 168 | FC8867SL.....  | 156 | FC06184SL.....    | 190 | 19080T.....         | 131 | S1200.....      | 191 | S150.....     | 198 |
| FC832XN.....   | 168 | FC89701.....   | 155 | FC06184XCSSL..... | 168 | 19200T.....         | 196 | S1200SL.....    | 193 | S150SL.....   | 199 |
| FC832XR.....   | 168 | FC8971.....    | 175 | FC06184XESL.....  | 168 | 19200T.....         | 199 | S1201.....      | 191 | S151.....     | 193 |
| FC8529.....    | 150 | FC8972.....    | 175 | FC06184XJSL.....  | 168 | 19200T.....         | 199 | S1201SL.....    | 193 | S151SL.....   | 194 |
| FC8545SL.....  | 150 | FC900.....     | 137 | FC06184XNSL.....  | 168 | 19210T.....         | 199 | S1202.....      | 191 | S154.....     | 143 |
| FC85700.....   | 178 | FC900SL.....   | 138 | FC06184XRSL.....  | 168 | 19220T.....         | 196 | S1202SL.....    | 193 | S154SL.....   | 144 |
| FC85700XC..... | 164 | FC901.....     | 137 | FC06185SL.....    | 190 | 19220T.....         | 199 | S1203.....      | 191 | S155.....     | 148 |
| FC85700XE..... | 164 | FC901SL.....   | 138 | FC06185XCSSL..... | 168 | 19520T.....         | 133 | S1204.....      | 179 | S155SL.....   | 149 |
| FC85700XJ..... | 164 | FC902.....     | 137 | FC06185XESL.....  | 168 | 19520T-A.....       | 133 | S1204SL.....    | 179 | S156.....     | 156 |
| FC85700XN..... | 164 | FC902SL.....   | 138 | FC06185XJSL.....  | 168 | 19720T.....         | 149 | S1205.....      | 179 | S160.....     | 156 |
| FC85700XR..... | 164 | FC903.....     | 137 | FC06185XNSL.....  | 168 | 19730T.....         | 149 | S1205SL.....    | 179 | S160SL.....   | 157 |
| FC8571.....    | 150 | FC904.....     | 138 | FC06185XRSL.....  | 168 | 19740T.....         | 144 | S1206.....      | 179 | S161.....     | 156 |
| FC85710.....   | 178 | FC905.....     | 142 | FC06186SL.....    | 190 | 19750T.....         | 144 | S1206SL.....    | 179 | S161SL.....   | 157 |
| FC85710XC..... | 164 | FC905SL.....   | 143 | FC06186XCSSL..... | 168 | 19800T.....         | 131 | S1207.....      | 179 | S162.....     | 156 |
| FC85710XE..... | 164 | FC906.....     | 143 | FC06186XESL.....  | 168 | 19810T.....         | 131 | S1207XC.....    | 164 | S163.....     | 157 |
| FC85710XJ..... | 164 | FC906SL.....   | 143 | FC06186XJSL.....  | 168 | 19820T.....         | 131 | S1207XE.....    | 164 | S1645.....    | 160 |
| FC85710XN..... | 164 | FC907.....     | 143 | FC06186XNSL.....  | 168 | 85901SL.....        | 146 | S1207XJ.....    | 164 | S1646.....    | 159 |
| FC85710XR..... | 164 | FC907SL.....   | 143 | FC06186XRSL.....  | 168 | 85919SL.....        | 146 | S1207XN.....    | 164 | S1646SL.....  | 160 |
| FC85720.....   | 178 | FC908.....     | 143 | FC06188SL.....    | 190 | AVRT.....           | 142 | S1207XR.....    | 164 | S1647.....    | 159 |
| FC85720XC..... | 164 | FC909.....     | 143 | FC06188XCSSL..... | 168 | AXRT.....           | 160 | S1208.....      | 191 | S1650.....    | 159 |
| FC85720XE..... | 164 | FC910.....     | 152 | FC06188XESL.....  | 168 | BLHRT.....          | 131 | S1208SL.....    | 193 | S1651.....    | 159 |
| FC85720XJ..... | 164 | FC910SL.....   | 153 | FC06188XJSL.....  | 168 | BSHRT.....          | 127 | S1209.....      | 191 | S1651SL.....  | 160 |
| FC85720XN..... | 164 | FC911.....     | 152 | FC06188XRSL.....  | 168 | BSRT.....           | 127 | S1209SL.....    | 193 | S1652.....    | 159 |
| FC85720XR..... | 164 | FC911SL.....   | 153 | FC06189SL.....    | 190 | CNHRT.....          | 154 | S1211.....      | 191 | S1652SL.....  | 160 |
| FC8572SL.....  | 150 | FC912.....     | 152 | FC06189XCSSL..... | 168 | CNRT.....           | 154 | S1211SL.....    | 193 | S1653.....    | 159 |
| FC8573SL.....  | 150 | FC912SL.....   | 153 | FC06189XESL.....  | 168 | DLHRT.....          | 199 | S1212.....      | 191 | S1654.....    | 159 |
| FC8574.....    | 150 | FC913.....     | 153 | FC06189XJSL.....  | 168 | FWRT.....           | 139 | S128.....       | 191 | S1655.....    | 159 |
| FC8579.....    | 150 | FC914.....     | 153 | FC06189XNSL.....  | 168 | KNRT.....           | 157 | S128XC.....     | 169 | S1656.....    | 159 |
| FC8581.....    | 150 | FC915.....     | 153 | FC06189XRSL.....  | 168 | RSRT.....           | 151 | S128XE.....     | 169 | S1656SL.....  | 160 |
| FC8583SL.....  | 150 | FC916.....     | 153 | FC06190SL.....    | 190 | S10.....            | 199 | S128XJ.....     | 169 | S1658.....    | 159 |
| FC860.....     | 201 | FC916SL.....   | 153 | FC06190XCSSL..... | 168 | S100.....           | 201 | S128XN.....     | 169 | S1661.....    | 160 |
| FC861.....     | 198 | FC917.....     | 153 | FC06190XESL.....  | 168 | S1000.....          | 154 | S128XR.....     | 169 | S17.....      | 154 |
| FC861XC.....   | 172 | FC92.....      | 187 | FC06190XJSL.....  | 168 | S1001.....          | 157 | S12-A.....      | 133 | S198.....     | 195 |
| FC861XE.....   | 172 | FC925.....     | 175 | FC06190XNSL.....  | 168 | S1006.....          | 138 | S130.....       | 175 | S198SL.....   | 196 |
| FC861XJ.....   | 172 | FC92SL.....    | 189 | FC06190XRSL.....  | 168 | S100SL.....         | 199 | S130SL.....     | 176 | S20.....      | 144 |
| FC861XN.....   | 172 | FC92XC.....    | 168 | FC082000-2C.....  | 177 | S100XCSSL.....      | 173 | S131.....       | 176 | S200.....     | 201 |
| FC861XR.....   | 172 | FC92XCSSL..... | 168 | FC082000-3C.....  | 177 | S100XESL.....       | 173 | S132.....       | 175 | S2000.....    | 182 |
| FC862.....     | 200 | FC92XE.....    | 168 | FC082000-4C.....  | 177 | S100XJSL.....       | 173 | S132SL.....     | 176 | S2000-2C..... | 180 |
| FC86220.....   | 197 | FC92XESL.....  | 168 | FC082000-6C.....  | 177 | S100XNSL.....       | 173 | S137.....       | 176 | S2000-3C..... | 180 |
| FC862203.....  | 188 | FC92XJ.....    | 168 |                   |     | S100XRSL.....       | 173 | S138.....       | 162 | S2000-4C..... | 180 |



|                    |     |                |     |                 |     |                 |     |                |     |                |     |
|--------------------|-----|----------------|-----|-----------------|-----|-----------------|-----|----------------|-----|----------------|-----|
| S2000-6C.....      | 180 | S2106.....     | 191 | S3000F-4C.....  | 194 | S4813XE.....    | 165 | S6000.....     | 126 | S604SL-A.....  | 133 |
| S2000SL.....       | 182 | S2107.....     | 191 | S3000F-6C.....  | 194 | S4813XJ.....    | 165 | S6000SL.....   | 127 | S605.....      | 194 |
| S2000SL-2C.....    | 181 | S2108.....     | 191 | S308SL.....     | 193 | S4813XN.....    | 165 | S6002.....     | 126 | S6050.....     | 148 |
| S2000SL-4C.....    | 181 | S210SL.....    | 199 | S308XCSL.....   | 169 | S4813XR.....    | 165 | S6002SL.....   | 127 | S6051.....     | 136 |
| S2000XC.....       | 166 | S210XCSSL..... | 173 | S308XESL.....   | 169 | S4814.....      | 181 | S6006.....     | 136 | S6052.....     | 127 |
| S2000XC-2C.....    | 164 | S210XESL.....  | 173 | S308XJSL.....   | 169 | S4814XC.....    | 165 | S6006SL.....   | 136 | S6054.....     | 176 |
| S2000XC-3C.....    | 164 | S210XJSL.....  | 173 | S308XNSL.....   | 169 | S4814XE.....    | 165 | S6008.....     | 136 | S6055.....     | 176 |
| S2000XC-4C.....    | 164 | S210XNSL.....  | 173 | S308XRSL.....   | 169 | S4814XJ.....    | 165 | S6008SL.....   | 136 | S6056.....     | 156 |
| S2000XC-6C.....    | 165 | S210XRSL.....  | 173 | S30XC.....      | 173 | S4814XN.....    | 165 | S6009.....     | 136 | S605SL.....    | 195 |
| S2000XCSSL.....    | 166 | S211.....      | 133 | S30XE.....      | 173 | S4814XR.....    | 165 | S6009SL.....   | 136 | S605XC.....    | 170 |
| S2000XCSSL-2C..... | 165 | S211-A.....    | 133 | S30XJ.....      | 173 | S4816.....      | 181 | S601.....      | 199 | S605XCSSL..... | 170 |
| S2000XCSSL-4C..... | 165 | S213.....      | 143 | S30XN.....      | 173 | S4816XC.....    | 165 | S6010.....     | 136 | S605XE.....    | 170 |
| S2000XE.....       | 166 | S214.....      | 148 | S30XR.....      | 173 | S4816XE.....    | 165 | S6011.....     | 136 | S605XESL.....  | 170 |
| S2000XE-2C.....    | 164 | S2150.....     | 179 | S31.....        | 201 | S4816XJ.....    | 165 | S6013.....     | 127 | S605XJ.....    | 170 |
| S2000XE-3C.....    | 164 | S220.....      | 201 | S310.....       | 126 | S4816XN.....    | 165 | S6014.....     | 136 | S605XJSL.....  | 170 |
| S2000XE-4C.....    | 164 | S2200.....     | 182 | S32.....        | 193 | S4816XR.....    | 165 | S601SL.....    | 199 | S605XN.....    | 170 |
| S2000XE-6C.....    | 165 | S2250.....     | 179 | S32XC.....      | 169 | S506.....       | 151 | S601XC.....    | 173 | S605XNSL.....  | 170 |
| S2000XESL.....     | 166 | S236.....      | 193 | S32XE.....      | 169 | S507.....       | 151 | S601XCSSL..... | 173 | S605XR.....    | 170 |
| S2000XESL-2C.....  | 165 | S237.....      | 193 | S32XJ.....      | 169 | S508.....       | 151 | S601XE.....    | 173 | S605XRSL.....  | 170 |
| S2000XESL-4C.....  | 165 | S241.....      | 132 | S32XN.....      | 169 | S529.....       | 151 | S601XESL.....  | 173 | S606.....      | 194 |
| S2000XJ.....       | 166 | S241-A.....    | 132 | S32XR.....      | 169 | S5425.....      | 175 | S601XJ.....    | 173 | S6061.....     | 175 |
| S2000XJ-2C.....    | 164 | S243.....      | 176 | S34.....        | 162 | S5425SL.....    | 176 | S601XJSL.....  | 173 | S6062.....     | 195 |
| S2000XJ-3C.....    | 164 | S250.....      | 162 | S3487SL.....    | 194 | S543.....       | 150 | S601XN.....    | 173 | S6062SL.....   | 196 |
| S2000XJ-4C.....    | 164 | S250SL.....    | 163 | S3487XCSL.....  | 169 | S545SL.....     | 151 | S601XNSL.....  | 173 | S6063.....     | 191 |
| S2000XJ-6C.....    | 165 | S255.....      | 193 | S3487XESL.....  | 169 | S549.....       | 151 | S601XR.....    | 173 | S6063XC.....   | 169 |
| S2000XJSL.....     | 166 | S256.....      | 199 | S3487XJSL.....  | 169 | S5700.....      | 181 | S601XRSL.....  | 173 | S6063XE.....   | 169 |
| S2000XJSL-2C.....  | 165 | S256XC.....    | 173 | S3487XNSL.....  | 169 | S5700SL.....    | 181 | S602.....      | 144 | S6063XJ.....   | 169 |
| S2000XJSL-4C.....  | 165 | S256XE.....    | 173 | S3487XRSL.....  | 169 | S5700XC.....    | 165 | S6021.....     | 198 | S6063XN.....   | 169 |
| S2000XN.....       | 166 | S256XJ.....    | 173 | S35.....        | 133 | S5700XCSSL..... | 166 | S6021XC.....   | 172 | S6063XR.....   | 169 |
| S2000XN-2C.....    | 164 | S256XN.....    | 173 | S35-A.....      | 133 | S5700XE.....    | 165 | S6021XE.....   | 172 | S606SL.....    | 195 |
| S2000XN-3C.....    | 164 | S256XR.....    | 173 | S369.....       | 136 | S5700XESL.....  | 166 | S6021XJ.....   | 172 | S606XC.....    | 170 |
| S2000XN-4C.....    | 164 | S260.....      | 163 | S37.....        | 154 | S5700XJ.....    | 165 | S6021XN.....   | 172 | S606XCSSL..... | 170 |
| S2000XN-6C.....    | 165 | S262.....      | 192 | S38.....        | 130 | S5700XJSL.....  | 166 | S6021XR.....   | 172 | S606XE.....    | 170 |
| S2000XNSL.....     | 166 | S262XC.....    | 169 | S400.....       | 154 | S5700XN.....    | 165 | S6022.....     | 192 | S606XESL.....  | 170 |
| S2000XNSL-2C.....  | 165 | S262XE.....    | 169 | S4070SL.....    | 154 | S5700XNSL.....  | 166 | S6022XC.....   | 169 | S606XJ.....    | 170 |
| S2000XNSL-4C.....  | 165 | S262XJ.....    | 169 | S41.....        | 144 | S5700XR.....    | 165 | S6022XE.....   | 169 | S606XJSL.....  | 170 |
| S2000XR.....       | 166 | S262XN.....    | 169 | S416SL.....     | 154 | S5700XRSL.....  | 166 | S6022XJ.....   | 169 | S606XN.....    | 170 |
| S2000XR-2C.....    | 164 | S262XR.....    | 169 | S42.....        | 148 | S571.....       | 150 | S6022XN.....   | 169 | S606XNSL.....  | 170 |
| S2000XR-3C.....    | 164 | S263SL.....    | 194 | S426.....       | 153 | S5710.....      | 181 | S6022XR.....   | 169 | S606XR.....    | 170 |
| S2000XR-4C.....    | 164 | S263XCSL.....  | 169 | S43.....        | 156 | S5710SL.....    | 182 | S6023.....     | 162 | S606XRSL.....  | 170 |
| S2000XR-6C.....    | 165 | S263XESL.....  | 169 | S430.....       | 154 | S5710XC.....    | 165 | S6025.....     | 133 | S607.....      | 194 |
| S2000XRSL.....     | 166 | S263XJSL.....  | 169 | S430SL.....     | 154 | S5710XCSSL..... | 166 | S6025-A.....   | 133 | S6070.....     | 145 |
| S2000XRSL-2C.....  | 165 | S263XNSL.....  | 169 | S450.....       | 154 | S5710XE.....    | 165 | S6026.....     | 153 | S6070SL.....   | 146 |
| S2000XRSL-4C.....  | 165 | S263XRSL.....  | 169 | S450SL.....     | 154 | S5710XESL.....  | 166 | S60274.....    | 130 | S6071.....     | 145 |
| S20042.....        | 156 | S289.....      | 198 | S454.....       | 154 | S5710XJ.....    | 165 | S6029.....     | 143 | S6071SL.....   | 146 |
| S2009.....         | 181 | S289E.....     | 162 | S4570SL.....    | 127 | S5710XJSL.....  | 166 | S602SL.....    | 144 | S6072.....     | 146 |
| S2009SL.....       | 181 | S289ESL.....   | 163 | S4800.....      | 201 | S5710XN.....    | 165 | S6030.....     | 148 | S6073.....     | 146 |
| S2010.....         | 179 | S289XC.....    | 173 | S4810.....      | 182 | S5710XNSL.....  | 166 | S6031.....     | 136 | S6073SL.....   | 146 |
| S2010XCSSL.....    | 164 | S289XE.....    | 173 | S4810SL.....    | 182 | S5710XR.....    | 165 | S6032.....     | 126 | S6074.....     | 146 |
| S2010XESL.....     | 164 | S289XJ.....    | 173 | S4810XC.....    | 166 | S5710XRSL.....  | 166 | S6034.....     | 176 | S6075.....     | 146 |
| S2010XJSL.....     | 164 | S289XN.....    | 173 | S4810XCSSL..... | 166 | S5720.....      | 181 | S6035.....     | 176 | S6076.....     | 146 |
| S2010XNSL.....     | 164 | S289XR.....    | 173 | S4810XE.....    | 166 | S5720SL.....    | 182 | S6036.....     | 156 | S6077.....     | 146 |
| S2010XRSL.....     | 164 | S291.....      | 144 | S4810XESL.....  | 166 | S5720XC.....    | 165 | S604.....      | 133 | S6078.....     | 146 |
| S205.....          | 201 | S291SL.....    | 144 | S4810XJ.....    | 166 | S5720XE.....    | 165 | S6041.....     | 198 | S6079.....     | 146 |
| S2050.....         | 179 | S292.....      | 148 | S4810XJSL.....  | 166 | S5720XJ.....    | 165 | S6041XC.....   | 173 | S607SL.....    | 195 |
| S206.....          | 198 | S292SL.....    | 149 | S4810XN.....    | 166 | S5720XN.....    | 165 | S6041XE.....   | 173 | S607XC.....    | 170 |
| S206E.....         | 162 | S294.....      | 133 | S4810XNSL.....  | 166 | S5720XR.....    | 165 | S6041XJ.....   | 173 | S607XCSSL..... | 170 |
| S206XC.....        | 172 | S294-A.....    | 133 | S4810XR.....    | 166 | S572SL.....     | 151 | S6041XN.....   | 173 | S607XE.....    | 170 |
| S206XE.....        | 172 | S294SL.....    | 133 | S4810XRSL.....  | 166 | S5720XCSSL..... | 166 | S6041XR.....   | 173 | S607XESL.....  | 170 |
| S206XJ.....        | 172 | S294SL-A.....  | 133 | S4812.....      | 180 | S5720XESL.....  | 166 | S6042.....     | 192 | S607XJ.....    | 170 |
| S206XN.....        | 172 | S296.....      | 199 | S4812SL.....    | 181 | S5720XJSL.....  | 166 | S6042XC.....   | 169 | S607XJSL.....  | 170 |
| S206XR.....        | 172 | S296XC.....    | 173 | S4812XC.....    | 165 | S5720XNSL.....  | 166 | S6042XE.....   | 169 | S607XN.....    | 170 |
| S2070SL.....       | 163 | S296XE.....    | 173 | S4812XCSSL..... | 165 | S5720XRSL.....  | 166 | S6042XJ.....   | 169 | S607XNSL.....  | 170 |
| S210.....          | 201 | S296XJ.....    | 173 | S4812XE.....    | 165 | S5730.....      | 181 | S6042XN.....   | 169 | S607XR.....    | 170 |
| S2100.....         | 182 | S296XN.....    | 173 | S4812XESL.....  | 165 | S573SL.....     | 151 | S6042XR.....   | 169 | S607XRSL.....  | 170 |
| S2101.....         | 191 | S296XR.....    | 173 | S4812XJ.....    | 165 | S574.....       | 150 | S6043.....     | 162 | S608.....      | 195 |
| S2101SL.....       | 193 | S30.....       | 198 | S4812XJSL.....  | 165 | S575.....       | 151 | S6045.....     | 133 | S6080.....     | 199 |
| S2102.....         | 191 | S3000-2C.....  | 194 | S4812XN.....    | 165 | S579.....       | 151 | S6045-A.....   | 133 | S6081.....     | 162 |
| S2103.....         | 179 | S3000-3C.....  | 194 | S4812XNSL.....  | 165 | S581.....       | 151 | S6046.....     | 154 | S6082.....     | 148 |
| S2103SL.....       | 179 | S3000-4C.....  | 194 | S4812XR.....    | 165 | S583SL.....     | 151 | S6047.....     | 130 | S6084.....     | 154 |
| S2104.....         | 179 | S3000-6C.....  | 194 | S4812XRSL.....  | 165 | S585.....       | 151 | S6049.....     | 143 | S6085.....     | 127 |
| S2104SL.....       | 179 | S3000F-2C..... | 194 | S4813.....      | 180 | S5870SL.....    | 149 | S604-A.....    | 133 | S608XC.....    | 170 |
| S2105.....         | 179 | S3000F-3C..... | 194 | S4813XC.....    | 165 | S600.....       | 201 | S604SL.....    | 133 | S608XE.....    | 170 |

|                 |     |                  |     |                  |     |                  |     |                 |     |                  |     |
|-----------------|-----|------------------|-----|------------------|-----|------------------|-----|-----------------|-----|------------------|-----|
| S608XJ.....     | 170 | S7125SL.....     | 194 | S8140XE.....     | 172 | S82000XR-2C..... | 164 | S82SL.....      | 193 | S832XE.....      | 169 |
| S608XN.....     | 170 | S721.....        | 149 | S8140XJ.....     | 172 | S82000XR-3C..... | 164 | S82XC.....      | 169 | S832XJ.....      | 169 |
| S608XR.....     | 170 | S735.....        | 154 | S8140XN.....     | 172 | S82000XR-4C..... | 164 | S82XCSSL.....   | 169 | S832XN.....      | 169 |
| S609.....       | 138 | S736.....        | 139 | S8140XR.....     | 172 | S82000XR-6C..... | 165 | S82XE.....      | 169 | S832XR.....      | 169 |
| S6090.....      | 153 | S751SL.....      | 199 | S8141.....       | 195 | S8202.....       | 194 | S82XESL.....    | 169 | S833.....        | 133 |
| S6091.....      | 148 | S751XCSSL.....   | 173 | S8144.....       | 195 | S8202SL.....     | 195 | S82XJ.....      | 169 | S833-A.....      | 133 |
| S6091SL.....    | 149 | S751XESL.....    | 173 | S8145.....       | 195 | S8203.....       | 194 | S82XJSL.....    | 169 | S834.....        | 162 |
| S6092.....      | 143 | S751XJSL.....    | 173 | S8145SL.....     | 196 | S8204.....       | 194 | S82XN.....      | 169 | S837.....        | 154 |
| S6092SL.....    | 144 | S751XNSL.....    | 173 | S8149.....       | 156 | S8204SL.....     | 195 | S82XNSL.....    | 169 | S84.....         | 162 |
| S6093.....      | 143 | S751XRSL.....    | 173 | S8145L.....      | 130 | S8205.....       | 194 | S82XR.....      | 169 | S84586SL.....    | 131 |
| S6094.....      | 148 | S752.....        | 193 | S815.....        | 130 | S8207SL.....     | 195 | S82XRSL.....    | 169 | S84800.....      | 201 |
| S6095.....      | 153 | S755.....        | 201 | S816.....        | 126 | S820.....        | 148 | S830.....       | 198 | S84810.....      | 182 |
| S6097.....      | 192 | S757SL.....      | 154 | S81645.....      | 160 | S821.....        | 153 | S83000-2C.....  | 194 | S84810SL.....    | 182 |
| S6100.....      | 138 | S758SL.....      | 131 | S81646.....      | 159 | S821.....        | 201 | S83000-3C.....  | 194 | S84810XC.....    | 166 |
| S6100SL.....    | 139 | S761SL.....      | 199 | S81646SL.....    | 160 | S82103.....      | 179 | S83000-4C.....  | 194 | S84810XCSSL..... | 166 |
| S6101.....      | 138 | S767SL.....      | 154 | S81649.....      | 160 | S82104.....      | 179 | S83000-6C.....  | 194 | S84810XE.....    | 166 |
| S6101SL.....    | 139 | S768SL.....      | 131 | S81650.....      | 159 | S82105.....      | 179 | S83000F-2C..... | 194 | S84810XESL.....  | 166 |
| S6102.....      | 138 | S770.....        | 198 | S81651.....      | 159 | S82105XC.....    | 164 | S83000F-3C..... | 194 | S84810XJ.....    | 166 |
| S6102SL.....    | 139 | S771.....        | 127 | S81651SL.....    | 160 | S82105XE.....    | 164 | S83000F-4C..... | 194 | S84810XJSL.....  | 166 |
| S6103.....      | 138 | S773.....        | 154 | S81652.....      | 159 | S82105XJ.....    | 164 | S83000F-6C..... | 194 | S84810XN.....    | 166 |
| S6104.....      | 138 | S774.....        | 148 | S81652SL.....    | 160 | S82105XN.....    | 164 | S830XC.....     | 173 | S84810XNSL.....  | 166 |
| S6105.....      | 138 | S80.....         | 198 | S81653.....      | 159 | S82105XR.....    | 164 | S830XE.....     | 173 | S84810XR.....    | 166 |
| S6106.....      | 138 | S8000.....       | 182 | S81654.....      | 159 | S82106.....      | 179 | S830XJ.....     | 173 | S84810XRSL.....  | 166 |
| S6107.....      | 138 | S8000-12.....    | 179 | S81654SL.....    | 160 | S82106XC.....    | 164 | S830XN.....     | 173 | S84812.....      | 180 |
| S6108.....      | 138 | S8000-18.....    | 179 | S817.....        | 136 | S82106XE.....    | 164 | S830XR.....     | 173 | S84812SL.....    | 181 |
| S6111.....      | 127 | S8000-9.....     | 181 | S818.....        | 198 | S82106XJ.....    | 164 | S831.....       | 201 | S84812XC.....    | 165 |
| S6113.....      | 130 | S8000SL.....     | 182 | S81828.....      | 191 | S82106XN.....    | 164 | S8310.....      | 192 | S84812XCSSL..... | 165 |
| S6117.....      | 148 | S8000XC.....     | 166 | S818XC.....      | 172 | S82106XR.....    | 164 | S8310SL.....    | 193 | S84812XE.....    | 165 |
| S6119.....      | 157 | S8000XCSSL.....  | 166 | S818XE.....      | 172 | S82107.....      | 179 | S8311.....      | 191 | S84812XESL.....  | 165 |
| S6121.....      | 141 | S8000XE.....     | 166 | S818XJ.....      | 172 | S82107XC.....    | 164 | S8311SL.....    | 193 | S84812XJ.....    | 165 |
| S6123.....      | 130 | S8000XESL.....   | 166 | S818XN.....      | 172 | S82107XE.....    | 164 | S83120.....     | 199 | S84812XJSL.....  | 165 |
| S6123.....      | 136 | S8000XJ.....     | 166 | S818XR.....      | 172 | S82107XJ.....    | 164 | S831203.....    | 193 | S84812XN.....    | 165 |
| S6124SL.....    | 195 | S8000XJSL.....   | 166 | S81929P.....     | 198 | S82107XN.....    | 164 | S831203XC.....  | 169 | S84812XNSL.....  | 165 |
| S6124XCSSL..... | 170 | S8000XN.....     | 166 | S81929PXC.....   | 172 | S82107XR.....    | 164 | S831203XE.....  | 169 | S84812XR.....    | 165 |
| S6124XESL.....  | 170 | S8000XNSL.....   | 166 | S81929PXE.....   | 172 | S82112.....      | 180 | S831203XJ.....  | 169 | S84812XRSL.....  | 165 |
| S6124XJSL.....  | 170 | S8000XR.....     | 166 | S81929PJ.....    | 172 | S82112XC.....    | 165 | S831203XN.....  | 169 | S84813.....      | 180 |
| S6124XNSL.....  | 170 | S8000XRSL.....   | 166 | S81929PXN.....   | 172 | S82112XE.....    | 165 | S831203XR.....  | 169 | S84813XC.....    | 165 |
| S6124XRSL.....  | 170 | S807.....        | 193 | S81929PXR.....   | 172 | S82112XJ.....    | 165 | S83120XC.....   | 173 | S84813XE.....    | 165 |
| S6125SL.....    | 195 | S807XC.....      | 169 | S81931P.....     | 162 | S82112XN.....    | 165 | S83120XE.....   | 173 | S84813XJ.....    | 165 |
| S6125XCSSL..... | 170 | S807XE.....      | 169 | S81932P.....     | 141 | S82112XR.....    | 165 | S83120XJ.....   | 173 | S84813XN.....    | 165 |
| S6125XESL.....  | 170 | S807XJ.....      | 169 | S81933P.....     | 126 | S82113.....      | 180 | S83120XN.....   | 173 | S84813XR.....    | 165 |
| S6125XJSL.....  | 170 | S807XN.....      | 169 | S81935P.....     | 130 | S82113XC.....    | 165 | S83120XR.....   | 173 | S84814.....      | 181 |
| S6125XNSL.....  | 170 | S807XR.....      | 169 | S81936P-A.....   | 133 | S82113XE.....    | 165 | S8313.....      | 191 | S84814XC.....    | 165 |
| S6125XRSL.....  | 170 | S808.....        | 191 | S81937P.....     | 136 | S82113XJ.....    | 165 | S8313SL.....    | 193 | S84814XE.....    | 165 |
| S6126SL.....    | 195 | S808SL.....      | 193 | S81938P.....     | 143 | S82113XN.....    | 165 | S83141.....     | 130 | S84814XJ.....    | 165 |
| S6126XCSSL..... | 170 | S80XC.....       | 172 | S81939P.....     | 133 | S82113XR.....    | 165 | S83142.....     | 157 | S84814XN.....    | 165 |
| S6126XESL.....  | 170 | S80XE.....       | 172 | S81939P.....     | 138 | S82114.....      | 180 | S83143.....     | 127 | S84814XR.....    | 165 |
| S6126XJSL.....  | 170 | S80XJ.....       | 172 | S81940P.....     | 146 | S82114XC.....    | 165 | S83145.....     | 163 | S84816.....      | 181 |
| S6126XNSL.....  | 170 | S80XN.....       | 172 | S81941P.....     | 148 | S82114XE.....    | 165 | S83147.....     | 154 | S84816XC.....    | 165 |
| S6126XRSL.....  | 170 | S80XR.....       | 172 | S81942P.....     | 153 | S82114XJ.....    | 165 | S83149.....     | 148 | S84816XE.....    | 165 |
| S6127SL.....    | 142 | S810.....        | 201 | S81983.....      | 146 | S82114XN.....    | 165 | S83152.....     | 133 | S84816XJ.....    | 165 |
| S6128SL.....    | 176 | S81000.....      | 201 | S82.....         | 191 | S82114XR.....    | 165 | S83152-A.....   | 133 | S84816XN.....    | 165 |
| S6130SL.....    | 131 | S81086SL.....    | 199 | S8200.....       | 201 | S82116.....      | 180 | S83153.....     | 136 | S84816XR.....    | 165 |
| S6131SL.....    | 139 | S81086XCSSL..... | 173 | S82000-2C.....   | 180 | S82116XC.....    | 165 | S83154.....     | 144 | S84886SL.....    | 179 |
| S6132SL.....    | 157 | S81086XESL.....  | 173 | S82000-3C.....   | 180 | S82116XE.....    | 165 | S83155.....     | 138 | S84886XCSSL..... | 164 |
| S6134SL.....    | 136 | S81086XJSL.....  | 173 | S82000-4C.....   | 180 | S82116XJ.....    | 165 | S83156.....     | 142 | S84886XESL.....  | 164 |
| S6135SL.....    | 146 | S81086XNSL.....  | 173 | S82000-6C.....   | 180 | S82116XN.....    | 165 | S83157.....     | 146 | S84886XJSL.....  | 164 |
| S626.....       | 156 | S81086XRSL.....  | 173 | S82000XC-2C..... | 164 | S82116XR.....    | 165 | S8316.....      | 191 | S84886XNSL.....  | 164 |
| S63.....        | 192 | S811.....        | 192 | S82000XC-3C..... | 164 | S82200.....      | 182 | S8317.....      | 193 | S84886XRSL.....  | 164 |
| S663STC.....    | 200 | S8113SL.....     | 163 | S82000XC-4C..... | 164 | S82200XC.....    | 166 | S8318.....      | 192 | S8508.....       | 151 |
| S668.....       | 130 | S81186SL.....    | 193 | S82000XC-6C..... | 165 | S82200XE.....    | 166 | S8319.....      | 192 | S8529.....       | 151 |
| S669.....       | 162 | S812.....        | 162 | S82000XE-2C..... | 164 | S82200XJ.....    | 166 | S832.....       | 193 | S8545SL.....     | 151 |
| S682.....       | 175 | S81208.....      | 191 | S82000XE-3C..... | 164 | S82200XN.....    | 166 | S8320.....      | 193 | S85700.....      | 181 |
| S704.....       | 195 | S81225.....      | 175 | S82000XE-4C..... | 164 | S82200XR.....    | 166 | S8321.....      | 192 | S85700SL.....    | 181 |
| S707.....       | 144 | S813.....        | 162 | S82000XE-6C..... | 165 | S82250.....      | 179 | S8321XC.....    | 169 | S85700XC.....    | 165 |
| S708.....       | 199 | S81300SL.....    | 163 | S82000XJ-2C..... | 164 | S822XC.....      | 169 | S8321XE.....    | 169 | S85700XCSSL..... | 166 |
| S708XC.....     | 173 | S8132.....       | 175 | S82000XJ-3C..... | 164 | S822XE.....      | 169 | S8321XJ.....    | 169 | S85700XE.....    | 165 |
| S708XE.....     | 173 | S8132SL.....     | 176 | S82000XJ-4C..... | 164 | S822XJ.....      | 169 | S8321XN.....    | 169 | S85700XESL.....  | 166 |
| S708XJ.....     | 173 | S814.....        | 130 | S82000XJ-6C..... | 165 | S822XN.....      | 169 | S8321XR.....    | 169 | S85700XJ.....    | 165 |
| S708XN.....     | 173 | S8140.....       | 198 | S82000XN-2C..... | 164 | S822XR.....      | 169 | S8322.....      | 192 | S85700XJSL.....  | 166 |
| S708XR.....     | 173 | S81401.....      | 181 | S82000XN-3C..... | 164 | S828.....        | 191 | S8323.....      | 192 | S85700XN.....    | 165 |
| S709.....       | 156 | S8140STC.....    | 200 | S82000XN-4C..... | 164 | S829.....        | 175 | S8324.....      | 192 | S85700XNSL.....  | 166 |
|                 |     | S8140XC.....     | 172 | S82000XN-6C..... | 165 | S829SL.....      | 176 | S832XC.....     | 169 | S85700XR.....    | 165 |

# Steel

|                  |     |                 |     |               |     |               |     |                   |               |     |
|------------------|-----|-----------------|-----|---------------|-----|---------------|-----|-------------------|---------------|-----|
| S85700XRSL.....  | 166 | S85928SL.....   | 176 | S880XC.....   | 172 | S92XE.....    | 169 | <b>Profiles..</b> | 1045HD.....   | 211 |
| S8571.....       | 150 | S85930SL.....   | 154 | S880XCSL..... | 173 | S92XJ.....    | 169 | 310.....          | 1047HD.....   | 210 |
| S85710.....      | 181 | S85931SL.....   | 136 | S880XE.....   | 172 | S92XN.....    | 169 | 100.....          | 1048HD.....   | 211 |
| S85710SL.....    | 182 | S85932SL.....   | 144 | S880XESL..... | 173 | S92XR.....    | 169 | 102.....          | 104XC.....    | 216 |
| S85710XC.....    | 165 | S85934SL.....   | 149 | S880XJ.....   | 172 | S93.....      | 201 | 104.....          | 104XE.....    | 216 |
| S85710XCSSL..... | 166 | S8600.....      | 201 | S880XJSL..... | 173 | S930.....     | 130 | 105.....          | 104XJ.....    | 216 |
| S85710XE.....    | 165 | S8600XC.....    | 173 | S880XN.....   | 172 | S930SL.....   | 131 | 108.....          | 104XN.....    | 216 |
| S85710XESL.....  | 166 | S8600XE.....    | 173 | S880XNSL..... | 173 | S9320.....    | 199 | 118.....          | 104XR.....    | 216 |
| S85710XJ.....    | 165 | S8600XJ.....    | 173 | S880XR.....   | 172 | S93203.....   | 193 | 128.....          | 1055HD.....   | 208 |
| S85710XJSL.....  | 166 | S8600XN.....    | 173 | S880XRSL..... | 173 | S93203XC..... | 169 | 130.....          | 1089SLHD..... | 218 |
| S85710XN.....    | 165 | S8600XR.....    | 173 | S881.....     | 192 | S93203XE..... | 169 | 131.....          | 108XC.....    | 216 |
| S85710XNSL.....  | 166 | S8601.....      | 199 | S881SL.....   | 194 | S93203XJ..... | 169 | 137.....          | 108XE.....    | 216 |
| S85710XR.....    | 165 | S8601SL.....    | 199 | S881XC.....   | 169 | S93203XN..... | 169 | 138.....          | 108XJ.....    | 216 |
| S85710XRSL.....  | 166 | S8601XCSSL..... | 173 | S881XCSL..... | 169 | S93203XR..... | 169 | 198.....          | 108XN.....    | 216 |
| S85720.....      | 181 | S8601XESL.....  | 173 | S881XE.....   | 169 | S9320XC.....  | 173 | 369.....          | 108XR.....    | 216 |
| S85720SL.....    | 182 | S8601XJSL.....  | 173 | S881XESL..... | 169 | S9320XE.....  | 173 | 571.....          | 1101HD.....   | 219 |
| S85720XCSSL..... | 166 | S8601XNSL.....  | 173 | S881XJ.....   | 169 | S9320XJ.....  | 173 | 610.....          | 1101XCHD..... | 216 |
| S85720XESL.....  | 166 | S8601XRSL.....  | 173 | S881XJSL..... | 169 | S9320XN.....  | 173 | 620.....          | 1101XEHD..... | 216 |
| S85720XJSL.....  | 166 | S8602.....      | 144 | S881XN.....   | 169 | S9320XR.....  | 173 | 626.....          | 1101XJHD..... | 216 |
| S85720XNSL.....  | 166 | S8602SL.....    | 144 | S881XNSL..... | 169 | S9341.....    | 130 | 916.....          | 1101XNHD..... | 216 |
| S85720XRSL.....  | 166 | S8604.....      | 133 | S881XR.....   | 169 | S9342.....    | 157 | 1006.....         | 1101XRHD..... | 216 |
| S8572SL.....     | 151 | S8604-A.....    | 133 | S881XRSL..... | 169 | S9343.....    | 127 | 1027.....         | 1102HD.....   | 217 |
| S85730.....      | 181 | S8605.....      | 194 | S882.....     | 192 | S9345.....    | 163 | 1028.....         | 1107HD.....   | 210 |
| S85730XC.....    | 165 | S8605SL.....    | 195 | S884.....     | 162 | S9347.....    | 154 | 1029.....         | 1110HD.....   | 215 |
| S85730XE.....    | 165 | S8605XC.....    | 170 | S884SL.....   | 163 | S9349.....    | 148 | 1200.....         | 1111HD.....   | 211 |
| S85730XJ.....    | 165 | S8605XE.....    | 170 | S887.....     | 133 | S9352.....    | 133 | 1201.....         | 1112HD.....   | 211 |
| S85730XN.....    | 165 | S8605XJ.....    | 170 | S887-A.....   | 133 | S9352-A.....  | 133 | 1202.....         | 1113HD.....   | 214 |
| S85730XR.....    | 165 | S8605XN.....    | 170 | S887SL.....   | 133 | S9353.....    | 136 | 1203.....         | 1114HD.....   | 208 |
| S8574.....       | 150 | S8605XR.....    | 170 | S887SL-A..... | 133 | S9354.....    | 144 | 5425.....         | 1114HD-A..... | 208 |
| S8579.....       | 151 | S8606.....      | 194 | S888.....     | 130 | S9355.....    | 138 | 03142HD.....      | 1115HD.....   | 209 |
| S8581.....       | 151 | S8606SL.....    | 195 | S888SL.....   | 131 | S9356.....    | 141 | 1001HD.....       | 1116HD.....   | 209 |
| S8583SL.....     | 151 | S8606XC.....    | 170 | S891.....     | 143 | S9357.....    | 146 | 1002HD.....       | 1117HD.....   | 207 |
| S85892.....      | 126 | S8606XE.....    | 170 | S891SL.....   | 144 | S936.....     | 130 | 1004HD.....       | 1118HD.....   | 213 |
| S85892SL.....    | 127 | S8606XJ.....    | 170 | S892.....     | 148 | S94.....      | 162 | 1005HD.....       | 1119HD.....   | 207 |
| S85893.....      | 136 | S8606XN.....    | 170 | S892SL.....   | 149 | S95.....      | 133 | 1006SL.....       | 1120HD.....   | 212 |
| S85893SL.....    | 136 | S8606XR.....    | 170 | S893.....     | 136 | S950.....     | 130 | 1007HD.....       | 1121HD.....   | 217 |
| S85895.....      | 153 | S8607.....      | 194 | S894.....     | 126 | S950SL.....   | 131 | 1007SLHD.....     | 1122HD.....   | 218 |
| S85895SL.....    | 154 | S8607SL.....    | 195 | S894SL.....   | 127 | S95-A.....    | 133 | 1008HD.....       | 1123HD.....   | 218 |
| S85896SL.....    | 149 | S8607XC.....    | 170 | S895.....     | 136 | S960.....     | 201 | 1009HD.....       | 1123HDXC..... | 216 |
| S85897.....      | 138 | S8607XE.....    | 170 | S895SL.....   | 136 | S962.....     | 141 | 1009SLHD.....     | 1123HDXE..... | 216 |
| S85898.....      | 138 | S8607XJ.....    | 170 | S896.....     | 199 | S962SL.....   | 142 | 100SL.....        | 1123HDXJ..... | 216 |
| S85898SL.....    | 139 | S8607XN.....    | 170 | S896XC.....   | 173 | S964.....     | 141 | 100XCSSL.....     | 1123HDXN..... | 216 |
| S85900.....      | 141 | S8607XR.....    | 170 | S896XE.....   | 173 | S964SL.....   | 142 | 100XCSL.....      | 1123HDXR..... | 216 |
| S85900SL.....    | 142 | S8608.....      | 195 | S896XJ.....   | 173 | S966.....     | 141 | 100XCSL.....      | 115HD.....    | 218 |
| S85901.....      | 146 | S8608XC.....    | 170 | S896XN.....   | 173 | S968.....     | 141 | 100XNSL.....      | 118XC.....    | 216 |
| S85902.....      | 153 | S8608XE.....    | 170 | S896XR.....   | 173 | S97.....      | 153 | 100XRSL.....      | 118XE.....    | 216 |
| S85902SL.....    | 154 | S8608XJ.....    | 170 | S897.....     | 201 | S970.....     | 141 | 1011HD.....       | 118XJ.....    | 216 |
| S85905.....      | 127 | S8608XN.....    | 170 | S89701.....   | 156 | S971.....     | 176 | 1020HD.....       | 118XN.....    | 216 |
| S85906.....      | 141 | S8608XR.....    | 170 | S8971.....    | 176 | S972.....     | 127 | 1021HD.....       | 118XR.....    | 216 |
| S85907.....      | 130 | S8675SL.....    | 194 | S8972.....    | 176 | S973.....     | 136 | 1022HD.....       | 1200SL.....   | 218 |
| S85908.....      | 144 | S867SL.....     | 157 | S898.....     | 195 | S975.....     | 126 | 1024HD.....       | 1201SL.....   | 218 |
| S85909.....      | 148 | S8682.....      | 175 | S898SL.....   | 196 | S975SL.....   | 127 | 1025HD.....       | 1202SL.....   | 218 |
| S85910SL.....    | 199 | S8682SL.....    | 176 | S90.....      | 198 | S976.....     | 141 | 1027SL.....       | 128XC.....    | 216 |
| S85910XCSSL..... | 173 | S8704.....      | 195 | S902.....     | 156 | S976SL.....   | 142 | 1029SL.....       | 128XE.....    | 216 |
| S85910XESL.....  | 173 | S8707.....      | 144 | S902SL.....   | 157 | S977.....     | 130 | 1031HD.....       | 128XJ.....    | 216 |
| S85910XJSL.....  | 173 | S8708.....      | 199 | S90SL.....    | 182 | S979.....     | 126 | 1031SLHD.....     | 128XN.....    | 216 |
| S85910XNSL.....  | 173 | S8708XC.....    | 173 | S90XC.....    | 172 | S980.....     | 141 | 1032HD.....       | 128XR.....    | 216 |
| S85910XRSL.....  | 173 | S8708XE.....    | 173 | S90XE.....    | 172 | S981.....     | 130 | 1032SLHD.....     | 130SL.....    | 217 |
| S85911SL.....    | 142 | S8708XJ.....    | 173 | S90XJ.....    | 172 | S982.....     | 143 | 1034HD.....       | 132HD.....    | 217 |
| S85912SL.....    | 127 | S8708XN.....    | 173 | S90XN.....    | 172 | S983.....     | 148 | 1035HD.....       | 132SLHD.....  | 217 |
| S85914SL.....    | 131 | S8708XR.....    | 173 | S90XR.....    | 172 | S985.....     | 141 | 1037HD.....       | 138SL.....    | 215 |
| S85915SL.....    | 133 | S8721.....      | 149 | S91.....      | 133 | S988.....     | 141 | 1037SLHD.....     | 139-A.....    | 208 |
| S85915SL-A.....  | 133 | S8735.....      | 154 | S912.....     | 153 | S989.....     | 162 | 1038HD.....       | 139SL.....    | 208 |
| S85916SL.....    | 136 | S8736.....      | 139 | S916.....     | 130 | S991.....     | 141 | 1038SLHD.....     | 139SL-A.....  | 208 |
| S85917SL.....    | 144 | S8752.....      | 193 | S916SL.....   | 130 | S992.....     | 199 | 1039HD.....       | 1400SLHD..... | 219 |
| S85918SL.....    | 139 | S85720XC.....   | 165 | S91-A.....    | 133 | S994.....     | 162 | 1039SLHD.....     | 1403HD.....   | 219 |
| S85920SL.....    | 154 | S85720XE.....   | 165 | S91SL.....    | 133 | S995.....     | 141 | 103HD.....        | 1405HD.....   | 219 |
| S85922SL.....    | 149 | S85720XJ.....   | 165 | S91SL-A.....  | 133 | S997.....     | 127 | 1040HD.....       | 1405SLHD..... | 219 |
| S85924SL.....    | 195 | S85720XN.....   | 165 | S92.....      | 192 | S998.....     | 146 | 1040SLHD.....     | 1406HD.....   | 219 |
| S85925SL.....    | 195 | S85720XR.....   | 165 | S925.....     | 176 | S999.....     | 148 | 1041HD.....       | 1408HD.....   | 219 |
| S85926SL.....    | 195 | S880.....       | 198 | S926.....     | 130 | SART.....     | 136 | 1041SLHD.....     | 1411HD.....   | 219 |
| S85927SL.....    | 127 | S880SL.....     | 199 | S92SL.....    | 179 | WLHRT.....    | 149 | 1042HD.....       | 150HD.....    | 219 |
|                  |     |                 |     | S92XC.....    | 169 |               |     | 1044HD.....       | 150SLHD.....  | 220 |

|                |     |                |     |                 |     |                   |     |               |     |                |     |
|----------------|-----|----------------|-----|-----------------|-----|-------------------|-----|---------------|-----|----------------|-----|
| 151HD.....     | 218 | 262HDXJ.....   | 216 | 6184SL.....     | 219 | 978HD.....        | 220 | 6184XNSL..... | 221 | TS108XN.....   | 221 |
| 151SLHD.....   | 218 | 262HDXN.....   | 216 | 6185SL.....     | 219 | 980HD.....        | 219 | 6184XRSL..... | 221 | TS108XR.....   | 221 |
| 153HD.....     | 220 | 262HDXR.....   | 216 | 6186SL.....     | 219 | 980HDXC.....      | 216 | 6185SL.....   | 224 | TS115.....     | 223 |
| 154HD.....     | 218 | 263HD.....     | 218 | 620SL.....      | 212 | 980HDXE.....      | 216 | 6185XCSL..... | 221 | TS118.....     | 225 |
| 1643HD.....    | 214 | 263HDXC.....   | 216 | 625HD.....      | 212 | 980HDXJ.....      | 216 | 6185XESL..... | 221 | TS118XC.....   | 221 |
| 1643SLHD.....  | 215 | 263HDXE.....   | 216 | 625SLHD.....    | 212 | 980HDXN.....      | 216 | 6185XJSL..... | 221 | TS118XE.....   | 221 |
| 1644HD.....    | 214 | 263HDXJ.....   | 216 | 626SL.....      | 214 | 980HDXR.....      | 216 | 6185XNSL..... | 221 | TS118XJ.....   | 221 |
| 1644SLHD.....  | 215 | 263HDXN.....   | 216 | 627HD.....      | 214 | 982HD.....        | 218 | 6185XRSL..... | 221 | TS118XN.....   | 221 |
| 1651HD.....    | 214 | 263HDXR.....   | 216 | 628HD.....      | 214 | 982HDXC.....      | 216 | 6186SL.....   | 224 | TS118XR.....   | 221 |
| 1651SL.....    | 214 | 263SLHD.....   | 218 | 628SLHD.....    | 214 | 982HDXE.....      | 216 | 6186XCSL..... | 221 | TS1200.....    | 223 |
| 1657HD.....    | 214 | 263SLHDXC..... | 216 | 630HD.....      | 214 | 982HDXJ.....      | 216 | 6186XESL..... | 221 | TS1201.....    | 223 |
| 1657SLHD.....  | 215 | 263SLHDXE..... | 216 | 631HD.....      | 214 | 982HDXN.....      | 216 | 6186XJSL..... | 221 | TS1202.....    | 223 |
| 1659HD.....    | 214 | 263SLHDXJ..... | 216 | 632HD.....      | 212 | 982HDXR.....      | 216 | 6186XNSL..... | 221 | TS1203.....    | 223 |
| 1660HD.....    | 214 | 263SLHDXN..... | 216 | 632SL.....      | 218 | 984HD.....        | 217 | 6186XRSL..... | 221 | TS128.....     | 223 |
| 1662HD.....    | 214 | 263SLHDXR..... | 216 | 6720SLHD.....   | 218 | 985HD.....        | 215 | 632SL.....    | 224 | TS128XC.....   | 221 |
| 19020T.....    | 219 | 289EHD.....    | 215 | 6720HDXCSL..... | 216 | 988HD.....        | 211 | 632XCSL.....  | 221 | TS128XE.....   | 221 |
| 19020T.....    | 220 | 289ESLHD.....  | 215 | 6720HDXESL..... | 216 | 989HD.....        | 212 | 632XESL.....  | 221 | TS128XJ.....   | 221 |
| 19055T.....    | 208 | 289HD.....     | 219 | 6720HDXJSL..... | 216 | 991HD.....        | 207 | 632XJSL.....  | 221 | TS128XN.....   | 221 |
| 19055T-A.....  | 208 | 289HDXC.....   | 216 | 6720HDXNSL..... | 216 | 996HD.....        | 208 | 632XNSL.....  | 221 | TS128XR.....   | 221 |
| 19080T.....    | 208 | 289HDXE.....   | 216 | 6720HDXRSL..... | 216 | 996HD-A.....      | 208 | 632XRSL.....  | 221 | TS130.....     | 222 |
| 19200T.....    | 219 | 289HDJ.....    | 216 | 704HD.....      | 219 | 999HD.....        | 213 | 818SL.....    | 225 | TS131.....     | 222 |
| 19200T.....    | 220 | 289HDXN.....   | 216 | 707HD.....      | 211 | AVRT.....         | 210 | 818XC.....    | 221 | TS132.....     | 222 |
| 19210T.....    | 220 | 289HDXR.....   | 216 | 708HD.....      | 220 | AXRT.....         | 215 | 818XCSL.....  | 222 | TS132SL.....   | 222 |
| 19220T.....    | 219 | 294HD.....     | 208 | 708HDXC.....    | 216 | BLHRT.....        | 208 | 818XE.....    | 221 | TS137.....     | 222 |
| 19220T.....    | 220 | 294HD-A.....   | 208 | 708HDXE.....    | 216 | BSHRT.....        | 207 | 818XESL.....  | 222 | TS1405SL.....  | 224 |
| 19520T.....    | 208 | 296HD.....     | 220 | 708HDJ.....     | 216 | BSRT.....         | 207 | 818XJ.....    | 221 | TS1408.....    | 224 |
| 19520T-A.....  | 208 | 296HDXC.....   | 216 | 708HDXN.....    | 216 | CNHRT.....        | 213 | 818XJSL.....  | 222 | TS1411.....    | 224 |
| 19720T.....    | 212 | 296HDXE.....   | 216 | 708HDXR.....    | 216 | CNRT.....         | 213 | 818XN.....    | 221 | TS150.....     | 225 |
| 19730T.....    | 212 | 296HDJ.....    | 216 | 721HD.....      | 212 | FWRT.....         | 210 | 818XNSL.....  | 222 | TS150SL.....   | 225 |
| 19740T.....    | 211 | 296HDXN.....   | 216 | 735HD.....      | 213 | KNRT.....         | 214 | 818XR.....    | 221 | TS151.....     | 223 |
| 19750T.....    | 211 | 296HDXR.....   | 216 | 736HD.....      | 210 | RSRT.....         | 212 | 818XRSL.....  | 222 | TS151SL.....   | 224 |
| 19800T.....    | 208 | 296SLHD.....   | 220 | 752HD.....      | 218 | SART.....         | 209 | 8206XC.....   | 221 | TS153.....     | 225 |
| 19810T.....    | 208 | 296SLHDXC..... | 216 | 916SL.....      | 208 | TS572SL.....      | 212 | 8206XE.....   | 221 | TS154.....     | 223 |
| 19820T.....    | 208 | 296SLHDXE..... | 216 | 930HD.....      | 207 | WLHRT.....        | 212 | 8206XJ.....   | 221 | TS198.....     | 224 |
| 198SL.....     | 219 | 296SLHDXJ..... | 216 | 930SLHD.....    | 208 | <b>Traditions</b> |     | 8206XN.....   | 221 | TS206.....     | 225 |
| 203HD.....     | 220 | 296SLHDXN..... | 216 | 936HD.....      | 208 | 800.....          | 226 | 8206XR.....   | 221 | TS206XC.....   | 221 |
| 205HD.....     | 220 | 296SLHDXR..... | 216 | 936SLHD.....    | 208 | 808.....          | 223 | 828SL.....    | 224 | TS206XE.....   | 221 |
| 206EHD.....    | 215 | 3000-2C.....   | 218 | 950HD.....      | 207 | 810.....          | 226 | 829SL.....    | 222 | TS206XJ.....   | 221 |
| 206HD.....     | 219 | 3000-3C.....   | 218 | 950SLHD.....    | 208 | 818.....          | 225 | 83000-2C..... | 224 | TS206XN.....   | 221 |
| 206HDXC.....   | 216 | 3000-4C.....   | 219 | 956SLHD.....    | 208 | 828.....          | 223 | 83000-3C..... | 224 | TS206XR.....   | 221 |
| 206HDXE.....   | 216 | 3000-6C.....   | 219 | 959HD.....      | 219 | 829.....          | 222 | 83000-4C..... | 224 | TS210.....     | 226 |
| 206HDJ.....    | 216 | 309HD.....     | 207 | 959HDXC.....    | 216 | 896.....          | 225 | 83000-6C..... | 224 | TS210SL.....   | 225 |
| 206HDXN.....   | 216 | 310SL.....     | 207 | 959HDXCSL.....  | 216 | 8132.....         | 222 | 8321XC.....   | 221 | TS210XCSL..... | 222 |
| 206HDXR.....   | 216 | 311HD.....     | 207 | 959HDXE.....    | 216 | 8145.....         | 224 | 8321XE.....   | 221 | TS210XESL..... | 222 |
| 2109HD.....    | 217 | 311SLHD.....   | 207 | 959HDXESL.....  | 216 | 8206.....         | 225 | 8321XJ.....   | 221 | TS210XJSL..... | 222 |
| 210HD.....     | 220 | 347HD.....     | 209 | 959HDJ.....     | 216 | 8317.....         | 223 | 8321XN.....   | 221 | TS210XNSL..... | 222 |
| 210SLHD.....   | 220 | 369SL.....     | 209 | 959HDXJSL.....  | 216 | 8321.....         | 223 | 8321XR.....   | 221 | TS210XRSL..... | 222 |
| 210SLHDXC..... | 216 | 371HD.....     | 209 | 959HDXN.....    | 216 | 8322.....         | 223 | 8614SL.....   | 224 | TS214.....     | 226 |
| 210SLHDXE..... | 216 | 371SLHD.....   | 209 | 959HDXNSL.....  | 216 | 8323.....         | 223 | 86185SL.....  | 224 | TS236.....     | 223 |
| 210SLHDXJ..... | 216 | 375HD.....     | 209 | 959HDXR.....    | 216 | 8324.....         | 223 | 86186SL.....  | 224 | TS237.....     | 223 |
| 210SLHDXN..... | 216 | 400HD.....     | 213 | 959HDXRSL.....  | 216 | 8704.....         | 224 | 8708XC.....   | 221 | TS243.....     | 222 |
| 210SLHDXR..... | 216 | 416SL.....     | 213 | 959SLHD.....    | 220 | 8708.....         | 225 | 8708XE.....   | 221 | TS255.....     | 223 |
| 2110HD.....    | 217 | 426HD.....     | 213 | 961HD.....      | 218 | 8752.....         | 223 | 8708XJ.....   | 221 | TS256.....     | 225 |
| 2111HD.....    | 218 | 430HD.....     | 213 | 961HDXC.....    | 216 | 100SL.....        | 225 | 8708XN.....   | 221 | TS256XC.....   | 221 |
| 211HD.....     | 208 | 430SLHD.....   | 213 | 961HDXE.....    | 216 | 100XCSL.....      | 222 | 8708XR.....   | 221 | TS256XE.....   | 221 |
| 211HD-A.....   | 208 | 450HD.....     | 213 | 961HDJ.....     | 216 | 100XESL.....      | 222 | 896XC.....    | 222 | TS256XJ.....   | 221 |
| 236HD.....     | 218 | 450SLHD.....   | 213 | 961HDXN.....    | 216 | 100XJSL.....      | 222 | 896XE.....    | 222 | TS256XN.....   | 221 |
| 237HD.....     | 218 | 453HD.....     | 213 | 961HDXR.....    | 216 | 100XNSL.....      | 222 | 896XJ.....    | 222 | TS256XR.....   | 221 |
| 243HD.....     | 217 | 454HD.....     | 213 | 962HD.....      | 207 | 100XRSL.....      | 222 | 896XN.....    | 222 | TS262.....     | 223 |
| 250HD.....     | 215 | 4572SLHD.....  | 218 | 963HD.....      | 215 | 1200SL.....       | 223 | 896XR.....    | 222 | TS262XC.....   | 221 |
| 250SLHD.....   | 215 | 5425SL.....    | 217 | 964SLHD.....    | 213 | 1201SL.....       | 223 | TS100.....    | 226 | TS262XE.....   | 221 |
| 253HD.....     | 215 | 544HD.....     | 212 | 965HD.....      | 208 | 1202SL.....       | 223 | TS102.....    | 225 | TS262XJ.....   | 221 |
| 255HD.....     | 218 | 546SLHD.....   | 212 | 965HD-A.....    | 208 | 130SL.....        | 222 | TS104.....    | 225 | TS262XN.....   | 221 |
| 256HD.....     | 220 | 576HD.....     | 212 | 965SLHD.....    | 208 | 19020T.....       | 225 | TS104XC.....  | 221 | TS262XR.....   | 221 |
| 256HDXC.....   | 216 | 578HD.....     | 212 | 965SLHD-A.....  | 208 | 19200T.....       | 225 | TS104XE.....  | 221 | TS263.....     | 223 |
| 256HDXE.....   | 216 | 582HD.....     | 212 | 966SLHD.....    | 214 | 19210T.....       | 225 | TS104XJ.....  | 221 | TS263SL.....   | 224 |
| 256HDJ.....    | 216 | 584SLHD.....   | 212 | 967HD.....      | 213 | 19220T.....       | 225 | TS104XN.....  | 221 | TS263XC.....   | 221 |
| 256HDXN.....   | 216 | 588HD.....     | 212 | 968HD.....      | 209 | 198SL.....        | 224 | TS104XR.....  | 221 | TS263XCSL..... | 221 |
| 256HDXR.....   | 216 | 6023HD.....    | 218 | 969HD.....      | 220 | 6184SL.....       | 224 | TS105.....    | 225 | TS263XE.....   | 221 |
| 260HD.....     | 215 | 610SL.....     | 211 | 970SLHD.....    | 220 | 6184KCSL.....     | 221 | TS108.....    | 223 | TS263XESL..... | 221 |
| 262HD.....     | 218 | 613HD.....     | 211 | 971SLHD.....    | 209 | 6184XESL.....     | 221 | TS108XC.....  | 221 | TS263XJ.....   | 221 |
| 262HDXC.....   | 216 | 615HD.....     | 211 | 975SLHD.....    | 208 | 6184XJSL.....     | 221 | TS108XE.....  | 221 | TS263XJSL..... | 221 |
| 262HDXE.....   | 216 | 615SLHD.....   | 211 | 977SLHD.....    | 213 |                   |     | TS108XJ.....  | 221 | TS263XN.....   | 221 |



# Fire

|                 |     |
|-----------------|-----|
| TS263XNSL.....  | 221 |
| TS263XR.....    | 221 |
| TS263XRSL.....  | 221 |
| TS296.....      | 225 |
| TS289.....      | 225 |
| TS289XC.....    | 221 |
| TS289XE.....    | 221 |
| TS289XJ.....    | 221 |
| TS289XN.....    | 221 |
| TS289XR.....    | 221 |
| TS290.....      | 226 |
| TS291.....      | 225 |
| TS296SL.....    | 225 |
| TS296XC.....    | 222 |
| TS296XCSSL..... | 222 |
| TS296XE.....    | 222 |
| TS296XESL.....  | 222 |
| TS296XJ.....    | 222 |
| TS296XJSL.....  | 222 |
| TS296XN.....    | 222 |
| TS296XNSL.....  | 222 |
| TS296XR.....    | 222 |
| TS296XRSL.....  | 222 |
| TS3000-2C.....  | 224 |
| TS3000-3C.....  | 224 |
| TS3000-4C.....  | 224 |
| TS3000-6C.....  | 224 |
| TS704.....      | 224 |
| TS708.....      | 225 |
| TS708XC.....    | 221 |
| TS708XE.....    | 221 |
| TS708XJ.....    | 221 |
| TS708XN.....    | 221 |
| TS708XR.....    | 221 |
| TS752.....      | 223 |

## Classic-Craft Mahogany Collection™

|              |     |
|--------------|-----|
| CCMF060..... | 228 |
| CCMF701..... | 228 |
| CCMF890..... | 228 |

## Classic-Craft Rustic Collection™

|                |     |
|----------------|-----|
| CCRF040.....   | 229 |
| CCRF040F.....  | 229 |
| CCRF200.....   | 229 |
| CCRF200A.....  | 229 |
| CCRF205.....   | 229 |
| CCRF205A.....  | 229 |
| CCRF8005.....  | 229 |
| CCRF8005A..... | 229 |
| CCRF8040.....  | 229 |
| CCRF8040F..... | 229 |
| CCRF8200.....  | 229 |
| CCRF8200A..... | 229 |
| CCRF8205.....  | 229 |
| CCRF8205A..... | 229 |
| CCRF8220.....  | 229 |
| CCRF8220R..... | 229 |
| CCRF8222.....  | 229 |
| CCRF8225.....  | 229 |
| CCRF8225R..... | 229 |

## Classic-Craft Oak Collection™

|             |     |
|-------------|-----|
| CCF060..... | 229 |
| CCF810..... | 229 |
| CCF831..... | 229 |
| CCF91.....  | 229 |

## Classic-Craft Canvas Collection.

|                |     |
|----------------|-----|
| CCVF050.....   | 230 |
| CCVF060.....   | 230 |
| CCVF200.....   | 230 |
| CCVF205.....   | 229 |
| CCVF205A.....  | 229 |
| CCVF220.....   | 230 |
| CCVF400.....   | 229 |
| CCVF455.....   | 230 |
| CCVF455A.....  | 230 |
| CCVF8060.....  | 230 |
| CCVF8205.....  | 229 |
| CCVF8205A..... | 229 |
| CCVF8220.....  | 230 |
| CCVF831.....   | 230 |

## Fiber-Classic Mahogany Collection™

|              |     |
|--------------|-----|
| FMF100.....  | 230 |
| FMF134.....  | 230 |
| FMF205.....  | 230 |
| FMF220.....  | 230 |
| FMF31.....   | 230 |
| FMF60.....   | 230 |
| FMF600.....  | 230 |
| FMF755.....  | 230 |
| FMF8100..... | 230 |
| FMF860.....  | 230 |

## Fiber-Classic Oak Collection.

|             |     |
|-------------|-----|
| FCF100..... | 230 |
| FCF134..... | 230 |
| FCF160..... | 230 |
| FCF31.....  | 230 |
| FCF755..... | 230 |
| FCF808..... | 230 |
| FCF809..... | 230 |

|              |     |
|--------------|-----|
| FCF8100..... | 230 |
| FCF8160..... | 230 |
| FCF862.....  | 230 |

## Smooth-Star.

|              |     |
|--------------|-----|
| SSF100.....  | 231 |
| SSF11.....   | 231 |
| SSF160.....  | 231 |
| SSF200.....  | 231 |
| SSF205.....  | 231 |
| SSF220.....  | 231 |
| SSF31.....   | 231 |
| SSF600.....  | 231 |
| SSF755.....  | 231 |
| SSF8100..... | 231 |
| SSF8160..... | 231 |
| SSF8200..... | 231 |
| SSF8205..... | 231 |
| SSF8220..... | 231 |
| SSF831.....  | 231 |
| SSF8600..... | 231 |
| SSF93.....   | 231 |
| SSF960.....  | 231 |

## Profiles™

|             |     |
|-------------|-----|
| 100.....    | 231 |
| 1005HD..... | 231 |
| 203HD.....  | 231 |
| 205HD.....  | 231 |
| 210HD.....  | 231 |
| 969HD.....  | 231 |
| 978HD.....  | 231 |

## Traditions

|            |     |
|------------|-----|
| TS100..... | 231 |
| TS210..... | 231 |
| TS214..... | 231 |
| TS290..... | 231 |

## Steel Edge

|               |     |
|---------------|-----|
| SE100.....    | 228 |
| SE1005HD..... | 228 |
| SE210HD.....  | 228 |
| SE514.....    | 228 |
| SE969HD.....  | 228 |
| SE978HD.....  | 228 |

# Pulse®

## Ari

|            |     |
|------------|-----|
| S2AX.....  | 237 |
| S2CL.....  | 237 |
| S2RS.....  | 237 |
| S2XC.....  | 237 |
| S2XE.....  | 237 |
| S2XJ.....  | 237 |
| S2XN.....  | 237 |
| S2XR.....  | 237 |
| S83AX..... | 237 |
| S83CL..... | 237 |
| S83RS..... | 237 |
| S83XC..... | 237 |
| S83XE..... | 237 |
| S83XJ..... | 237 |
| S83XN..... | 237 |
| S83XR..... | 237 |

## Linea

|             |     |
|-------------|-----|
| S1CL.....   | 239 |
| S1.....     | 239 |
| S1AV.....   | 238 |
| S1AX.....   | 239 |
| S1BL.....   | 237 |
| S1BS.....   | 237 |
| S1FW.....   | 238 |
| S1L.....    | 239 |
| S1LAV.....  | 238 |
| S1LAX.....  | 239 |
| S1LBL.....  | 237 |
| S1LBS.....  | 237 |
| S1LCL.....  | 239 |
| S1LFW.....  | 238 |
| S1LRS.....  | 239 |
| S1LSA.....  | 238 |
| S1LSG.....  | 238 |
| S1LSN.....  | 237 |
| S1LSNA..... | 237 |
| S1LTX.....  | 238 |
| S1LXC.....  | 239 |
| S1LXE.....  | 239 |
| S1LXJ.....  | 239 |
| S1LXN.....  | 239 |
| S1LXR.....  | 239 |
| S1R.....    | 239 |
| S1RAV.....  | 238 |
| S1RAX.....  | 239 |
| S1RBL.....  | 237 |
| S1RBS.....  | 237 |
| S1RCL.....  | 239 |
| S1RFX.....  | 238 |
| S1RRS.....  | 239 |
| S1RS.....   | 239 |
| S1RSA.....  | 238 |
| S1RSG.....  | 238 |
| S1RSN.....  | 237 |
| S1RSNA..... | 237 |
| S1RTX.....  | 238 |
| S1RXC.....  | 239 |
| S1RXE.....  | 239 |
| S1RXJ.....  | 239 |
| S1RXN.....  | 239 |
| S1RXR.....  | 239 |
| S1SA.....   | 238 |
| S1SG.....   | 238 |
| S1SN.....   | 237 |
| S1SNA.....  | 237 |
| S1XC.....   | 239 |
| S1XE.....   | 239 |
| S1XJ.....   | 239 |
| S1XN.....   | 239 |
| S1XR.....   | 239 |
| S81.....    | 239 |

|              |     |
|--------------|-----|
| S81AX.....   | 239 |
| S81BL.....   | 237 |
| S81BS.....   | 237 |
| S81CL.....   | 239 |
| S81L.....    | 239 |
| S81LAX.....  | 239 |
| S81LBL.....  | 237 |
| S81LBS.....  | 237 |
| S81LCL.....  | 239 |
| S81LRS.....  | 238 |
| S81LSA.....  | 239 |
| S81LSG.....  | 238 |
| S81LSNA..... | 237 |
| S81LXC.....  | 239 |
| S81LXE.....  | 239 |
| S81LXJ.....  | 239 |
| S81LXN.....  | 239 |
| S81LXR.....  | 239 |
| S81R.....    | 239 |
| S81RAX.....  | 239 |
| S81RBL.....  | 237 |
| S81RBS.....  | 237 |
| S81RCL.....  | 239 |
| S81RRS.....  | 239 |
| S81RS.....   | 239 |
| S81RSA.....  | 238 |
| S81RSG.....  | 238 |
| S81RSNA..... | 237 |
| S81RXC.....  | 239 |
| S81RXE.....  | 239 |
| S81RXJ.....  | 239 |
| S81RXN.....  | 239 |
| S81RXR.....  | 239 |
| S81SA.....   | 238 |
| S81SG.....   | 238 |
| S81SNA.....  | 237 |
| S81XC.....   | 239 |
| S81XE.....   | 239 |
| S81XJ.....   | 239 |
| S81XN.....   | 239 |
| S81XR.....   | 239 |

## Echo

|            |     |
|------------|-----|
| S4AX.....  | 240 |
| S4CL.....  | 241 |
| S4LAX..... | 240 |
| S4LCL..... | 241 |
| S4LXC..... | 241 |
| S4LXE..... | 241 |
| S4LXJ..... | 241 |
| S4LXN..... | 241 |
| S4LXR..... | 241 |
| S4RAX..... | 240 |
| S4RCL..... | 241 |
| S4RXC..... | 241 |
| S4RXE..... | 241 |
| S4RXJ..... | 241 |
| S4RXN..... | 241 |
| S4RXR..... | 241 |
| S4XC.....  | 241 |
| S4XE.....  | 241 |
| S4XJ.....  | 241 |
| S4XN.....  | 241 |
| S4XR.....  | 241 |
| S5AX.....  | 240 |
| S5CL.....  | 242 |
| S5LAX..... | 240 |
| S5LCL..... | 241 |
| S5LXC..... | 241 |
| S5LXE..... | 241 |
| S5LXJ..... | 241 |
| S5LXN..... | 241 |
| S5LXR..... | 241 |

|              |     |
|--------------|-----|
| S5RAX.....   | 240 |
| S5RCL.....   | 242 |
| S5RXC.....   | 242 |
| S5RXE.....   | 242 |
| S5RXJ.....   | 242 |
| S5RXN.....   | 242 |
| S5RXR.....   | 242 |
| S5XC.....    | 242 |
| S5XE.....    | 242 |
| S5XJ.....    | 242 |
| S5XN.....    | 242 |
| S5XR.....    | 242 |
| S810AX.....  | 241 |
| S810CL.....  | 242 |
| S810LAX..... | 241 |
| S810LCL..... | 242 |
| S810LXC..... | 242 |
| S810LXE..... | 242 |
| S810LXJ..... | 242 |
| S810LXN..... | 242 |
| S810LXR..... | 242 |
| S810RAX..... | 241 |
| S810RCL..... | 242 |
| S810RXC..... | 242 |
| S810RXE..... | 242 |
| S810RXJ..... | 242 |
| S810RXN..... | 242 |
| S810RXX..... | 242 |
| S810XC.....  | 242 |
| S810XE.....  | 242 |
| S810XJ.....  | 242 |
| S810XN.....  | 242 |
| S810XR.....  | 242 |
| S811AX.....  | 241 |
| S811CL.....  | 242 |
| S811LAX..... | 241 |
| S811LCL..... | 242 |
| S811LXC..... | 242 |
| S811LXE..... | 242 |
| S811LXJ..... | 242 |
| S811LXN..... | 242 |
| S811LXR..... | 242 |
| S811RAX..... | 241 |
| S811RCL..... | 242 |
| S811RXC..... | 242 |
| S811RXE..... | 242 |
| S811RXJ..... | 242 |
| S811RXN..... | 242 |
| S811RXX..... | 242 |
| S811XC.....  | 242 |
| S811XE.....  | 242 |
| S811XJ.....  | 242 |
| S811XN.....  | 242 |
| S811XR.....  | 242 |
| S84AX.....   | 240 |
| S84CL.....   | 241 |
| S84LAX.....  | 240 |
| S84LCL.....  | 241 |
| S84LXC.....  | 241 |
| S84LXE.....  | 241 |
| S84LXJ.....  | 241 |
| S84LXN.....  | 241 |
| S84LXR.....  | 241 |
| S84RAX.....  | 240 |
| S84RCL.....  | 241 |
| S84RXC.....  | 241 |
| S84RXE.....  | 241 |
| S84RXJ.....  | 241 |
| S84RXN.....  | 241 |
| S84RXX.....  | 241 |
| S84XC.....   | 241 |
| S84XE.....   | 241 |
| S84XJ.....   | 241 |

Pulse *Continued*

|        |     |                  |     |            |     |
|--------|-----|------------------|-----|------------|-----|
| S84XN  | 241 | S9LXR            | 242 | S8165SL    | 243 |
| S84XR  | 241 | S9RAX            | 240 | S84586SL   | 243 |
| S85AX  | 240 | S9RCL            | 242 | S84AXSL    | 243 |
| S85CL  | 242 | S9RXC            | 242 | S84CLSL    | 244 |
| S85LAX | 240 | S9RXE            | 242 | S84XCSL    | 244 |
| S85LCL | 241 | S9RXJ            | 242 | S84XESL    | 244 |
| S85LXC | 241 | S9RXN            | 242 | S84XJSL    | 244 |
| S85LXE | 241 | S9RXX            | 242 | S84XNSL    | 244 |
| S85LXJ | 241 | S9XC             | 242 | S84XRSL    | 244 |
| S85LXN | 241 | S9XE             | 242 | S8572SL    | 243 |
| S85LXR | 241 | S9XJ             | 242 | S85927SL   | 243 |
| S85RAX | 240 | S9XN             | 242 | S85928SL   | 243 |
| S85RCL | 242 | S9XR             | 242 | S85931SL   | 243 |
| S85RXC | 242 |                  |     | S85932SL   | 243 |
| S85RXE | 242 | <b>Sidelites</b> |     | S85933SL   | 243 |
| S85RXJ | 242 | S10AXSL          | 243 | S85933SL-A | 243 |
| S85RXN | 242 | S10CLSL          | 244 | S85AXSL    | 243 |
| S85RXX | 242 | S10XCSL          | 244 | S85CLSL    | 244 |
| S85XC  | 242 | S10XESL          | 244 | S85XCSL    | 244 |
| S85XE  | 242 | S10XJSL          | 244 | S85XESL    | 244 |
| S85XJ  | 242 | S10XNSL          | 244 | S85XJSL    | 244 |
| S85XN  | 242 | S10XRSL          | 244 | S85XNSL    | 244 |
| S85XR  | 242 | S1651SL          | 243 | S85XRSL    | 244 |
| S86AX  | 240 | S4570SL          | 243 | S86AXSL    | 243 |
| S86CL  | 242 | S4AXSL           | 243 | S86CLSL    | 244 |
| S86LAX | 240 | S4CLSL           | 244 | S86XCSL    | 244 |
| S86LCL | 242 | S4XCSL           | 244 | S86XESL    | 244 |
| S86LXC | 242 | S4XESL           | 244 | S86XJSL    | 244 |
| S86LXE | 242 | S4XJSL           | 244 | S86XNSL    | 244 |
| S86LXJ | 242 | S4XNSL           | 244 | S86XRSL    | 244 |
| S86LXN | 242 | S4XRSL           | 244 | S9AXSL     | 243 |
| S86LXR | 242 | S572SL           | 243 | S9CLSL     | 244 |
| S86RAX | 240 | S5AXSL           | 243 | S9XCSL     | 244 |
| S86RCL | 242 | S5CLSL           | 244 | S9XESL     | 244 |
| S86RXC | 242 | S5XCSL           | 244 | S9XJSL     | 244 |
| S86RXE | 242 | S5XESL           | 244 | S9XNSL     | 244 |
| S86RXJ | 242 | S5XJSL           | 244 | S9XRSL     | 244 |
| S86RXN | 242 | S5XNSL           | 244 |            |     |
| S86RXX | 242 | S5XRSL           | 244 |            |     |
| S86XC  | 242 | S601SL           | 243 |            |     |
| S86XE  | 242 | S601XCSL         | 243 |            |     |
| S86XJ  | 242 | S601XESL         | 243 |            |     |
| S86XN  | 242 | S601XJSL         | 243 |            |     |
| S86XR  | 242 | S601XNSL         | 243 |            |     |
| S8AX   | 240 | S601XRSL         | 243 |            |     |
| S8CL   | 242 | S602SL           | 243 |            |     |
| S8LAX  | 240 | S604SL           | 243 |            |     |
| S8LCL  | 242 | S604SL-A         | 243 |            |     |
| S8LXC  | 242 | S6127SL          | 243 |            |     |
| S8LXE  | 242 | S6128SL          | 243 |            |     |
| S8LXJ  | 242 | S6130SL          | 243 |            |     |
| S8LXN  | 242 | S6134SL          | 243 |            |     |
| S8LXR  | 242 | S6135SL          | 243 |            |     |
| S8RAX  | 240 | S81086SL         | 243 |            |     |
| S8RCL  | 242 | S81086XCSL       | 243 |            |     |
| S8RXC  | 242 | S81086XESL       | 243 |            |     |
| S8RXE  | 242 | S81086XJSL       | 243 |            |     |
| S8RXJ  | 242 | S81086XNSL       | 243 |            |     |
| S8RXN  | 242 | S81086XRSL       | 243 |            |     |
| S8RXX  | 242 | S810AXSL         | 243 |            |     |
| S8XC   | 242 | S810CLSL         | 244 |            |     |
| S8XE   | 242 | S810XCSL         | 244 |            |     |
| S8XJ   | 242 | S810XESL         | 244 |            |     |
| S8XN   | 242 | S810XJSL         | 244 |            |     |
| S8XR   | 242 | S810XNSL         | 244 |            |     |
| S9AX   | 240 | S810XRSL         | 244 |            |     |
| S9CL   | 242 | S811AXSL         | 243 |            |     |
| S9LAX  | 240 | S811CLSL         | 244 |            |     |
| S9LCL  | 242 | S811XCSL         | 244 |            |     |
| S9LXC  | 242 | S811XESL         | 244 |            |     |
| S9LXE  | 242 | S811XJSL         | 244 |            |     |
| S9LXJ  | 242 | S811XNSL         | 244 |            |     |
| S9LXN  | 242 | S811XRSL         | 244 |            |     |



Top: Smooth-Star Door – S8200; Granite Glass, Sidelites – S81086XNSL  
 Bottom: Smooth-Star, Concorde Glass, Door – S97, Sidelites – S416SL





Top: Fiber-Classic Mahogany Collection, Sedona Art Glass, Door – FCM604-A, Sidelites – FCM816SL-A, Transom – 19520T-A  
Bottom Left: Classic-Craft Mahogany Collection, Longford Glass, Door – CCM703, Sidelites – CCM3303SL, Transom – LFET  
Bottom Right: Classic-Craft Rustic Collection Door – CCR205; Low-E Glass, Sidelites – CCR3400SL





Top: Fiber-Classic Mahogany Collection, Blackstone Glass, Door – FCM765; Rainglass, Sidelites – FCM12101XRSL  
Middle Right: Fiber-Classic Oak Collection, Saratoga Glass, Door – 81956P  
Bottom Right: Classic-Craft Canvas Collection, Lucerna Glass, Doors – CCV22022, ©TheHouseDesigners.com





Top Left: Fiber-Classic Mahogany Collection, Maple Park Glass, Door – FCM609  
Middle Left: Classic-Craft Mahogany Collection, Ashurst Glass, Door – CCM305, Sidelites – CCM3305SL, Transom – ASRT  
Bottom: Classic-Craft American Style Collection, Low-E Glass with SDLs, Door – CCA8220; Smooth-Star, Satin Etch Glass, Sidelites – S8601XESL



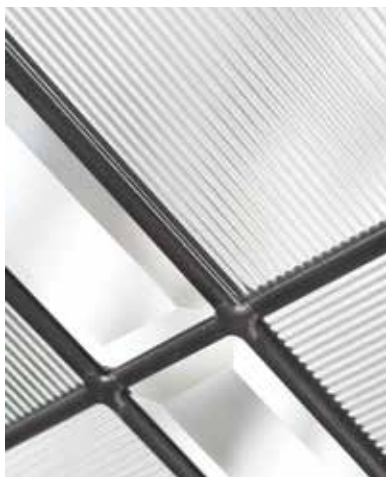

Top: Smooth-Star, Clear Glass with GBGs, Door – S82104  
 Middle Right: Pulse Ari, Chinchilla Glass with Scrolled Lite Frame, Door – S2XJ  
 Bottom Right: Smooth-Star, Satin Etch Glass with SDLs, Door – S4813XE

## Tools of the Trade

Check out these helpful resources for dealers, builders and remodelers.

### Architectural Home Styles Guide

Get inspired to choose entry doors by design with our interactive guide to popular home styles. [www.homestyles.thermatru.com](http://www.homestyles.thermatru.com).



### Unlock the Opportunities

Learn about new products and the power of curb appeal, and enter for a chance to win prizes at [www.unlocktheopportunities.com](http://www.unlocktheopportunities.com).

Promotion runs January 2–April 30, 2017.



### National Home Valuation Study

A stylish new Therma-Tru entry door can increase your home's perceived value by 4.2% or \$18,750 on average.\* Learn more and download promotional materials at [www.thermatru.com/curbappeal](http://www.thermatru.com/curbappeal).



### DoorWays™ App

The power to create the perfect entrance is at your fingertips – it's easier than ever to design and visualize entrances at [www.thermatru.com/doorways](http://www.thermatru.com/doorways).



### Consumers Digest Best Buy

Order free, ready-to-use promotional material to promote Classic-Craft and Fiber-Classic in your showroom at [www.thermatru.com/trade-professionals/consumersdigest](http://www.thermatru.com/trade-professionals/consumersdigest).



\*Based on a nationwide survey of consumers' estimates of perceived home value based on exterior appearance. Not based on actual home sales. Results may vary based on region and home style. Therma-Tru's "National Home Valuation Study" was commissioned by Therma-Tru in 2015 and conducted by TNS, an independent provider of internet-based research.

Apple and the Apple logo are trademarks of Apple Inc., registered in the U.S. and other countries. App Store is a service mark of Apple Inc. Android and Google Play are trademarks of Google, Inc.





# THERMA-TRU<sup>®</sup> DOORS

[www.thermatru.com](http://www.thermatru.com)

1-800-THERMA-TRU (843-7628)

1750 Indian Wood Circle

Maumee, OH 43537



Cover: Classic-Craft Oak Collection, Arborwatch Glass,  
Door – CC1423, Sidelites – CC1423SL, Transom – ABRT  
Top: Smooth-Star, Low-E Glass with SDLs, Door – S4814,  
Sidelites – S4812SL

Bottom Left: Smooth-Star, Internal Blinds, Door – S8132

Bottom Right: Smooth-Star, Satin Etch Glass with SDLs,  
Door – S5710XE, Sidelite – S5710XESL, ©TheHouseDesigners.com